

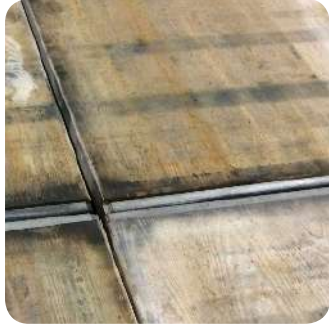

# MATERIAL SHEETS

## REUSE TOOLKIT





## MATERIAL SHEETS: GENERAL INTRODUCTION

### LANDSCAPING AND PAVING

- Natural stone setts
- Natural stone kerb
- Clay pavers (Clinker)
- Steenchotten formwork panel
- Ship timber



### STRUCTURE AND SHELL

- Solid structural timber with rectangular cross-section
- Glued laminated timber structural elements
- Steel beams
- Barnwood
- Solid clay brick
- Clay roof tile
- Roofing elements in natural slate
- Natural stone sill
- Natural stone wall copings
- Natural stone wall covering slab



### WOODWORK

- Interior fire doors
- Interior door - Panelled wooden door

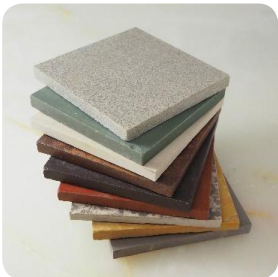

### INTERIOR FINISHINGS

- Ceramic wall tiles
- Cement based tiles
- Unglazed terracotta tiles
- Unglazed porcelain tiles
- Solid wood floors
- Raised access floor
- Carpet tiles
- Natural stone flooring slab
- Natural stone shelf



### EQUIPMENT

- Toilet bowl
- Suspended urinal
- Washbasins (and slop sinks) for individual and collective use
- Cast iron radiators
- Sheet steel, stainless steel and aluminium radiators

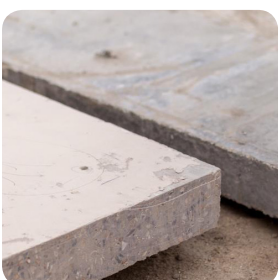

### CEMENT CONCRETE PRODUCTS

- Introduction to the reuse of cement concrete products
- Concrete rubble
- Concrete pavers and slabs
- Concrete shear wall



**Disclaimer**

This sheet is intended for designers, specifiers and other members of construction project teams wishing to reuse this building material or product. It is part of a collection of sheets aimed at bringing together the available information to date that is likely to facilitate the reuse of building materials and products.

This sheet has been produced by Rotor vzw/asbl within the framework of the Interreg FCRBE project - Facilitating the Circulation of Reclaimed Building Elements, supported by the entire project partnership. Sources of information include the experience of reclamation dealers and involved project partners, lessons learned from exemplary projects, available technical documentation, etc.

The sheets have been produced between 2019 and 2021. As the reclamation sector is evolving, some information, notably regarding pricing and availability, may change over the time. When the text refers to European standards, it is up to the project team to refer, if necessary, to their national implementations and local specificities.

It is important to note that the information presented here is not exhaustive or intended to replace the expertise of professionals. Specific questions are always project related and should be treated as such.

The complete collection of sheets (including the introductory sheet) is freely available from different reference websites (a.o. [opalis.eu](http://opalis.eu), [nweurope.eu/fcrbe](http://nweurope.eu/fcrbe), [futureuse.co.uk](http://futureuse.co.uk)).

Non-exhaustive directories of dealers in reclaimed building materials are available on [www.opalis.eu](http://www.opalis.eu) and [www.salvoweb.com](http://www.salvoweb.com).

---

Interreg FCRBE partnership: Bellastock (FR), the Belgian Building Research Institute / BBRI (BE), Brussels Environment (BE), the Scientific and Technical Center of Building / CSTB (FR), Confederation of Construction (BE), Rotor (BE), Salvo (UK) and University of Brighton (UK).

The information contained in this document does not necessarily reflect the position of all the FCRBE project partners nor that of the funding authorities.

Unless explicitly stated otherwise, the content of these sheets is credited in the Creative Commons Attribution NonCommercial – Share Alike format (CCBY-NC-SA).



Unless explicitly stated, the images used in this document belong to © Rotor vzw/asbl or © Opalis. Any other image has been the subject of a systematic request for authorisation from their authors or rightful owners. When this request has not been answered, we assumed that there were no objections to the use of the image. If you feel that this interpretation is unreasonable, please let us know.



**1. Introduction: why these sheets?**

**The reclamation of construction materials is a practice that has many environmental, socio-economical and cultural advantages. This is a priority approach in the perspective of a transition of the construction sector towards circular practices.**

Despite these incentives, designer/specifier who wish to use reclaimed construction materials in their projects are generally faced with questions that they struggle to answer:

- What building materials are suitable for reclamation?
- Where can these materials be found?
- What are the performance characteristics of these products and how can they be evaluated?
- How can these materials be integrated into the prescriptive documents, in particular the specifications?

This collection of sheets intends to bring together as much information as is available on common and relatively recent materials to help purchasing advisers overcome these various obstacles. The aim is to encourage the reclamation of construction materials through a better knowledge of the possibilities and practical ways and means.

To do this, we called on various sources: technical documentation, harmonised standards, available documentary resources as well as interviews with professional suppliers of materials and feedback from example projects.

This introductory sheet brings together cross-cutting information that is applicable to all materials. It also details certain systematic choices made in putting together these sheets.



*Panel door specialised dealer*



*Neatly organized reclaimed carpet tiles*



*Sanitary component cleaning tests*



*Reclaimed brick sorting heap*



*Stone reconditioning*



*Reclaimed wood structural beams*



*Reclaimed wood workshop*





## 2. How are the reclamation sheets structured?

**Each sheet is dedicated to a specific reclaimed material. It is arranged into several sections, addressing the main issues raised by reclamation operations.**

### 2.1. Description

This section summarises the main characteristics of the reclaimed materials concerned: how are they produced, where are they commonly found and in what form? How can they be recognised?

It is supplemented by practical information on the most common formats, colours and textures, the composition of materials, etc.

### 2.2. Salvage

This section details the focal points related to careful disassembly for the reuse of the targeted materials: what should you watch out for and what are the necessary steps?

In general, it is recommended to use companies specialising in the dismantling and salvage of materials. These can intervene in the context of a full-fledged mission or as sub-contractors of general contractors engaged in a project.

Regarding the realisation of an inventory of reclaimed materials in an existing building, we refer to the work carried out on this question within the framework of the [FCRBE](#) project <sup>1</sup>.

Regarding the establishment of a market for dismantling for reuse in the context of



Stone cutting section

public procurement, please refer to the [handbook for off-site reuse](#) <sup>2</sup>.

### 2.3. Applications and implementation

The aim here is to describe what are the most common applications of the reclaimed materials covered by the sheet.

This section is supplemented by information specific to the implementation of reclaimed materials:

Salvage by professional operators. The materials put back on sale by professional operators are, for the most part, cleaned, sorted or even slightly adapted. At the end of these operations, they are generally ready for installation. In this sense, their use does not differ from that of a new equivalent material. Readers should therefore refer to the state of the art (or implementation standards) and to the good practices in force.

Specificities of reclamation. In some cases, the fact that it is a reclaimed material can influence certain installation techniques. Specific features such as the presence of mortar remains, the treatment undergone during the first phase of use, certain forms of wear, etc. can influence material laying techniques. Only these focal points are discussed in the sheets.

In general, designers are encouraged to opt for installation techniques that facilitate the integration of reclaimed materials and maximise the value of the material batches. Tolerating dimensional variations or accepting traces of aesthetic wear is often an effective way to limit waste.



Color variety of terra cotta roof tiles

Some reclaimed building materials are suitable for a wide variety of uses while others cover more limited applications. For example, tiles will be suitable both for a floor covering and for a wall cladding while another kind of tile, because of its thickness, will only be suitable as a floor covering. These indications are detailed in the content of the sheets. Obviously, designers always have the possibility of considering more substantial forms of change of use than those covered by the sheets. In this case, it is up to them to establish the appropriate framework for these operations.

### 2.4. Characteristics and fitness for use

See also the detailed chapter on proof of fitness for use below.

The suitability for use depends essentially on the intended use. In order to meet this requirement, the material must achieve a certain level of performance in terms of some of its intrinsic characteristics.



Careful dismantling of marble wall panels



Blue limestone reclamation operation

<sup>1</sup> FCRBE, *A guide for identifying the reuse potential of construction products*, 2020.

<sup>2</sup> Rotor (S. SEYS, L. BILLIET). *Vade-mecum pour le réemploi hors-site. Comment extraire les matériaux réutilisables de bâtiments publics*, Brussels, 2015.



In all cases, it is the responsibility of the designers/specifiers to ensure that the materials chosen actually meet the requirements arising from this use. In other words, if a regulation imposes a level of performance on a product or material, the designer/specifier or contractor must ensure that it complies with it. In the absence of specific regulations, they will freely choose their product or material on the basis of the adequacy of the level of performance for the intended use.

The way of establishing and measuring the performance of materials may be approached differently when working with reclaimed materials. In contrast to mass-produced new materials, whose technical characteristics are measured and declared by the producer when they are placed on the market, reclaimed materials are not always the subject of such documentation. Other approaches are then necessary to measure and establish their performances.

Designers/specifiers will find in each sheet a list of characteristics that they are likely to need depending on the intended use. To determine these characteristics, we use the corresponding headings in the European technical standards (or product standards)<sup>3</sup> as a basis. Although these standards do not generally include the case of reuse in their purpose, the specific considerations to the intended uses are enlightening here. We have supplemented this information with the available information on reclaimed materials.

However, some performances cannot generally be established. For these, specific measures are to be provided for. Finally, it should be noted that certain materials are not covered by any technical standards (e.g.



Reused glue lam beams

'steenschotten' or scaffolding panels, which are not originally construction products).

## 2.5. Reclamation indicators

This section gives indications on three aspects:

1. **Availability of materials from professional suppliers.** Most of the materials described in these sheets are available from specialist suppliers. Their availability depends on the quantities required. In each sheet, we indicate an order of magnitude of the quantities currently available.
2. **Indicative price.** This reflects the prices found on the reclamation market (specialist resellers, marketplaces, etc.). These indications are however likely to vary according to the geographical area, the heritage character of the materials and their quality.
3. **Environmental impact.** Reusing building materials is generally beneficial from an environmental point of view. This makes it possible to extend the life of existing materials and thus avoid the environmental impacts caused by the production of new elements.

Concerning point 3, we are limiting ourselves here to an assessment based on the potential to mitigate the global warming by focusing on avoided greenhouse gas emissions (kg CO<sub>2</sub> equivalent). Other environmental impacts could also be considered such as the emission of fine particles, toxicity, eutrophication of water, depletion of resources, etc.

We rely on data relating to the impacts of production of new equivalent materials as established in environmental product declaration sheets (database of EPDs and alike formats in the different countries). We count the emissions relating to the production phase (A1-A3), which gives a general idea of the environmental 'carbon gain' linked to strategies for the reclamation of these materials.

This principle is therefore based on a logic consisting in estimating avoided impacts – that is to say, impacts that did not take place thanks to a specific action (in this case,

reusing an existing material rather than making a new one).

Such logic is applied in different contexts. We find it for example:

→ In certain green building certification and rating systems, in particular the French BBCA label. This considers that the impact on production can, for reclaimed materials, be negligent in the overall calculation of emissions during the building's life cycle.

→ In decision-support tools, in particular the Belgian Totem tool.

→ In the formula proposed by the European Commission to assess the environmental footprint of a product (which takes into account, among other aspects, the impacts avoided thanks to the logic of substituting virgin resources).<sup>4</sup>

It should however be noted that this logic is not equivalent to the steps consisting in establishing a detailed profile of the environmental impact of a product. The approach proposed here is not a substitute for an environmental statement. It is not based on detailed life cycle analyses of the operations necessary for the reclamation of the products studied. In some cases, the reclamation process is far from negligible in terms of environmental impacts.

This approach does not take into account the phases which follow production (transport, installation, maintenance, end of life). The few life cycle analyses that have been carried out on reclaimed materials show that, in most cases, it is not during these phases that the gains linked to reclamation strategies (compared with new equivalents) are the most important.

Likewise, the impact of transport can potentially affect the environmental balance – although, again, this should be compared with the distance travelled by a new equivalent.

Finally, we rely as much as possible on several sources. These sometimes show significant variations.

The information provided in the data sheets should under no circumstances be considered as absolute values. These are orders of magnitude making it possible to help in the decision.

<sup>3</sup> Many European product standards are said to be 'harmonised' when the technical specifications covering the product are common to the Member States. If the product is not covered by a harmonised standard, it is generally covered by a European standard transposed in accordance with provisions specific to each Member State. In this case, significant differences may arise (for example on the test method for determining performance). In these sheets, we have mainly drawn inspiration from Belgian standards. Please note that the standards are constantly evolving and that it is advisable to refer to their latest version.



*Reclaimed wood flooring*

### **Special case of the reuse of wood-based materials (and other organic products)**

Assessing the climate change impact of wood-based building products is quite complex. Beyond the classical parameters used for Life Cycle Assessment, the reasoning here integrates the notion of biogenic carbon. Plants metabolise CO<sub>2</sub> present in the atmosphere through photosynthesis in order to ensure their growth. Trees thus constitute an important carbon reservoir and continue to play this role even when they are cut down and transformed into consumer products. This explains why many LCAs of wood-based products have negative values for the production phase. This negative value refers to the amount of carbon captured and sequestered by the plant (biogenic carbon). However, this reasoning is only valid under two conditions:

1. The wood used must come from sustainably managed forests. A new tree must actually be planted in place of the original to justify this benefit. Forest management must also respect the renewal rate of the resource. However, despite local efforts in responsible forest management, the global trend is towards deforestation and the replacement of forests by urban or agricultural land.
2. Wood-based products should not release the biogenic carbon they contain too quickly. This means that wood-based products should be kept in circulation as long as possible in order to preserve their carbon storage function and to prevent them from releasing

greenhouse gases (in the form of CO<sub>2</sub> and/or methane).

As such, the reuse of wood products plays an important role in maintaining the long-term carbon stock in the built environment. Reuse is a good alternative to incineration and methanisation of wood.

However, the assessment of the overall environmental impact of a reused wooden construction element must also take transport into account. Some batches of reclaimed wood available in North-Western Europe are imported from North America (e.g. for 'barnwood') or South-East Asia. These long journeys have an impact on the overall balance sheet. In some cases, it may be more attractive to use local supply chains that are committed to responsible management than to import reclaimed wood from the other side of the world.

The heritage value of wooden components and the fact that the reclaim market can be considered as a local source of wood that is not available locally (e.g. azobe wood from naval applications) should also be highlighted. The latter elements are difficult to quantify and go somewhat beyond the question of carbon balance.

To sum up, it can be considered that in the majority of cases, the reuse of wood elements is a strategy that extends the lifetime of existing materials and preserves the biogenic carbon stock represented by wood-based construction elements. It is also a strategy that helps to reduce the current pressure on forests.

<sup>4</sup> Commission Recommendation of 9 April 2013 on the use of common methods to measure and communicate the life cycle environmental performance of products and organisations (2013/179/EU)



### 3. Demonstrate the fitness for the use of reclaimed materials

Fitness for use refers to the ability of a building material or product to meet the requirements of a given use. These requirements can be of two types<sup>5</sup>:

1. **Regulatory.** These are non-negotiable requirements set by the legislator (e.g. basic requirements at European level, town planning prescriptions at regional level, etc.). They relate to principles such as the safety and health of persons, the stability of structures, fire resistance, limitation of the emission of toxic substance, accessibility for people with reduced mobility, thermal and acoustic insulation, durability, etc. Some of these requirements are expressed by referencing technical standards (e.g. Eurocodes).
1. **Contractual.** These are requirements set by the designer/specifier in the context of a specific project. These may be requirements on dimensions, appearance, colour of materials, etc. It is common for designers/specifiers to refer to technical standards to express these requirements.

The regulatory requirements related to uses are set by the legislative and normative frameworks specific to each Member State (national provisions) as well as by the rules of practice of the construction sector. These usage requirements are the same for reclaimed materials as for new materials. In both cases, designers must be careful *to choose materials whose characteristics meet the specific requirements of a given use*. Knowing all the regulatory provisions remains the responsibility of each designer/specifier and/or project owner.



Refurbished radiator valves

The technical documentation (Declaration of Performance, European Technical Assessment, CE marking, etc.) attached to new products makes it fairly easy to check their fitness for use<sup>6</sup>. The same is not always the case for reclaimed materials.

For them, it is a question of having information on:

→ the original characteristics and performances.

→ any alterations that the material may have undergone during its initial use: wear, gradual deposits of material, physical and chemical transformations, etc.

Depending on their nature and degree, these alterations are liable to affect the performance of the material and reduce the possible applications. In some cases, they can completely jeopardise their reuse.

It would be wrong to consider reclaimed materials as being of inferior quality compared to new equivalents. In some cases, on the contrary, they have quite interesting technical characteristics.

On the other hand, they generally do not have a technical sheet or a performance declaration establishing precisely all their characteristics and performances.

How, then, can their fitness for use be ensured? Several courses of action are possible, depending on the nature of the materials and the requirements to be met. These courses are obviously complementary. The exact procedure will depend on the specificities of each project and the requirements set by insurers and technical inspection services.



Counted reclaimed carpet tiles

### 3.1. Guarantees provided by professional suppliers

Professional sellers of reclaimed materials are an essential link in the chain of operations leading to the reuse of a material. Not only do they take care of the storage and marketing of materials, but they also carry out a series of operations on the materials they salvage: cleaning, sorting, material description, etc.

Salespeople are committed to what they advertise. Most suppliers can thereby guarantee aspects such as the uniformity of a batch from the point of view of material composition or dimensions, the quality of the cleaning performed or the completeness of the batches.

Some go further and offer trade guarantees on certain characteristics of the products sold. For example, certain suppliers of cast iron radiators carry out pressure tests and thereby guarantee the water tightness of refurbished radiators. Suppliers of salvaged steel profiles carry out tests so that they can describe the strength of the elements. Resellers of raised access floor tiles declare performance certified by approved organizations. Brick suppliers are able to declare the compressive strength and porosity of some common types of brick. Sellers of pavers draw up detailed technical data sheets for their products.

It is rare, however, for suppliers to give precise details of all the characteristics of all their materials which they sell. The reason is that they often work with rather disparate batches and in much smaller quantities than in the industrial production of new materials. In this context, it is not tenable to carry out systematic tests.

<sup>5</sup> Florence Poncelet, Morgane Deweerdt, Jeroen Vrijder, 'Réemploi des matériaux: comment justifier leurs performances techniques?' in CSTC Contact, 2020/1, p. 23-26.

<sup>6</sup> Since the introduction of the Construction Product Regulation (CPR) and the harmonisation of product standards, the technical specifications for many construction products are no longer transposed and adapted by each Member State. The essential characteristics of the products covered by a harmonised standard and the way to determine their performances are common for each European country.





### 3.2. Thorough examination

For some characteristics, simple measures can be performed by dealers, contractors or stock takers. For example, establishing dimensions, shades, colours, thickness, mass, etc.

Many common alterations (minor or major) can also be detected visually: presence of deposits, efflorescence, signs of wear, chips, scratches, development of fungi, cracks, discolourations, etc. However, some alterations remain invisible to the naked eye (micro-cracks, metal fatigue, etc.).

Other types of summary checks may be performed when a visual examination is not sufficient. For example, roofers are accustomed to knocking the tiles together to detect the presence of internal cracks through the sound they produce.

Finally, some technical characteristics can be correlated from data that are relatively easy to measure. Thus, the modulus of elasticity of a steel element can be deduced from the hardness of the steel. Such approaches can be of interest when the tests in question prove to be simpler and cheaper to perform.

### 3.3. Original use

This is an approach that works particularly well when it is possible to see the batches before they are taken apart. It is then a question of collecting all the useful information on the material: has it been correctly implemented, in what context, to what stresses has it been subjected, has it been correctly maintained, what were the original climatic or hygrometric conditions, etc.?

All of this information can be useful in carrying out a fitness-for-use assessment. Carrying out an inventory of the potential for reuse (or *diagnostic resources*) is a good opportunity to collect this data.

This work can be accompanied by documentary research in the *as-built* sheets, the original technical sheets, the maintenance and upkeep plans, the historical archives (specialized press articles, photo reports, etc.).

### 3.4. Tests

Certain material characteristics cannot be established with sufficient certainty and precision by the three methods described above. In this case, it will be necessary for approved bodies to carry out laboratory tests.

The cost of these tests varies depending on the measures to be taken and the sampling required.

In the case of a batch of material supplied by a professional seller, it is recommended to carry out the test in the presence of both the buyer and the seller. Where possible, samples are taken from different places in order to obtain an average sample size. In most cases, these certified testing organisations will assist in setting the appropriate sampling method.



Quality controlled bricks



Backside of a reclaimed cement based floor tile

### 3.5. Precautions against hazardous substances

Some reclaimed construction products may be contaminated with hazardous substances. For example, wood impregnation products containing arsenic or PCP (pentachlorophenol), lead- or cadmium-based paints, materials made of asbestos, floors laid with tar adhesive, etc.

Since the end of the 20th century, new regulations have set a stricter framework that restricts or bans the use of many toxic substances. However, existing buildings still contain materials that predate the application of these regulations and may therefore present a toxicity risk. The forms of contamination are variable and multiple. We will, as best as possible, outline the most frequent cases in each of the sheets.

Here are some general principles to flag this question:

→ **Compliance with current legislation:** for example, materials made of asbestos must be inventoried prior to demolition/renovation and are obligatorily considered as hazardous waste when they are evacuated. Dismantling is generally carried out by approved companies, according to a binding work protocol. Their re-use is therefore prohibited.

→ **Risk analysis:** in case of doubt, it is advisable to rely on an expert assessment to determine the level of risk and to deduce the measures to be taken. This assessment is generally based on laboratory tests carried out on samples.

→ **Decontamination:** Certain forms of contamination can be remedied to extend the life of a material. This is particularly the case for forms of surface contamination, such as the application of heavy metal paints or tar adhesives. Stripping these layers can result in a healthy material that is ready for reuse. These reconditioning operations must, however, be carried out in accordance with the environmental and health regulations in force. Many professionals in the sector are able to carry out such operations.



→ **Restriction of use:** certain substances may present a risk when associated with certain uses (indoors, in direct contact with the skin, etc.) but do not present a risk when associated with other applications (outdoors, out of reach of users, etc.). It is therefore advisable to limit the use of the materials concerned to applications in which they do not present a risk. For example, a batch of PCP (pentachlorophenol) emitting boards may be suitable for outdoor cladding applications, provided that the risk of contact with skin and food is limited.

→ **Protection of workers:** the removal of risk elements requires that adequate provisions be made to limit the risk of worker exposure.

→ **Implementation:** as a general rule, it is recommended to avoid contaminating the recovered material with substances potentially harmful to the environment or human health. This criterion also facilitates subsequent reuse. For example: re-painting cast iron radiators using eco-friendly paints with low VOC (Volatile Organic Compounds) content is preferable to polyurethane-based paints.

### 3.6. Alternative design strategies

*Last but not least*, if there is no information or a doubt about the performance of the material, it is also possible to adapt design strategies that give pride of place to “cascading” principles : one logic that has proved its worth is to consider reusing a material for less demanding uses than the original ones.

Any doubts about the porosity of a batch of slate? Perhaps these can be reused in a part of the building that is not exposed to the elements. No way of measuring all the performance of a steel beam? Maybe it can still be used for non-structural purposes for interior designs. A batch of particularly chipped tiles? Maybe these can still be used for spaces well-suited to these imperfections. Any doubt on the fire-resistance of a door? Why not reserve it for spaces that are not concerned by this requirement?

We can also cite the principles of redundancy and oversizing.

In general, establishing a rapid link with the engineering and control offices helps to control costs and assess the ecological and economic advantage of the operation.



*Reclaimed fire retardant door*



*Sanitary components cleaning station*



*Residue on the side of a reclaimed marble tile*



#### *Read more!*

*Technical framework for reused materials: How to justify the technical performance of reclaimed materials? Le Bâti Bruxellois : Source de nouveaux Matériaux (BBSM). May 2021. (Document in French)*

<https://www.bbsm.brussels/wp-content/uploads/2021/06/annexe-16-WP6-cadre-technique-des-matériaux-de-reemploi.pdf>





#### 4. Advice

In principle, the information mentioned in the sheets (possibly supplemented by specific procedures) should allow designers/specifiers to formulate reuse operations in their specifications.

Here are some general considerations in this regard, considering several scenarios.

Please note, these suggestions are not standard clauses that can be copied as in a specification. It is important that each designer/specifier adapts them to the terms of his project.



Careful dismantling of tile floor



Repackaged reclaimed ceramic tiles



Reclaimed timber formwork steenschotten panels

#### 4.1. Specify the removal of a batch of material for its reuse

Whether for reuse on-site or via professional take-back channels, it is a matter of specifying *careful dismantling of the affected batches*.

Depending on site organisation, this will take place during demolitions or during construction. In all cases, it is important to specify the objective of the operation (i.e. the future reuse of the elements).

If this has not been done beforehand, a dismantling test can be requested from the contractor in order to ensure the feasibility of the operation and to know the loss rate.

##### Example:

'Batch [XYZ] will be carefully dismantled for future reuse.'

The service provider will ensure that the batch is stored in conditions which make it possible to preserve its qualities [possibly specify the conditions: protected from frost / bad weather / dry conditions / protected from dust...].

The batch will be packaged [specify the applicable packaging requirements: on pallet / in boxes / strapped in packages of X pieces / in bulk...].

The batch will be sorted according to [specify the applicable criteria: shapes / colours / dimensions / quality...].'

At this stage, it is recommended to work in Presumed Quantities.

##### Example:

'Only the surface areas actually salvaged will be paid by the Client'



Wall tiles and sinks before dismantling

#### 4.2. Specify a removal and reuse operation on-site

In an on-site reuse scenario, it is important to clearly define the distribution of tasks.

##### Example of distribution:

*Dismantling + Storage = responsibility of the demolition company.*

*Cleaning + relaying = responsibility of the construction company.*

It is advisable to leave the possibility for general contractors to call on specialised service providers for operations linked to reclamation (i.e. dismantling companies).

In certain cases, it will be necessary to provide for the possibility that these operations are carried out off-site if the site conditions do not allow working correctly or storing the materials in good conditions.

It is also useful to refer to the removal station in the clause provided for installation.

##### Example:

'The batch [XYZ] to be installed comes from a careful dismantling operation with a view to this reuse carried out in a previous contract/item [specify which].'

The batch has the following characteristics [specify format, colours, any associated elements...].

The salvaged [XYZ] items are in good condition. The contractor can inspect the batches/samples on-site.

The elements must be [specify expectations: cleaned/stripped/sandblasted/coated/treated against certain stresses/cut/made to certain dimensions...] before being installed.

Operations [specify which] are/are not included in this job.

A surplus of [specify percentage or absolute quantity] is expected for future repairs.

Presumed quantity (PQ) in [specify: m<sup>2</sup>, pieces, m<sup>3</sup>, tonne...] – net surface area – installation price only (excluding material purchase, already on-site).'



Finally, it may be counter-productive to oblige a contractor to reuse a batch dismantled on the same site, in particular if the dismantling has not been studied beforehand. It is then up to the contractor to assume the risks if the dismantling proves to be disappointing.

To overcome this scenario, it is useful to separate the two actions:

→ Subject the contractor to a *duty to take reasonable* care in recovering a maximum of such a batch with a view to its reuse (either on-site, or via professional or other reuse channels).

→ Indicate to the contractor that the materials to be re-implemented must come from reclamation.

In this case, if conditions allow, the contractor will be encouraged to reuse on-site. However, it will not be blocked if conditions do not allow it; the dismantled materials will always have the possibility of finding a new use elsewhere, while reclamation channels will be properly activated for the supply of new elements.



Green reclaimed ceramic wall tile

#### 4.3. Specify the implementation of a reclaimed batch

In this case, the batch comes from an external source. The company can obtain supplies from a professional dealer or even suggest materials from another work in progress.

##### Example:

*'This job concerns the installation of a batch of reclaimed [XYZ]. These elements are to be supplied by the contractor via a professional supplier/via another demolition site/other [specify]. The contractor will indicate to the client the origin of the material in order to ensure that it is not an imitation reclamation.'*

The designer/specifier then describes his requirements:

- Description of the material: composition, variety, etc.
- Dimensions and dimensional tolerance.
- Aspects: colour, texture, shade, etc.
- Expected degree of cleaning.
- Tolerance to cosmetic imperfections.
- Forms of (un)tolerated alteration
- Other required performance.

##### Example for reclaimed wall tiles:

*'The set of reused ceramic wall tiles contains the following elements: plain tiles/frieze elements/edge elements. The tiles are in a format of  $X \times X \times X$  cm, with a dimensional tolerance of  $\pm XX$  mm. They are plain/decorative... in appearance and uniform in colour [to be specified] or of a shade [to be specified]. Cracked glaze is/is not accepted [possibly specify the reservations: only if the cracked glaze is original]. The delivered batch is uniform: it only contains ceramic wall tiles. The tiles are delivered in good condition and completely cleaned of mortar residue on the front side/on the edges/on the front side and on the edges. Chips on the edges do not exceed  $XX \text{ mm}^2$  per tile [provide a drawing if necessary].*

*Surface preparation (plaster and repairs), grouting and finishing are included in this item.*

*Presumed quantity (PQ) in  $\text{m}^2$  - net area.'*



Ceramic wall tiles

The designer/specifier can draw the attention of the person carrying out the work to the existence of professional sales channels of reclaimed construction materials, by providing them with the reference to sectoral directories such as [opalis.eu](http://opalis.eu) or [salvoweb.com](http://salvoweb.com).

The order for removal/installation must be aligned with the administrative clauses of the specifications. If necessary, these must be adapted to set guidelines for reuse operations.

Do not forget to indicate the jobs involved in the reuse in the quantity survey and on the executive plans.



Blue reclaimed ceramic wall tile edge





# LANDSCAPING AND PAVING



- Natural stone setts
- Natural stone kerb
- Clay pavers (Clinker)
- Steenchotten formwork panel
- Ship timber



**Disclaimer**

This sheet is intended for designers, specifiers and other members of construction project teams wishing to reuse this building material or product. It is part of a collection of sheets aimed at bringing together the available information to date that is likely to facilitate the reuse of building materials and products.

This sheet has been produced by Rotor vzw/asbl within the framework of the Interreg FCRBE project - Facilitating the Circulation of Reclaimed Building Elements, supported by the entire project partnership. Sources of information include the experience of reclamation dealers and involved project partners, lessons learned from exemplary projects, available technical documentation, etc.

The sheets have been produced between 2019 and 2021. As the reclamation sector is evolving, some information, notably regarding pricing and availability, may change over the time. When the text refers to European standards, it is up to the project team to refer, if necessary, to their national implementations and local specificities.

It is important to note that the information presented here is not exhaustive or intended to replace the expertise of professionals. Specific questions are always project related and should be treated as such.

The complete collection of sheets (including the introductory sheet) is freely available from different reference websites (a.o. [opalis.eu](http://opalis.eu), [nweurope.eu/fcrbe](http://nweurope.eu/fcrbe), [futureuse.co.uk](http://futureuse.co.uk)).

Non-exhaustive directories of dealers in reclaimed building materials are available on [www.opalis.eu](http://www.opalis.eu) and [www.salvoweb.com](http://www.salvoweb.com).

---

Interreg FCRBE partnership: Bellastock (FR), the Belgian Building Research Institute / BBRI (BE), Brussels Environment (BE), the Scientific and Technical Center of Building / CSTB (FR), Confederation of Construction (BE), Rotor (BE), Salvo (UK) and University of Brighton (UK).

The information contained in this document does not necessarily reflect the position of all the FCRBE project partners nor that of the funding authorities.

Unless explicitly stated otherwise, the content of these sheets is credited in the Creative Commons Attribution NonCommercial – Share Alike format (CCBY-NC-SA).



Unless explicitly stated, the images used in this document belong to © Rotor vzw/asbl or © Opalis. Any other image has been the subject of a systematic request for authorisation from their authors or rightful owners. When this request has not been answered, we assumed that there were no objections to the use of the image. If you feel that this interpretation is unreasonable, please let us know.





**Material description**

Used and reused throughout the ages, natural stones setts have long been the solution of choice for planning roads and public spaces. They were, however, ousted throughout the 20th century by road surfaces such as concrete and by-products from the petroleum industry. In recent decades, stone setts have received renewed interest from some planners, particularly in contexts involving a heritage approach.

Emblematic of a form of circular economy before its time (the reclamation of paving stones is widely documented in history), stone setts are today caught up in a somewhat paradoxical situation. Europe imports large quantities of new stone setts (mainly from Asia) while it exports a significant amount of its stock worldwide.

Despite these underlying trends, the reclamation of setts remains a relatively well established practice in public works and the construction industry. There are many well established companies specialising in their recovery and resale. In addition to sorting, cleaning and packaging old setts, some companies are also exploring new ways to meet the requirements now expected by developers, in particular by developing techniques for cutting stone setts or by imagining new applications.

This sheet mainly focuses on the use of natural stone setts for exterior (surrounding area) and interior flooring, in contexts other than public roads (the latter being the subject of specific specifications).

It should also be noted that the term "stone setts" actually covers a huge variety of parts that are ultimately very different. While setts can be defined in a very general way as hard, parallelepipedal elements used through juxtaposition to compose a floor covering, it is necessary to take into account the possibility of almost infinite variations.

→ **Formats.** There is a wide variety of setts sizes, depending on the era, region and use, some of which are more common (Figure 1). Beyond these large groups of formats, there are a multitude of specific names, often closely linked to a region, a format, a type of rock or a particular treatment. To name but a few: "pavés du Roy" (French sandstone setts measuring 23 × 23 × 23 cm), "pavés Napoleon" (French sandstone setts measuring 20 ×

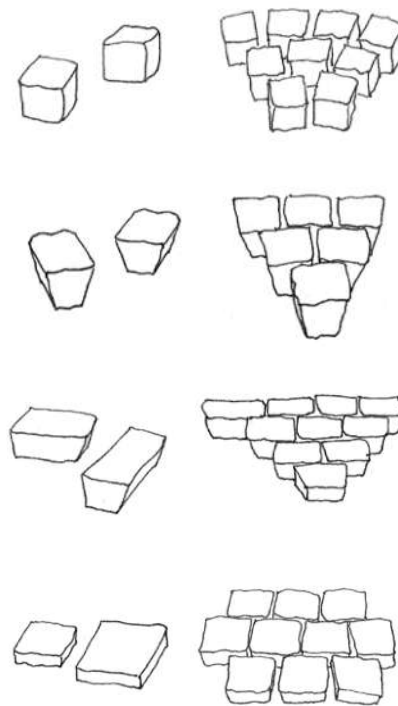

**mosaic setts** (cubic or almost cubic shape): 7 to 12 cm per side of the head surface and thickness. In practice, batches of mosaic stone setts are rarely sorted and may also contain trapezoidal elements resulting from fan-shaped fittings.

**square setts** (cubic shape): 13 × 13cm, 15 × 15cm, 17 × 17cm, 20 × 20cm, for thicknesses 11-20cm. They often have the particularity of being thin at their base (max. 1.5 cm shrinkage on each of the edges of the base).

**oblong setts** (parallelepipedal shape): 9 × 14 cm, 11 × 17 cm, 14 × 20 cm, for thicknesses between 10 and 15cm. Some models are also narrow based.

**flagstones** (more flattened format): : 12 × 12 cm, 14 × 14 cm, 16 × 16 cm, for thicknesses between 5 and 10 cm. These setts are generally used for pavements. Some models are also narrow based.

Figure 1. Main families of natural stone setts of common sizes and proportions

20 × 20 cm), "Boerenkasseien" in Belgium and the Netherlands, Yorkstone setts in UK, Sampietrini in Italy, etc.

→ **Geological nature.** Many types of stones have been used for cutting producing setts. Beyond the large petrographic families, the origin of the stones also have great diversity (see on the right).

→ **Colours.** The diversity of the rocks means that there is a wide range of colours. The same rock can also vary greatly in colour. A specific vocabulary makes it possible to designate the encrustations of the stone (veins, grains, strata, holes, etc.).

→ **Texture and finish.** The more or less pronounced texture of the setts depends on the stone used and the production techniques (cleavage, dressing, sawing). The visible face may have a domed, flat or irregular shape if it does not undergo any treatment and is smooth and flat when the block is sawn. The performance associated with the paving stone's finish, such as slip resistance and wear resistance, determine its use (pavement, suitable for disabled people, etc.). The stresses to which setts are subjected during use can also result in a gradual softening and polishing of the visible face.

**Magmatic (or igneous) rocks**

Granite  
Basalt  
Porphyry

**Metamorphic rocks**

Gneiss  
Marbles  
Quartzite

**Sedimentary rocks**

Sandstone  
Limestones  
Sandstone limestones



**Material reclamation**

**Natural stone setts are mainly found in exterior applications such as roads, squares, terraces, walkways, or even retaining walls and low walls. As long as they are not sealed with cement mortars, their recovery is easy. For reclamation on the same site, it is possible to carry out on-site sorting, cleaning and possibly sawing operations, as far as conditions allow. Most of the time, the dismantled setts are sent to a specialised company which can also take care of delivering batches of stone setts ready for installation. These professionals are able to ensure the smooth running of the following operations:**

→ *Dismantling tests.* Dismantling tests make it possible to verify the feasibility and profitability of the removal. The type of bedding, the characteristics of the joints and the nature of the stone setts are the main factors which affect the ease of dismantling.

→ *Removal.* During disassembly, the main point of attention is to make sure to maintain a certain uniformity of the batches. There is little risk of material deterioration. Disassembly is carried out manually for lines of specific formats (start of line, backstop, etc.) and mechanically for uniform surfaces. The use of a hydraulic shovel equipped with a lattice tray (or screen) can remove the worst residues of sand, earth, moss and gravel.

→ *Cleaning and sorting.* Batches of dismantled setts are generally handled on conveyor belts on which they undergo operations such as:

- water cleaning;
- manual sorting and cleaning to remove mortar and/or asphalt remains;
- specific sorting (sifting machine plus semi-automated or manual sorting) in order to separate the setts according to the type of stone, the format and the colour.

During this process, setts that are split or have visible damage are rejected. The rate of loss strongly depends on the type of rock and the original use conditions. It can go up to 20% for sandstone flagstones (generally, sedimentary rocks, which have a natural cleavage plane, are more sensitive to cracks and breaks).



*Sandstone setts and traditional laying on a sand bed: recovery is generally easy*



*Setts with cement joints: recovery promises to be difficult*



*Use of a riddle bucket*



*Example of a poorly laid sandstone sett. The cleavage plane must be parallel to the direction of laying. In this case, the sett probably underwent stresses which caused its cleavage. This sett will be discarded during sorting related to reclamation.*

**Did you know?**

Some towns have their own stock of road materials. In Paris, for example, it is mandatory to reuse suitable stone setts on site or to divert them to a centralized stock, which contractors must also use for new developments. This platform, set up more than 20 years ago, ensures, among other things, the collection, sorting, cleaning and storage operations of Parisian stone setts. In addition to minimizing the costs associated with the purchase of new materials, it would prevent the dumping of 7,000 to 8,000 tonnes of granite per year (setts + kerbs), corresponding to 600 tonnes of not emitted CO<sub>2</sub>. (Source : Paris City Hall Maintenance and Supply Centre (CMA, ADEME).



*Specific sorting station*





→ **Treatments.** While some stone setts can be reused as they are after a rough cleaning, others go through additional operations that affect their characteristics:

• **Sawing in 2 equal parts (Figure 2).**

Provides two setts of equal thickness with a new smooth head surface. These elements no longer meet the same level of performance as the original element. In the case of narrow stone setts (that is to say, the base of which is narrower than the visible face), cutting gives rise to elements of different dimensions. In addition, the upper part of the sett is placed in a direction that no longer respects the narrowness. Some operators do not sort between the two items. This can have an impact on some types of installation so it should be taken into account.

• **Sawing of the upper part of the sett (Figure 3).** Results in a thick sett whose new visible face is very smooth and with similar mechanical performance to that of the original product (also called rectified sett). It also results in a thinner by-product (1 to 4 cm) called a “cap”, “crown” or “head-shaped stone”. The latter is not always valued locally, but large quantities are nevertheless exported abroad. This operation is also used to get rid of asphalt remains that are difficult to remove by cleaning.

• **Cleavage.** Splitting a sett into two equal parts. Using a splitter can produce a more irregular head surface than by sawing. Be careful in case of narrower base.

Sawing of hard stones (such as granites and porphyries) is rarer. For sedimentary rocks, the sawn face must necessarily be parallel to the stratification plane.

→ **Storage and packaging:** unsorted stone setts are generally stored in bulk in outdoor silos. Sorted and cleaned setts are stored in the same way. They can also be packaged on pallets, in wooden crates or big bags to avoid mixing. Mosaic setts are usually delivered in bulk.

Ready-to-install soon setts are clearly identified and labelled in uniform batches. They are sold by the m<sup>2</sup> or by the ton. Most suppliers are able to provide a technical sheet showing the characteristics of the stone setts (type of rock, nominal dimensions and tolerances, finish, intended applications) as well as their origin. More exceptionally, some suppliers can more precisely characterise the performance of a batch of stone setts

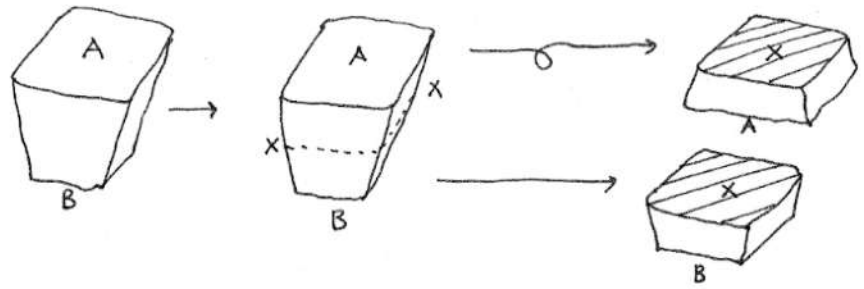

Figure 2. Sawing in 2 equal parts

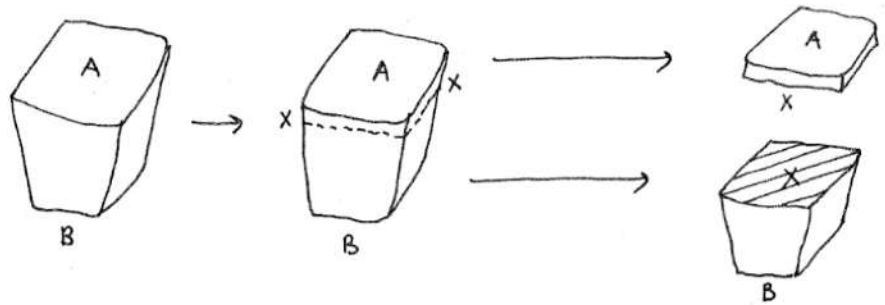

Figure 3. Sawing of the upper part of the stone sett

depending on a test report carried out on a reference sample (petrographic, chemical, physical and mechanical characteristics).

It is advisable to involve specialised professionals to ensure the smooth running of these operations.



Sawing of the upper part of the stone sett



Storage of stone setts



Storage of stone setts



Storage on “palette-box”



Storage of paving stones in big bags



**Applications and laying**

**For three decades, the evolution of the urban environment and the awareness of the aesthetic and heritage interest of stone setts have enhanced their use and that of natural stones in general. The recent design of works in reclaimed natural stone setts generally incorporates a multidimensional approach: historical, architectural, functional, sociological and environmental.**

Reclaimed setts are mainly used as modular elements for covering exterior or interior floors, for applications subject to moderate stress (pedestrians, squares, alleys, etc.) or more intense (roads suitable for motor vehicles). They are also suitable for masonry constructions in low walls and retaining walls. The by-products resulting from sawing ("caps" 1 to 2 cm thick) can be used as a floor covering for uses subject to low stresses, as wall and façade cladding or as exterior floor covering element.

The choice of a type of sett depends on the stresses specific to the intended use: expected traffic, climatic conditions, noise level, permeability of the pavement, town planning rules, etc. The pavement as such is not everything. The installation technique envisaged also contributes greatly to meeting

the expected requirements - in particular, and not exclusively, according to the type of foundation and the laying layer, the type of jointing, the type of equipment, the nature of the blocking elements, etc. Likewise, the quality of the installation can make all the difference between a floor covering that meets expectations and a covering that does not (for example, in terms of flatness). Finally, the design of paving stone structures requires taking into account the planned maintenance. For example, it is preferable not to use gravel joints in a market place where a brush/sweeper passes regularly.

In this regard, the points of attention related to the installation of reclaimed stone setts do not differ from those related to new ones. It is up to the designers/specifiers to rely on the regulations, the rules of practice and the technical standards in force in this field (in particular the European standard for exterior paving EN 1342). It should be noted that some local reference guides on the installation of stone setts already include the case of reclaimed setts (for example: the Qualiroute standard developed in the Walloon Region, Belgium).

The table below (table 1) shows the main requirements applicable to the installation of road stone setts for information purposes.



*Think reversible!*

*Certain laying methods complicate or even prevent the recovery of stone setts. This is particularly the case with rigid laying, involving mortars and hydraulic binders. In this sense, as soon as possible and with comparable performance, it is preferable to favour a flexible installation (flexible base, sand bed and sand joints, stabilised sand or from a bituminous emulsion). Carried out according to the rules of practice, this installation method is very resistant to stress, is easily repaired and does not cause damage such as lifting or cracking.*

Table 1 : Main requirements for the installation of stone setts

Recommended use	Compressive strength (MPa)	Minimum thickness (cm)	Stone setting	Installation type
decoration	no requirement	no requirement	All	Flexible or rigid
pedestrian use only	> 50	6	All	Flexible or rigid
pedestrian and cycling areas	> 85	8	All	Flexible or rigid
occasional access for light vehicles, garage entrances	> 100	8	All	Flexible or rigid
pedestrian traffic area, market places, occasional circulation of delivery/rescue vehicles	> 100	10	Not in panel	Rigid
pedestrian traffic area frequently used by heavy trucks	> 100	10	Not in panel	Flexible or rigid
roads and streets	> 100	12	Not in panel	Rigid



Sawing in 2 equal parts



Installation of sawn setts



Installation of sawn / rough pavers





The following characteristics can be described and specified when drafting the technical requirements related to the delivery of a batch of reclaimed stone setts:

→ **Batch composition.** The batch consists of reclaimed stone setts of the same type, same geological nature or even from the same original use. It is advisable to define one batch as a surface to be paved, with the same application and a maximum of 500 m<sup>2</sup>. However, mixed stone setts batches may be suitable for less demanding applications.

→ **Format.** Depending on the installation, the stone setts must have a greater or lesser dimensional stability (same dimensions and same narrowness). Note: "mosaic" type installations accommodate greater variability in this regard.

→ **Colour.** By nature, variability in colour and appearance is specific to natural stones.

→ **Condition.** The batch must not contain items with cracks or major damage. Depending on the requirements, specify that the setts must be free of mortar and asphalt remains.

→ **Shape and finish.** According to the required needs, specify the appearance of the visible face (sawn, cleaved, convex, irregular, flat, etc.) and ask that it be identical for the entire batch.

→ **Quantity.** Some suppliers may include surplus when the product is delivered if they are not able to guarantee the absolute uniformity of the characteristics mentioned above. This surplus can also be applied in the case of an on-site salvage scenario. It is generally advisable to provide a reserve stock of stone setts in order to carry out subsequent repairs.

Most professional suppliers are able to ensure that delivered batches meet these requirements. A control test procedure based on a contractual sample and sampling upon receipt can be set up.

Most of the reclaimed building materials are sold as is. The conditions of sale may however contain special guarantees specific to the material. Some suppliers are able to indicate the origin of the material and/or provide documentation on the product purchased (for more information, see the introductory sheet).

**Design tip!**

*To increase the chances of meeting the offer available on the reclamation market, the designer/specifier can choose to split large surfaces into smaller quantity batches (for example, by providing different assemblies and patterns on the surface to be paved).*



Raeren town square (BE) © Carrière de la Hazotte



Project "Charles Malis", Molenbeek (BE) (Archi : Mamout + Willock + LD2) © Studio Fiftyfifty



**Characteristics and fitness for use**

The harmonised European standard EN 1342 establishes the relevant characteristics (depending on the context) in order to determine the fitness for use of natural stone setts intended for exterior paving. Although detailed for new materials from the extraction and processing of natural stones, these characteristics may prove useful in considering the specific case of reclaimed setts (table 2).

Table 2: Characteristics relevant for determining the fitness for use of natural stone setts for external paving

Characteristics	Comments
<b>Geological origin and petrographic description</b>	The reclaimed stone setts come from works that may have been made from batches of multiple origins. If it is possible to visually characterize the type of rock present, it is however very rare that we can say with certainty that their geological origin is identical, unless there are records that allow it to be attested (for example: a certificate of origin for recent items or archival documents for older items). This is all the more true for the batches made up of stone setts of various origins.
<b>Geographical origin</b>	As with the geological provenance, information on the original geographic provenance of a batch of reclaimed stone setts is difficult to certify with any certainty. On the other hand, we can deduce certain characteristics if we know where the setts were removed. Thus, stone setts in good condition that have been dismantled in an area subject to strong freeze/thaw cycles are likely to show good frost resistance. Another example: stone setts in good condition coming from a street subjected to intensive traffic by heavy vehicles testify in some way to their good compressive strength. Thus, in the absence of information on the original quarry, it may be useful to have information on the roadway where the setts come from.
<b>Bulk density and porosity</b>	These characteristics are specific to each stone and can easily be found in the technical documentation. If necessary, they can be measured by an identity test as defined by a test standard (EN 1936).  The porosity of a stone (or water absorption) does not directly affect its frost resistance. On the other hand, it influences its degree of resistance to soiling.
<b>Flat dimensions (length, width)</b>	This characteristic can be found out by taking simple measurements. It is closely related to the degree of sorting and cleaning of reclaimed stone setts. It is advisable to define with the supplier the applicable dimensional tolerance, depending on the equipment required and the functionality of the work. For example: flagstones in a straight fit require high dimensional stability (tolerance $\pm 10$ mm).
<b>Thickness</b>	Use and type of stress generally define the minimum thickness required. The thickness tolerance is mainly dependant on the laying method and the thickness of the laying bed. For example, in flexible laying on a sand bed, a tolerance of more than 15 mm thickness is possible if the sand layer is 7 cm thick ( $\pm 1.5$ cm). In rigid or semi-rigid installation, a lower tolerance applies. It is therefore advisable to define this tolerance with the supplier.
<b>Narrowness, flatness and irregularity of the cleaved faces</b>	These characteristics are closely related to the degree of sorting and cleaning of reclaimed setts. A visual or detailed examination of the batch is often sufficient to estimate them.
<b>Compressive strength</b>	This factor mainly determines the capacity of the work to withstand loads (vehicles, heavy goods vehicles). It is recommended to use paving stones with a strength greater than 60 MPa for structures subject to the passage of light vehicles (up to 25 heavy vehicles/day) and >120 MPa if the number of heavy goods vehicles exceeds 150/day. A standard test makes it possible to measure this parameter (EN 1926).
<b>Slip and skid resistance</b>	This feature influences the comfort and safety of users. It mainly depends on the roughness and texture of the surface. This characteristic changes over time under the influence of the surface wear, the presence of dirt, the maintenance conditions, the slope, the density of the joints and the climatic context (rainfall). In general, stone setts with a coarse texture (sandstone) and an irregular finish (not sawn) have sufficient slip resistance. A test standard makes it possible to measure this parameter for stone setts which have been sawn or have irregularities of less than 1 mm (EN 14231). The in-depth assessment of slip resistance is relevant when the work is intended for pedestrians and the skid resistance when the structure is intended for vehicular traffic. Specific finishing treatments (flame treatment, for example) may be applied during use in order to meet the requirements in force.



Characteristics	Comments
<b>Resistance to freezing/thawing (and de-icing salts)</b>	The source and condition of a batch of stone setts can provide a useful guide to determining their resistance to freezing/thawing. Many old paving stones are in fact likely to have withstood, during their first use, more freezing/thawing cycles than what is recommended by the test standard which allows this performance to be evaluated on batches of new stone setts. (standard EN 12371 is indeed based on a test device which amounts to a laboratory simulation of cycles of successive exposure to climatic conditions varying in temperature and humidity). Less resistant setts that have suffered frost damage will probably have been discarded during the sorting steps.
<b>Abrasion and scratch resistance (wear)</b>	This durability characteristic depends on the intensity and type of traffic, the presence of abrasive particles and the maintenance conditions. If there is a test standard which allows this characteristic to be evaluated with precision (EN 14157 - Capon test), it can also be used for reclaimed stone setts, by relying on the way in which they have withstood the demands of their first use. In general, granites, porphyries and basalts are suitable for intense stress and are more resistant to wear than sandstones and limestones.
<b>Dirt resistance</b>	A porosity of less than 4% is generally satisfactory in order to limit the risks of soiling. It is also possible to visually identify the degree of soiling of the reclaimed stone setts by observing the visible face of the unprocessed (sawn) elements. Specific surface treatments can also be recommended to improve this performance.

As an indication, the following table (*table 3*) shows some of the known performances of some types of rock constituting stone setts which are frequently reclaimed. Once again, it is important to point out that each stone has its own characteristics and that two batches of stone setts of the same rock can however have quite different performances.

*Table 3: Characteristics of the most common types of rock constituting stone setts which are frequently reclaimed*

	Bulk density (kg/m <sup>3</sup> )	Compressive strength (MPa)	Porosity	Wear resistance
<b>Sandstone</b>	2000 - 2700	200 - 260	little porous	++
<b>Bluestone (and limestone)</b>	1500 - 2800	60 - 200	little porous	++
<b>Porphyry</b>	2000 - 2800	280	very little porous	+++
<b>Granite</b>	2500 - 3000	100 - 210	very little porous	+++
<b>Basalt</b>	2800 - 3000	320	very little porous	+++



Molenbeek town square (BE)  
© a practice, Atelier Ruimtelijk advies et Marie-Françoise Plissart



Community center Werf 44, Schilde (BE)  
© Conix RDBM Architects





**Availability**

The professional market for reclaimed natural stone setts is quite substantial. Suppliers are able to easily supply large quantities (>1000 m<sup>2</sup>).

**Indicative prices (excl. tax)**

Random sampling of the reclamation market in Western Europe (Belgium, France, Great Britain and the Netherlands) made it possible to extract some indicative prices. These vary depending on the availability of the size and type of stone, as well as the degree of sorting and cleaning requested. A sorted stone sett is often more expensive than an unsorted one, but is easier to place.

- Cost of removal: 10 - 15 €/m<sup>2</sup>. If the quantity is sufficient, disassembly can be taken care of by the operator.
- Supply: depending on size, type of stone, general condition of the batch, etc.
- The sawing operation generally costs between 30 and 60 €/m<sup>2</sup>.

*Did you know?*

*In his memoirs, Baron Haussmann recounts that he tried to convince Napoleon III to choose porphyry setts for the roads of the new Paris. Haussmann is full of praise for them: cleanliness, strength, durability, etc. But Napoleon III is a horseman! And hooves don't like cobblestones, they slip! He wants dolomite everywhere - and so much for the footmen who will have to deal with the mud on rainy days. Haussmann does not drop the subject. He urges his technical teams to think about a rubber horseshoe system, which would be better suited to cobblestones. He'd rather change the hooves of all the horses in Paris than see that damn dolomite. Ultimately, it is all the same for the emperor who will succeed and Paris will not have porphyry! (Memoirs of Baron Haussmann, 1890, Victor-Havard, Paris).*

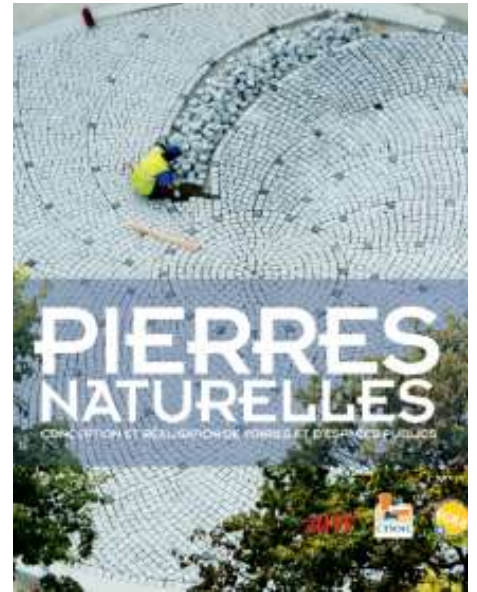

*Pierres naturelles - Conception et réalisation de voiries et d'espaces (2019) (In French), RGRA, 440 p., ISBN : 978-2-913414-52-5*

**Find specialised businesses**

**SALVO** **OPALIS**  
salvoweb.com opalis.eu

[salvoweb.com](http://salvoweb.com) [opalis.eu](http://opalis.eu)



*Pavés de Bruxelles (2015) (in French), AAM Editions, 521 p., ISBN : 978-2-87143-308-8*

Sorted and cleaned reclaimed stone setts	New stone setts
Sandstone 40 - 50 €/m <sup>2</sup>	Belgian sandstone : ~ 90 €/m <sup>2</sup>
Granite : 30 - 40 €/m <sup>2</sup>	Indian sandstone : ~ 30 €/m <sup>2</sup>
Basalt : 30 - 50 €/m <sup>2</sup>	Portuguese granite : ~ 30 €/m <sup>2</sup>
Porphyry : 20 - 30 €/m <sup>2</sup>	Vietnamese basalt : ~ 35 €/m <sup>2</sup>
Porphyry (mix of formats) : 15 - 20 €/m <sup>2</sup>	
Mosaic paving stone : 30 - 40 €/m <sup>2</sup>	

**Embodied carbon (Cradle to gate - production A1-A3)**

	kg CO <sub>2</sub> eq./m <sup>2</sup>	kg CO <sub>2</sub> eq./kg
INIES database (FR)- Generic data *	45.0	-
ICE database (UK)- Granite **	175.0	0.7
ICE database (UK)- Sandstone ***	12.0	0.06

\* Indicative value for a 1 m<sup>2</sup> and 15 cm thick natural stone covering of roads or public spaces for a reference lifespan of 150 years.

\*\* Indicative value for a 1 m<sup>2</sup> covering in granite (thickness = 10 cm, density = 2500 kg/m<sup>3</sup>)

\*\*\* Indicative value for a 1 m<sup>2</sup> covering in Sandstone (thickness = 10 cm, density = 2500 kg/m<sup>3</sup>)

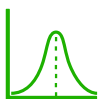

According to the sources, reusing 100 m<sup>2</sup> of reclaimed natural stone setts prevents the production of ~ 1,200 to ~ 17,500 kg of CO<sub>2</sub> equivalent related to the manufacture of new stone setts (production phase only). According to sources, this corresponds to the emissions of a trip of ~ 7,200 to ~ 105,000 km in a small diesel car.

**Disclaimer**

This sheet is intended for designers, specifiers and other members of construction project teams wishing to reuse this building material or product. It is part of a collection of sheets aimed at bringing together the available information to date that is likely to facilitate the reuse of building materials and products.

This sheet has been produced by Rotor vzw/asbl within the framework of the Interreg FCRBE project - Facilitating the Circulation of Reclaimed Building Elements, supported by the entire project partnership. Sources of information include the experience of reclamation dealers and involved project partners, lessons learned from exemplary projects, available technical documentation, etc.

The sheets have been produced between 2019 and 2021. As the reclamation sector is evolving, some information, notably regarding pricing and availability, may change over the time. When the text refers to European standards, it is up to the project team to refer, if necessary, to their national implementations and local specificities.

It is important to note that the information presented here is not exhaustive or intended to replace the expertise of professionals. Specific questions are always project related and should be treated as such.

The complete collection of sheets (including the introductory sheet) is freely available from different reference websites (a.o. [opalis.eu](http://opalis.eu), [nweurope.eu/fcrbe](http://nweurope.eu/fcrbe), [futureuse.co.uk](http://futureuse.co.uk)).

Non-exhaustive directories of dealers in reclaimed building materials are available on [www.opalis.eu](http://www.opalis.eu) and [www.salvoweb.com](http://www.salvoweb.com).

---

Interreg FCRBE partnership: Bellastock (FR), the Belgian Building Research Institute / BBRI (BE), Brussels Environment (BE), the Scientific and Technical Center of Building / CSTB (FR), Confederation of Construction (BE), Rotor (BE), Salvo (UK) and University of Brighton (UK).

The information contained in this document does not necessarily reflect the position of all the FCRBE project partners nor that of the funding authorities.

Unless explicitly stated otherwise, the content of these sheets is credited in the Creative Commons Attribution NonCommercial – Share Alike format (CCBY-NC-SA).



Unless explicitly stated, the images used in this document belong to © Rotor vzw/asbl or © Opalis. Any other image has been the subject of a systematic request for authorisation from their authors or rightful owners. When this request has not been answered, we assumed that there were no objections to the use of the image. If you feel that this interpretation is unreasonable, please let us know.





**Material description**

**By definition, natural stone kerbs are linear or curved elements of more than 30 cm in length making it possible to delimit circulation spaces such as roads, pavements, paths and other outdoor facilities. Their role is in particular to protect pedestrians from road traffic, to keep the surface coating in place and to help drain rainwater.**

For a long time, they were cut manually with a spike, chisel and mallet, using traditional techniques. This old kerbs can be recognized by their more irregular contours. It was gradually squeezed out by increasingly regular standardized elements resulting from mechanical sawing. Today, concrete tends to replace natural stone for the production of new kerbs.

Like other natural stone materials, the reclamation of natural stone kerbs remains a relatively well established practice in public works and and construction. There are many companies specialising in the recovery and resale of this material. The supply of reclaimed kerbs is stable although large batches (over 500 linear metres) of identical kerbs may be more difficult to collect.

Kerbs are often diverted to make stair treads, coping, landscaping elements, bollards, etc. This fact sheet mainly focuses on the use of natural stone kerbs for roads and landscaping.

The reclamation market has a wide variety of kerbs models. These often reflect historical and regional specificities. Several criteria make it possible to distinguish them:

→ *Type*. There are mainly two main types of reclaimed natural stone kerbs:

- “Countryside” kerbs - also called “rustic” kerbs. They have rather irregular contours and faces cleaved or re-cut manually, are relatively short (30 to 50 cm) and are mainly used for landscaping.
- “Town” kerbs - also known as “road” kerbs. They have more regular contours and one or more flat faces, sawn or squared, are longer (50 to 200 cm) and generally come from roadworks.

→ *Geological origin*. Many types of rocks were used in the manufacture of kerbs. Among the most common on the reclamation market, we find sandstone, porphyry, blue stone and limestone for “countryside” kerbs. Among the most common materials for town kerbs, we find granite (pink or grey), blue stone and white limestone, in all their local variations. There is also kerbs in basalt, gneiss, travertine, slate and other rocks but these are less common on the reclamation market.

→ *Profiles*. Different kerb profiles can meet (see figures). The most common on the reclamation market are straight or rounded kerbs. Curved kerbs, corner pieces and lowered kerbs are to be found more rarely.



Kerbs in old natural stone (<19th century) - manually cut - thick and irregular. © stonecurators.com



Natural stone kerbs later in the early 20th century - made using power tools - uniform and precise appearance. © stonecurators.com



Kerbs in old natural stone (19th - 20th century) - the upper face is sawn and the other faces cut manually - more regular shape. © stonecurators.com



Blue stone “town” kerbs. Road development. © Carrière de la Hazotte



Blue stone “countryside” kerbs. Landscaping. © Carrière de la Hazotte

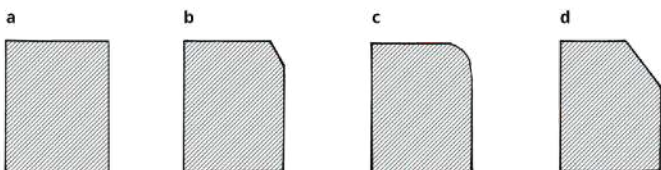

- a. Straight profile
- b. Chamfered
- c. Bullnosed
- d. Half battered

Commonly found kerb profiles



## Natural stone kerb



Reclaimed sandstone kerbs



Reclaimed kerbs in grey granite



Reclaimed kerbs in Swedish pink granite



Reclaimed kerbs in blue stone (limestone)



Reclaimed white limestone kerbs

→ **Dimensions.** Usually the reclaimed kerb is of parallelepiped shape and has variable lengths, widths between 12 and 30 cm and heights between 20 and 40 cm. However, it is not uncommon to find elements with more specific dimensions (for example: low or lowered kerbs, slanted kerbs, etc.).

→ **Appearance.** The diversity of rocks is reflected in a wide range of colours, including within the same family: grey, beige, ochre, brown, pink, bronze, etc. A specific vocabulary is used to designate the stone inlays: veins, grains, strata, flames, stains, etc.

In addition to the original appearance of the rock, the kerbs can bear the marks of their cutting method (cleavage, sawing) and of their original finish (flaming, sanding, shot blasting, bush hammering, etc.). Over time, their appearance also varies according to the stresses of use: softening, polishing of the visible face, traces of paint, mortar or bitumen, development of organisms (mosses, lichens), etc.

When a re-machining of the reclaimed kerb is envisaged (sawing, squaring, milling, etc.), this will generally modify the appearance of the visible faces.

→ **Connections.** In some cases, the kerbs have a system of notches (male and female) at their ends. The precise assembly of the kerbs is highly dependent on the condition of this system. If necessary, it is possible to saw the ends (of all or part of the batch) to facilitate its installation.



Lowered kerb profile



Notched kerb (blue stone)



Notched kerb (granite)

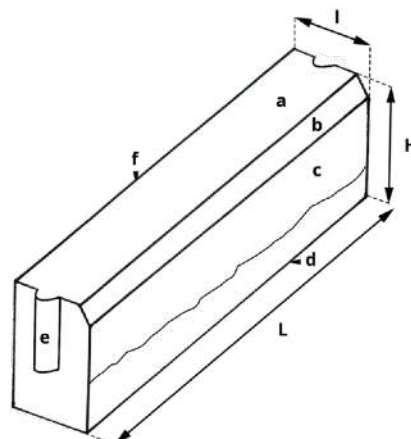

General anatomy of a reclaimed natural stone kerb

- a. Upper face (specific finish)
- b. Visible edge (with chamfer, bullnosed or half battered)
- c. Front face (specific finish on part of the height)
- d. Underside (rough sawn or cleaved)
- e. End (notched or rough sawn or cleaved)
- f. Rear face (rough sawn or cleaved)

$L \times W \times H$ : Length x Width x Height





**Material reclamation**

**Natural stone kerbs are good candidates for reuse, either on-site or through the professional channels of material resellers. They can also ensure the supply of batches of kerbs ready for installation. They are able to ensure the smooth running of the following operations:**

→ *Dismantling test* (or expert opinion). In practice it makes it possible to ensure the feasibility and profitability of a removal. An “expert eye” generally makes it possible to estimate the interest of a batch based on plans, photos, historical documents or by an on-site visit. The focal points for kerbs will be among others:

- the general condition of the batch and the laying method: condition of the stone, formats and dimensions, nature of the laying bed, characteristics of the joints, etc.
- commercial interest, depending on model, quantity, salvage and resale potential, specific regional particularities, etc.
- logistics arrangements: especially in terms of deadline, working time, handling, transport, etc.

→ *Removal*. The careful dismantling of kerbs must ensure the safety of the workers and the integrity of the recovered elements. Particular attention must be paid to the risks associated with the presence of underground service networks (cables and buried pipes). The risk of deterioration of the material is generally low during dismantling, except for elements made of soft stone, or of reduced section, requiring increased attention. The kerb is first unhooked using mechanical devices (i.e. demolition hammer) then moved using suitable lifting tools (i.e. kerb grip).

→ *Cleaning and sorting*. The collected kerbs are sorted by qualities, colours and dimensions. Elements showing deterioration (disintegration) or significant defects are discarded (in the case of kerbs in sedimentary rocks, sandstone or limestone, it is important to ensure that the cleavage plane or sedimentation plane is parallel to the direction of laying). Cleaning with water (high pressure) or by scraping is generally sufficient to remove laying residues, jointing products and other elements which could adhere to it.

→ *Treatments*. While some kerbs can be re-used as is after a rough cleaning, others may require additional operations such as:

- *Sawing*: in order to obtain flat and vertical side faces or to homogenize the dimensions of the kerbs (for example, to give them a constant height in order to facilitate their installation). It is common to saw off the ends to make up for any damage or to adapt the notch systems.
- *Sizing and machining*: in order to resume and correct the profile of the kerbs and ridges.
- *Finishing*: in order to homogenize the appearance of the stone or give it a rough appearance on the visible parts. Several techniques are possible depending on the nature of the stone and the expected performance: bush hammering, sanding, flaming, shot blasting, pitting, etc. A specific vocabulary determines the type of finish depending on the type of rock concerned. Some examples :



*Bush hammered blue stone*



*Chiselled blue stone*



*Flamed granite*

- *Cleavage*: kerbs that's unsuitable for cutting can be split in order to form paving stones.

These various operations can be carried out by specialized suppliers within their facilities. They can also be considered on site, provided that the site logistics allow it.

**Design Tip!**

*In general, the cost of kerbs increases with the number of operations required. When usage requirements allow, rough kerbs are the most economical solution. Sawing is however an exception to this rule since it allows, in a relatively simple operation, to double the quantity of potentially available material! However, it should be ensured that the cut elements meet the requirements of use (in particular for their dimensions).*



*Kerb sawing © Carrière de Bonneuil-sur-Marne*



*Kerb finishing by bush hammering © Carrière de Bonneuil-sur-Marne*



*Kerb cleavage © Arnaud Bouissou - TERRA*



## Natural stone kerb

→ *Storage and packaging.* Natural stone kerbs are generally stored outside, packaged and strapped on pallets. They are arranged horizontally. Ideally, they are separated by wedging elements in order to limit the risk of damage. Metal straps should be avoided as there is a risk of staining the stone (rust). Ready-to-install kerbs are clearly identified and labelled in uniform batches. Short kerbs (such as “countryside” kerbs) can also be packaged in a big bag or in a crate. The packaging must take into account the large mass of the elements (the pallets may have to support loads of more than 2 t). Appropriate means of transport and lifting are also required.

Reclaimed natural stone kerbs are generally sold by the linear metre or by the ton. Most suppliers are able to provide a technical sheet showing their main characteristics (type of rock, nominal dimensions and tolerances, finish, intended applications) and, in certain cases, their origin.



Bulk storage © Pavés de rue



Storage on strapped pallets © Hofman NV-SA



Pallet storage © Van Dijk



Paris paving depot, Bonneuil-sur-Marne. Stock of cobblestones and stone kerbs ready to be sorted, cleaned and reused in sites in the city of Paris (FR) © Ville de Paris, Florence Morisson.

### Did you know?

Some towns have their own stock of road materials. In Paris, for example, it is mandatory to reuse suitable paving and kerb stones on site or to divert them to a centralized stock, which contractors must also use for new developments. This platform, set up more than 20 years ago, ensures, among other things, the collection, sorting, cleaning and storage operations of Parisian paving and kerb stones. In addition to minimizing the costs associated with the purchase of new materials, it would prevent the dumping of 7,000 to 8,000 tonnes of granite per year, corresponding to 600 tonnes of not emitted CO<sub>2</sub>. (Source : Paris City Hall Maintenance and Supply Centre (CMA, ADEME).





## Applications and laying

**Reclaimed natural stone kerbs are mainly used for marking out roads or for less demanding landscaping applications (delimitation, low wall, steps, benches, bollards, etc.).**

The choice of a type of kerb depends on the demands specific to the intended use: traffic, climatic conditions, town planning rules, etc. On roads, the kerb must be able to withstand impact from the wheels and friction from tyres. They must also be able to channel rainwater. It is therefore important that they be placed on a solid foundation and sufficiently buttressed so as not to come free.

The majority of the points of attention related to the installation of reclaimed stone kerbs do not differ from those linked to new ones - in particular, and in a non-exhaustive way: type and dimensions of the kerbs, type of foundation and of the laying layer, type of grouting, buttress arrangements, water runoff, type of road surface covering, etc.

It is up to the designer/specifier to rely on the regulations, the rules of the art and the technical standards in force in this field. It should be noted that some local reference guides on the installation of stone cladding elements already include the case of reclaimed kerb stones (for example: the Quali-route standard developed in the Walloon Region, Belgium).

Depending on the planned batches, the reclamation of kerb stones may require special attention to the following aspects:

- Variable height of the kerbs. It is possible that the kerbs have different heights due to the irregularities of the underside. If necessary, this can be corrected by adapting the foundation layer.
- Variable length of the kerbs. Due to the variable length of the kerb stones, it is more practical to use clamps which grip the edges across their width. However, this implies that the kerb is laid before paving, so that there is sufficient space for the clamp.
- Visible traces. Kerbs with visible traces of another material (asphalt, paint, mortar, etc.) can be evenly distributed over the length concerned. If necessary, the kerb stones that have these traces can also be reserved for less demanding uses in this regard.

- Irregularities of the extremities. If necessary, these can be sawn to provide flat side surfaces.
- Junction with special kerbs. When new elements are incorporated into the structure (for example: lowered kerbs, curved kerbs, corner elements, etc.), it is necessary to ensure their compatibility with the planned reclaimed kerbs.

Furthermore, adequate installation requirements must be specified to cover the wide variety of possible applications of reclaimed kerbs.

In general, finding a batch with very specific characteristics can be complicated. It is often preferable to identify a batch of raw reclaimed kerbs and to consider additional processing operations. The expertise of professionals can be invaluable in this regard.

The following characteristics can be described and specified when drafting the technical requirements related to the delivery of a batch of reclaimed kerb stones:

→ **Batch composition.** The batch of reclaimed kerbs is made up of elements of the same type ("countryside" or "town" kerbs), of the same geological nature (sandstone, granite, porphyry, white limestone) or even of the same original use (use on busy roads, areas subject to frost, etc.). However, mixed kerb stone batches may be suitable for less demanding applications.

→ **Dimensions.** In general, the dimensions must be uniform in width and thickness. The kerb stones must be sufficiently flat and straight. Depending on the design, the batch can be split into sub-batches of different dimensions. To limit costs and facilitate the identification of recovered kerbs batches, it is preferable to be flexible enough on the dimensions by opting for a free-length installation, by defining only a minimum length (for example, min. 40 cm) or by setting a fairly wide gap (for example, length between 80 and 120 cm). If necessary, it is also possible to insist on more precise dimensional characteristics (as well as tighter dimensional tolerances). This may result in a heavier transformation of the material (sawing, re-machining).

→ **Texture and finish.** Depending on the requirements (functional and aesthetic) and the type of rock, the appearance of the visible faces (bush-hammered, flamed, scabbled, shot-peened, etc.), non-visible faces and ends

(sawn, cleaved) should be specified. Depending on the burial depth, the face may only be squared over part of the height. This must then be specified.

→ **Profile.** ditto If necessary, the profile of the kerb stones and the condition of each edge should be specified (straight sawn, chamfer, bullnose, half battered, without requirements, etc.). For a greater profile uniformity, it is necessary to be precise on the dimensions (and their respective dimensional tolerances) and to envisage a possible transformation of the edges.

→ **Hue.** By nature, natural stones have a wide variety of colours and appearances. Depending on usage requirements (for example, in the context of heritage renovation), it is possible to specify this characteristic by referring to a general hue or to a specific colour.

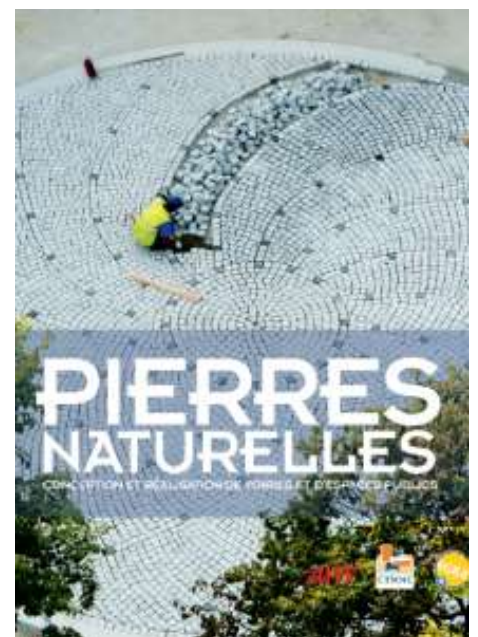

*Pierres naturelles - Conception et réalisation de voiries et d'espaces (2019) (In french), RGRA, 440 p., ISBN : 978-2-913414-52-5*



→ **Condition.** In addition to traces of mortar, paint and bitumen residues, reclaimed kerbs may show minor alterations such as signs of surface wear, chips, light cracks, craters, light flaking, stains, leftover moss, etc. These deteriorations can influence the technical and aesthetic performance of the kerbs, as well as their re-installation, but do not constitute a major obstacle to reclamation - except for very specific uses (see § "Characteristics and fitness for use").

Depending on the nature of the rock, other aspects can be considered as major imperfections. For example, kerbs in sedimentary rock (i.e. sandstone, limestone) must necessarily present a cleavage plane (and stylolithic joints) parallel to the direction of laying, otherwise the stone will disintegrate. Another example: certain limestone rocks (i.e. blue stone) may have stylolithic joints liable to weaken the stone. These imperfections can sometimes be suitable for parts of kerbs that are not visible. To a large extent, the existing technical documentation makes it possible to assess these various aspects on a case-by-case basis. Professionals can also be consulted.

It is up to the designer/specifier to define the degree of imperfection tolerated, according to the defined use and the installation conditions, by specifying the degree of acceptable alterations (for example: chips, cracks and flaking < x cm<sup>2</sup> tolerated on visible sides, broken corners and edges tolerated on invisible parts, etc.).

Note that kerb stones with irregularities or traces of bitumen are perfectly suited to certain applications and are less expensive than more calibrated kerbs.

→ **Quantities.** To increase the quantity of kerb stones available, the designer/specifier may consider combining different batches (for example: granite + sandstone) and/or planning a deadline for the supplier to be able to bring together the required quantity. In the case of an on-site reclamation scenario, it is advisable to provide a reserve stock of kerb stones in order to carry out subsequent repairs and replace damaged kerbs.

Most professional suppliers are able to ensure that delivered batches meet these requirements. A control test procedure based on a contractual sample and sampling upon receipt can be set up.

Most of the reclaimed building materials are sold as is. The conditions of sale may however contain special guarantees specific to the material. Some suppliers are able to indicate the origin of the material and/or provide documentation on the product purchased (for more information, see the introductory sheet).

**Design tip!**

*It is better to order a quantity expressed in linear metres rather than in number of pieces, given the irregular lengths of the reclaimed kerb stones.*



Example of stylolithic joints



Place de la Bastille, Paris. Reclamation of 10,000 old kerb stones sawn in half to be transformed into flagstones (FR). © Benjamin Randow



Reclamation of kerb stones for staircase steps (FR). © Noblema





**Characteristics and fitness for use**

The harmonised European standard EN 1343 establishes the relevant characteristics (depending on the context) in order to determine the fitness for use of natural stone kerbs intended for exterior paving. Although detailed for new materials from the extraction and processing of natural stones, these characteristics may prove useful in considering the specific case of reclaimed kerb stones.

Characteristics	Comments
<b>Geological origin and petrographic description</b>	The reclaimed kerb stones come from works that may have been made from batches of multiple origins. If it is possible to visually characterize the type of rock present, it is however more difficult to affirm with certainty that their geological origin is identical, unless there are records that allow it to be attested (for example: a certificate of origin, archival documents ...). This is all the more true for the batches made up of kerb stones of various origins.
<b>Geographical origin</b>	As with the geological provenance, information on the original geographic provenance of a batch of reclaimed kerb stones is difficult to certify with any certainty. On the other hand, we can deduce certain characteristics if we know where the kerb stones were removed. Thus, kerb stones in good condition that have been dismantled in an area subject to strong freeze/thaw cycles are likely to show good frost resistance. Another example: kerb stones in good condition coming from a street subjected to intensive traffic by heavy vehicles testify in some way to their good compressive strength. Thus, in the absence of information on the original quarry, it may be useful to have information on the roadway where the kerb stones come from.
<b>Bulk density and open pores</b>	<p>These characteristics are specific to each stone. The density [kg/m<sup>3</sup>] gives an indication of the degree of compactness of the stone. In general, the more compact a rock, the less porous it is.</p> <p>The open porosity of a stone is the proportion of interconnected pores that are accessible to water. It is expressed in [% by volume]. It is usually estimated by measuring the water absorption (mass of water absorbed in relation to the mass of a dry test piece). This characteristic influences in particular the degree of resistance to stains and soiling. It does not directly affect the frost sensitivity of the stone element (it is rather its capacity to return the absorbed water that matters at this level).</p> <p>This information can be estimated based on technical documentation relating to natural stones (see <i>table below</i>). If necessary, these characteristics can be measured more precisely by an identity test as defined by the test EN 1936.</p>
<b>Geometric characteristics</b>	<p>These characteristics can be found out by taking simple measurements. They are closely linked to the degree of sorting and cleaning of the reclaimed kerb stones as well as to the transformation operations undertaken on the material. In the case of kerbs intended to be re-machined or re-cut, it is advisable to define with the supplier the dimensional tolerances applicable to each of the dimensions (width, thickness, length, radius of the bullnose, geometry of the chamfer, etc.) the equipment required, the type of stone and the functionality of the works (these various aspects are described in standard EN 1343). The requirements in terms of flatness and straightness should also be detailed.</p> <p>In general, raw reclaimed kerbs show irregularities in shape related to the original manufacture and the degree of wear.</p>
<b>Slippage</b>	<p>This feature influences the comfort and safety of users. It mainly depends on the roughness and texture of the surface. It can be assessed visually. The coarser it is, the more non-slip it is. This characteristic changes over time under the influence of the surface wear, the presence of dirt, the maintenance conditions, the slope, the density of the joints and the climatic context (rainfall). The in-depth evaluation of the slip resistance (managed by the EN 14231 test standard) is relevant when the structure is intended for pedestrian traffic. This standard further stipulates that embossed or cleaved squared kerb, with a surface roughness greater than 1.0 mm, meet the slip requirements without prior test measurements.</p> <p>In the case of reclaimed kerbs, a specific finishing treatment adapted to the type of stone can be considered. Certain finishing treatments (flame treatment, for example) may be applied during use in order to meet the requirements in force.</p>
<b>Wear resistance</b>	This durability characteristic depends on the intensity and type of traffic, the presence of abrasive particles and the maintenance conditions. If there is a test standard which allows this characteristic to be evaluated with precision (EN 14157 - Capon test), it can also be used for reclaimed kerb stones, by relying on the way in which they have withstood the demands of their first use. In general, granites and basalts are suitable for intense stress and are more resistant to wear than sandstones and limestones.



Characteristics	Comments																
<b>Flexural strength</b>	<p>The flexural strength R<sub>f</sub> [MPa] is a mechanical characteristic which provides information on the capacity to resist bending forces in use. It varies according to the type of stone and is generally determined by means of bending tests as per standard EN 12372.</p> <p>The flexural strength makes it possible to determine the admissible breaking load [kN] of the kerb, according to their dimensions, and to the following formula:</p> $P = \frac{R_f \times W \times t^2}{1500 \times L \times F_s}$ <p>where P : breaking load [kN]  W, L, t : width, length and thickness [mm]  R<sub>f</sub> : flexural strength [MPa]  F<sub>s</sub> : safety factor, generally F<sub>s</sub> = 1.6</p> <p>In the case of roadside kerbs, the applicable requirements can be summarized in the following table:</p> <table border="1"> <thead> <tr> <th>Recommended use</th> <th>Breaking load (kN)</th> </tr> </thead> <tbody> <tr> <td>decoration</td> <td>No requirements</td> </tr> <tr> <td>pedestrian use only</td> <td>&gt; 0.75</td> </tr> <tr> <td>pedestrian and cycling areas</td> <td>&gt; 3.5</td> </tr> <tr> <td>occasional access for light vehicles, garage entrances</td> <td>&gt; 6</td> </tr> <tr> <td>pedestrian traffic area, market places, occasional circulation of delivery/rescue vehicles</td> <td>&gt; 9</td> </tr> <tr> <td>pedestrian traffic area frequently used by heavy trucks</td> <td>&gt; 14</td> </tr> <tr> <td>roads and streets</td> <td>&gt; 25</td> </tr> </tbody> </table> <p>However, in the case of reclaimed kerbs, it can be assumed that elements which have been subjected to high stresses during their life will continue to meet similar or lower requirements. A detailed examination of the conditions of initial use therefore makes it possible to assess the flexural strength capacity of the reclaimed kerbs, without any specific test measurement.</p>	Recommended use	Breaking load (kN)	decoration	No requirements	pedestrian use only	> 0.75	pedestrian and cycling areas	> 3.5	occasional access for light vehicles, garage entrances	> 6	pedestrian traffic area, market places, occasional circulation of delivery/rescue vehicles	> 9	pedestrian traffic area frequently used by heavy trucks	> 14	roads and streets	> 25
Recommended use	Breaking load (kN)																
decoration	No requirements																
pedestrian use only	> 0.75																
pedestrian and cycling areas	> 3.5																
occasional access for light vehicles, garage entrances	> 6																
pedestrian traffic area, market places, occasional circulation of delivery/rescue vehicles	> 9																
pedestrian traffic area frequently used by heavy trucks	> 14																
roads and streets	> 25																
<b>Resistance to freezing/thawing (and de-icing salts)</b>	<p>For an exterior application, the natural stone elements must be able to withstand freezing/thawing without their appearance or their mechanical characteristics being affected. The source and condition of a batch of reclaimed kerb stones can provide a useful guide to determining their resistance to freezing/thawing. Many old kerb stones are in fact likely to have withstood, during their first use, more freeze/thaw cycles than what is recommended by the test standard which allows this performance to be assessed (EN 12371). It is therefore important to find out about the geographical origin of the batch to ensure the original climatic conditions (for example, a batch coming from a continental climate in northern Europe will probably be suitable for an application in the Mediterranean climate of the South of France. The reverse is not necessarily true). Generally, less resistant kerb stones that have suffered frost damage will probably have been discarded during the sorting and cleaning steps.</p>																
<b>Dirt resistance</b>	<p>This characteristic depends greatly on the porosity of the stones and the degree of finish. It is possible to assess this performance by observing the degree of soiling on the visible face of the untransformed (un-sawn) reclaimed kerb stones. If necessary, specific surface treatments can also be recommended to improve this performance, by slowing the infiltration of oily substances into the voids of the stone (surface treatment with silanes, siloxanes, teflon, etc.).</p>																

As an indication, the following table shows some of the known performances of some types of rock constituting kerb stones which are frequently reclaimed. It is important to point out that each stone has its own characteristics and that two batches of kerb stones of the same rock can however have quite different performances.

	Bulk density (kg/m <sup>3</sup> )	flexural strength (MPa)	Porosity	Wear resistance
<b>Sandstone</b>	2000 - 2700	20 - 30	little porous (0.5 to 10%)	++ (+)
<b>Soft limestone (ex: white stone)</b>	< 2500	-	porous (5 to 50%)	++
<b>Compact limestone (ex: blue stone)</b>	> 2500	10 - 25	little porous (0.2 to 5%)	++
<b>Porphyry</b>	2000 - 2800	15 - 30	very little porous (0.2 to 2%)	+++
<b>Granite</b>	2500 - 3000	15 - 30	very little porous (0.2 to 2%)	+++





**Availability**

There are many professionals who sell reclaimed natural stone kerbs. However, supplier stocks are not always stable. It is recommended to check with professionals early enough in the event of a large order (several hundred linear metres).

**Indicative prices (Excl. tax, for private customers)**

A non-exhaustive sampling of the reclamation market in North West Europe (Belgium, France, Great Britain and the Netherlands) made it possible to extract some indicative prices. These vary depending on the format, the size and type of stone, as well as the degree of sorting and cleaning requested.

- Reclaimed “countryside” kerb:  
~ 25 - 30 € / linear metre
- Reclaimed “roadside” kerb:  
~ 40 - 70 € / linear metre

**Find specialised businesses**



[salvoweb.com](http://salvoweb.com)

[opalis.eu](http://opalis.eu)



Place du Panthéon, Paris (FR). Les Monumentales (Emma Blanc, Collectif ETC, Genre et Ville, Albert and co.). Reclamation of 400 granite kerb stones (or blocks) in landscaping. © Lucas Bonnel et © Samuel Colin-Canivez



**Did you know?**

The pink granite street elements that are currently on the reclamation market in Belgium originate from Swedish quarries. These paving and kerb stones were used as ballast in the holds of ships traveling between Belgium and Sweden. Once unloaded in the port cities, they found new uses there in the work of fitting out public spaces.



Lower Mystic Lake House (USA). Reclamation of stone kerbs. © matthew-cunningham.com



According to the sources and types of stone, reusing 100 metres of reclaimed natural stone kerbs prevents the production of ~ 680 to ~ 7880 kg of CO<sub>2</sub> equivalent related to the manufacture of new kerb stones (production phase only). According to sources, this corresponds to the emissions of a trip of ~ 4050 to ~ 47250 km in a small diesel car.

If the reclamation of natural stone kerbs replace new concrete kerbs, this gain is also interesting.

**Embodied carbon (Cradle to gate - production A1-A3)**

	kg CO <sub>2</sub> eq./linear m	kg CO <sub>2</sub> eq./kg
INIES database (FR) – Generic data– Natural stone kerb *	35,8	-
INIES database (FR) - Generic data - Concrete kerb **	29,0	-
ICE database (UK) - Granite***	78,8	0,7
ICE database (UK) - Limestone ****	10,1	0,09
ICE database (UK) - Sandstone *****	6,8	0,06

\* Indicative value to ensure the function of 1 linear metre of natural stone kerb for a reference lifespan of 150 years.

\*\* Indicative value to ensure the function of 1 linear metre of concrete road kerb and the collection of runoff water for a reference lifespan of 50 years.

\*\*\* Indicative value for 1 linear metre of granite kerb (width = 15 cm, thickness = 30 cm, density = 2500 kg/m<sup>3</sup>).

\*\*\*\* Indicative value for 1 linear metre of limestone kerb (width = 15 cm, thickness = 30 cm, density = 2500 kg/m<sup>3</sup>).

\*\*\*\*\* Indicative value for 1 linear metre of sandstone kerb (width = 15 cm, thickness = 30 cm, density = 2500 kg/m<sup>3</sup>).

**Disclaimer**

This sheet is intended for designers, specifiers and other members of construction project teams wishing to reuse this building material or product. It is part of a collection of sheets aimed at bringing together the available information to date that is likely to facilitate the reuse of building materials and products.

This sheet has been produced by Rotor vzw/asbl within the framework of the Interreg FCRBE project - Facilitating the Circulation of Reclaimed Building Elements, supported by the entire project partnership. Sources of information include the experience of reclamation dealers and involved project partners, lessons learned from exemplary projects, available technical documentation, etc.

The sheets have been produced between 2019 and 2021. As the reclamation sector is evolving, some information, notably regarding pricing and availability, may change over the time. When the text refers to European standards, it is up to the project team to refer, if necessary, to their national implementations and local specificities.

It is important to note that the information presented here is not exhaustive or intended to replace the expertise of professionals. Specific questions are always project related and should be treated as such.

The complete collection of sheets (including the introductory sheet) is freely available from different reference websites (a.o. [opalis.eu](http://opalis.eu), [nweurope.eu/fcrbe](http://nweurope.eu/fcrbe), [futureuse.co.uk](http://futureuse.co.uk)).

Non-exhaustive directories of dealers in reclaimed building materials are available on [www.opalis.eu](http://www.opalis.eu) and [www.salvoweb.com](http://www.salvoweb.com).

---

Interreg FCRBE partnership: Bellastock (FR), the Belgian Building Research Institute / BBRI (BE), Brussels Environment (BE), the Scientific and Technical Center of Building / CSTB (FR), Confederation of Construction (BE), Rotor (BE), Salvo (UK) and University of Brighton (UK).

The information contained in this document does not necessarily reflect the position of all the FCRBE project partners nor that of the funding authorities.

Unless explicitly stated otherwise, the content of these sheets is credited in the Creative Commons Attribution NonCommercial – Share Alike format (CCBY-NC-SA).



Unless explicitly stated, the images used in this document belong to © Rotor vzw/asbl or © Opalis. Any other image has been the subject of a systematic request for authorisation from their authors or rightful owners. When this request has not been answered, we assumed that there were no objections to the use of the image. If you feel that this interpretation is unreasonable, please let us know.



**Material description**

**Clay pavers (also called “paving bricks” or “clinkers”) are a fairly common exterior cladding material in Western Europe (mainly the Netherlands, Germany and northern Belgium).**

These pavers are particularly suitable for reuse. A study carried out in the Netherlands in 2009 and commissioned by brick manufacturers estimated the percentage of clay pavers reused by municipalities and individuals to be 90%. The reasons for this impressive rate are in particular the very high resistance of the pavers, their relative ease of disassembly and their ability to age well.

Although they are similar to building bricks, they differ from them in their production mode and their properties. Clay pavers generally consist of a mixture of clays (primary and secondary), volcanic rocks and/or grog, to which are optionally added natural pigments. These ingredients are mixed with water, kneaded, shaped, dried and then cooked at a temperature of 1,100 to 1,200° C. The finished product is very hard with low porosity, which is ideal for exterior paving. The pavers are resistant to extreme frost, pressure, wear and aggressive substances.

Clay pavers are considered to be very durable. They can easily retain their original properties for over a century - and sometimes even several centuries. As their laying method is traditionally reversible (laying on a sand bed), they are commonly recovered for reuse. This practice is very common in the Netherlands, where it is not uncommon to find suppliers of reclaimed pavers (who sometimes supplement their offer with new pavers).

Until the beginning of the 20th century, clay pavers were sometimes considered as a by-product from the production of masonry bricks (called “ordinary”) in traditional kilns. These ensured an uneven distribution of heat so that a batch of bricks loaded at the same time showed different degrees of firing. The most fired elements and therefore the hardest were then reserved for exterior paving applications. Subsequently, with the expansion of motorised traffic, specific kilns were designed to industrially produce clay pavers.

Clay pavers should not be confused with the ordinary bricks used in the construction of walls (less hard and more porous), nor with their concrete counterparts (also sometimes called “clinkers” made from concrete and cement). The latter can be recognised by the presence of aggregates in the mass of the paver. In this document, only clay pavers are discussed, although several principles also apply to the reuse of other paving materials.

There are a great many models of reclaimed clay pavers, which sometimes reflect historical regional specific features. Several criteria make it possible to distinguish them:

→ *Production mode - form*

- *Moulded pavers*: pavers are formed separately by moulding the clay using a mechanical press. The upper and lower faces sometimes differ in terms of their texture (the upper face may be slightly more sanded or rough). This is a very common type in continental Europe.
- *Extruded pavers*: clay is pressed through a mould into a continuous mass and cut into regular sized pieces. The finish of extruded pavers is generally smooth on all sides. They are less porous due to the higher proportion of primary clay used in their manufacture. This is a very common type in Germany and in the United Kingdom.

→ *Production mode - baked*

- *“Old baked”*: traditionally, pavers were baked in brick ovens heated with wood and charcoal. As the heat distribution in the oven was not uniform, this led to variations in the properties of the pavers resulting from the same firing (porosity, hardness, colours, etc.).
- *Modern baking, or “New baked”*: contemporary pavers are mainly produced in industrial tunnel kilns, capable of ensuring a more uniform distribution of the firing temperature. Therefore, recent pavers have more uniform properties (but not necessarily better) than their predecessors.

The terms “Old baked” and “New baked” are not scientific terms. Rather, they are trade names, the use of which may vary from one supplier to another. Sometimes, newly produced clay pavers are also referred to as “Old baked” and, vice versa, there are “New baked” clay pavers on the reuse market. In case of doubt, ask your supplier for more information about the origin of the elements.

→ *Appearance*. Depending on the model and the degree of wear, reclaimed clay pavers have a smooth, rough, slightly sanded or more textured appearance. Edges are straight, rounded or blunt, with or without chamfers. Some recent pavers are hammered on purpose to mimic natural wear and give them a rustic appearance. They should not be confused with genuinely reclaimed pavers! So-called “draining” pavers have growths of a few millimetres on the edges (called crosspieces or spacers) to maintain a systematic gap and allow the infiltration of rainwater. Reclaimed clay pavers may have paint residues (such as road markings). Slight traces of residual mortar or sand may also remain.



Reclaimed clay pavers



Reclaimed concrete pavers



Reclaimed masonry bricks



**Clink !**

Did you know? The word "clinker" is derived from the clear sound that clay pavers make when they collide.

→ **Colours.** The color of clay pavers is determined by the composition of the clay, the firing temperature and the possible presence of mineral additives. The colours often have brown, red, purple and yellow tones.

→ **Formats.** There are many formats of reclaimed clay pavers, depending on the original application and regional specificities. Indicatively, *Table 1* shows some common paver formats on the reclamation market (mainly in Dutch-speaking regions). It must be noted that the exact dimensions may differ slightly from the values below. There are sometimes other less common formats (e.g. square, long, etc.)



Showroom of a supplier of reclaimed clay pavers © VSB Sierbestrating

*Table 1: Dimensions of the most common reclaimed clay paver formats.*

Format	Length x width (mm)	Thickness (mm)	Number of pieces per square metre
Waal format	~ 200 × 50 (ratio 4:1)	~ 60 to 90	~ 100 (laying flat)
Thick format	~ 200 × 67 (ratio 3:1)	~ 60 to 90	~ 73 (laying flat)
Pebble format	~ 200 × 100 (ratio 2:1)	~ 50 to 90	~ 50 (laying flat)
Rijntjes format	~ 180 × 45	~ 60 to 90	~ 120 à 145 (laying on the edge)
Ijseltjes format	~ 160 × 40	~ 60 to 70	~ 135 à 160 (laying on the edge)

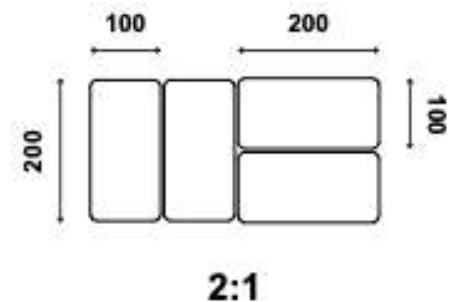
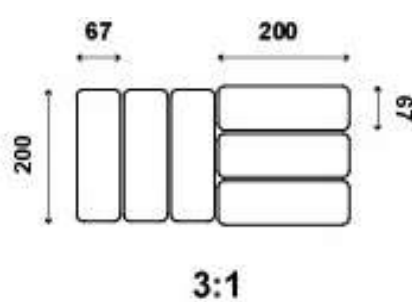
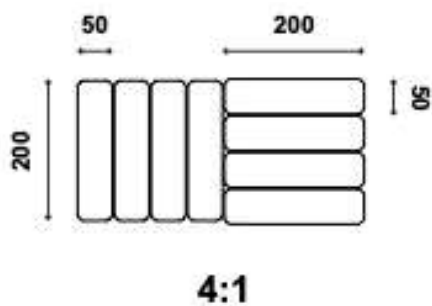

Waal format, mix of colours © Rebricks



Thick format, red © Rebricks



Pebble format, red © Rebricks



**Material reclamation**

**In the vast majority of cases, clay pavers are easily recovered. For reuse on the same site, it is possible to carry out on-site sorting, and cleaning operations, as far as conditions allow (especially in terms of space). Most of the time, the pavers are dismantled by a specialized company which can also take care of delivering batches ready for laying. These professionals are able to ensure the smooth running of the following operations:**

→ *Preliminary research and dismantling tests.* These make it possible to verify the feasibility and profitability of the removal. An "expert eye" generally makes it possible to estimate the reuse potential during an on-site visit or based on photos and technical information relating to the pavers' original manufacturer, the model and dimensions. It may be useful to collect information relating to the original roadway in order to corroborate certain characteristics of the material (see § "Characteristics and fitness for use").

The type of bedding and the joint characteristics are the main factors which affect the ease of dismantling. In general, the pavers are laid on a bed of sand with sand joints (flexible laying), a wholly reversible laying method. However, the presence of cement or asphalt mortar (rigid laying) can complicate removal.

It should also be ensured that the pavers have not been contaminated. Three types of contamination can be checked:

- Ground or paver foundation contamination (such as asbestos, tar, petroleum on old industrial sites) likely to impact the pavers.
- Contamination of the pavers' upper surface, for example by oil, tar, paint, thermoplastics, etc. This type of contamination is visually manifest. Often, contaminated pavers are marked before removal, in an attempt to separate them from "sound" pavers. However, limited oil pollution is sometimes admissible (see § "Hazardous substances and precautions").

- Contamination due to leaching of pavers. In rare cases, it can happen that certain old pavers release polluting substances from which they are made. To check this, laboratory analysis may be required. Sometimes specialists and/or local authorities can also provide more information on this. Research carried out in the Amsterdam region has, for example, shown that no paver exhibits a form of contamination likely to prevent its reuse in outdoor conditions (see also § "Hazardous substances and precautions").

→ *Removal.* During disassembly, the main point of attention is to make sure to maintain a certain uniformity of the batches. In practice, attention is mainly focused on the format of the pavers and less on the colour. There is little risk of material deterioration during disassembly. Pavers laid on a sand bed are usually removed mechanically using a hydraulic shovel fitted with a riddle bucket. During this step, the pavers are shaken to remove much of the sand and soil residue. At the end of this operation, the sandy and earthy fraction remaining on the pavers only represents about 3% of the mass of the pavers. In the rare cases where the pavers have not been placed on a bed of sand, it may be necessary to carry out a specific manual cleaning to remove the mortar remains (laying bed and/or joints).

→ *Treatment.* Apart from rough cleaning and quality sorting, reclaimed clay pavers generally do not undergo any treatment. Cleaning can be carried out on site or at a specialists. The batches of disassembled pavers are usually handled on conveyor belts. Sorting criteria vary depending on the supplier. In general, broken or deteriorated clay pavers are discarded (the loss rate is estimated at 10-15%). Pavers in good condition are sorted by format. Sorting by colour is not systematic. It essentially depends on the uniformity of the original batch. As a rule, the more uniform a batch of cleaned and sorted reclaimed pavers, the higher its selling price. Often, specialist suppliers combine batches of pavers that are similar but have different origins.

If there are nevertheless reasons to doubt the quality of a batch, or if the pavers have not been properly cleaned/shaken, a specific sorting can also be carried out based on a check:

- *visual:* the pavers are inspected and the items showing significant damage are rejected. Pavers can be irregular but must have at least one face in good condition. When paint, mortar or asphalt remains are present on the surface of a paver, the opposite face must be in good condition. The presence of mosses or lichens on the surface indicates a high porosity which must be taken into account for the future application.
- *auditive:* to check that the clay pavers are intact, solid and non-porous, they can be knocked together or tap them with a hard object. Clear, reverberating sound means their structural integrity has not been compromised.
- *mechanical:* the pavers are rubbed to check the porosity. A paver that is peeling is usually deemed too porous.



Removing pavers using a riddle bucket  
© VSB Sierbestrating



## Clay pavers (Clinker)

In principle, reclaimed clay pavers do not undergo any further treatment. Sometimes they are brushed or rinsed manually or mechanically before or during the palletising process. Recently, in the Netherlands, fully automated cleaning lines are used to clean/wash the pavers, to check that they do not have dimensional deviations and to package them directly on pallets using specific equipment, so that they can be replaced mechanically (see § "Applications and laying").

Pavers that break during disassembly and cleaning are largely unusable for reuse. However, it is possible to keep a small amount of half pavers for the joints and angles, depending on the type of assembly planned during their re-installation. Some professional suppliers are also able to deliver these intermediate sizes (e.g.  $\frac{1}{4}$ ,  $\frac{1}{2}$ ,  $\frac{3}{4}$ ).

→ **Storage and packaging.** Unsorted clay pavers are generally stored in bulk in outdoor silos. Once sorted, the pavers are again stored and delivered in bulk or packaged on pallets or in big bags.

Ready-to-install pavers are clearly identified and labelled in uniform batches. They are usually sold per m<sup>2</sup>. Most suppliers are able to provide a technical sheet showing the characteristics of the pavers (format, nominal dimensions and tolerances, colour, appearance, intended applications) as well as their origin.

It is advisable to involve specialised professionals to ensure the smooth running of these operations.



Pallet and big bag storage © Opalis ([VSB Sierbestrating](#))



Bulk storage © Opalis ([VSB Sierbestrating](#))



Bulk storage of reclaimed clay pavers © [Tuinmaterialen Meynen](#)





## Applications and laying

**Reclaimed pavers are mainly used as modular elements for exterior paving, for applications subject to moderate stress (pavements, pedestrian areas, squares, alleys, etc.) or more intense (roads suitable for motor vehicles, car parks, etc.). They are also suitable for civil engineering applications such as retaining walls, quays, stairs, etc., as well as interior flooring and roof terraces.**

In general, the laying of reclaimed clay pavers does not differ from that of new equivalent pavers. The choice of a type of paver depends on the stresses specific to the intended use: expected traffic, climatic conditions, noise level, permeability of the pavement, town planning rules, etc. The pavement as such is not everything. The laying technique envisaged also contributes greatly to meeting the expected requirements - in particular, and not exclusively, according to the type of foundation and the laying layer (sand, stabilised sand or mortar), the jointing, the equipment, the nature of the blocking elements, drainage, impurities, etc. Likewise, the quality of the laying can make all the difference between a floor covering that meets expectations and a covering that does not (for example, in terms of flatness). It is up to the designer/specifier to rely on national regulations, in accordance with professional standards and the technical standards in force in this field (in particular the European standard for exterior paving EN 1344).

### *Think reversible!*

*Certain laying methods complicate or even prevent the recovery of pavers. This is particularly the case with rigid laying, involving mortars and hydraulic binders. In this sense, as soon as possible and with comparable performance, it is preferable to favour a flexible laying (flexible base bed, sand bed and sand joints). Carried out in accordance with professional standards, this laying method is very resistant to stress, is easily repaired and does not cause damage such as lifting or cracking.*

The setting influences the aesthetics of the covering, its ease of laying and the number of cuts required for its realization. Certain setting, such as diagonal, herringbone and randomly matched, offer better resistance to motorised traffic (resistance to braking, acceleration and turning traffic).

The presence of a chamfer or spacer studs helps limit damage to the edges in heavy traffic. On the other hand, they are not recommended for surfaces subject to the passage of trolleys with wheels (such as shopping centres).

Reclaimed pavers are usually laid with the old side (that is, the side that was visible in the original application) up, to bring out the patina. It is also possible to invert or alternate the faces.

The following characteristics can be described and specified when drafting the technical requirements related to the delivery of a batch of reclaimed clay pavers:

→ **Batch composition.** The batch consists of same model pavers (format, colour, with or without spacers, with or without chamfer, etc.). In most cases, professional suppliers offer batches of uniform pavers, but from different origins.

→ **Format.** The dimensions of the pavers must be uniform. Batches of old pavers may have dimensional variations compared to the standard dimensions described in § "Material description". Slight variations in dimension between pavers within the same batch are also common for older pavers. In general, professional suppliers often make batches as uniform as possible. The dimensional tolerance will be determined by the designer/specifier according to the laying constraints, possibly in consultation with a supplier. Some batches are sometimes made up of pavers of unequal length.

Note that the pavers can be laid on their edge or flat. For laying methods requiring half-pavers or other adjustment pieces, it is necessary to specify the dimensions (such as  $\frac{1}{4}$ ,  $\frac{1}{2}$ ,  $\frac{3}{4}$ ) and the desired quantities.

### *Mechanical laying!*

*For the past ten years in the Netherlands, regulations have made the mechanical laying of pavers for public works compulsory in most circumstances. These measures were taken in view of the frequent replacement of certain coverings and the arduous nature of the work. In order to be able to mechanically lay the pavers, it is often necessary to pre-palletise the pavers according to the desired setting, which leaves practically no chance for small dimensional deviations or staggered shapes. Therefore, this principle is unsuitable for the most irregular pavers (often the oldest pavers). For public works, it is therefore recommended that the contracting authority agrees on this subject with the suppliers.*

→ **Colour and appearance.** Variations in colour and appearance are frequent. In the case of reclaimed clay pavers, these variations are mainly due to the production method and the origin of the batches. Palletized reclaimed pavers from professional dealers are generally mixed enough to obtain a good aesthetic result. In case of doubt, the pavers can be mixed again during placement. Since the pavers are not always sorted by colour, it is also possible to opt for a "mixed" surface made up of pavers of different colours. It is also possible to play with alternations, random or not, between the patinated faces and those not patinated.

→ **Condition.** In addition to traces of mortar and paint residues, reclaimed clay pavers may show minor alterations such as signs of surface wear, chips, craters, light flaking, stains, traces of paint, leftover moss, etc. These deteriorations can influence the technical and aesthetic performance of the pavers, as well as their re-installation, but do not constitute a major obstacle to reclamation (see § "Characteristics and fitness for use"). The designer/specifier should define the degree of imperfections tolerated with regard to the intended use and the laying conditions.

**Design tip!**

To increase the chances of meeting the offer available on the reclamation market, the designer/specifier can choose to split large surfaces into smaller quantity batches (for example, by providing different setting and patterns on the surface to be paved).

→ **Quantity:** Some suppliers may include surplus when the product is delivered if they are not able to guarantee the absolute uniformity of the characteristics mentioned above. This surplus can also be applied in the case of an on-site salvage scenario. To limit the risk of not finding the model, special attention should be paid to the quantities ordered. It is generally advisable to provide a reserve stock of pavers in order to carry out subsequent repairs.

Most professional suppliers are able to ensure that delivered batches meet these requirements. Most of the reclaimed building materials are sold as is. The conditions of sale may however contain special guarantees specific to the material. Some suppliers are able to indicate the origin of the material and/or provide documentation on the product purchased (for more information, see the introductory sheet).



Renovation of pavement with reclaimed clay pavers, Bergen (NL), 2020 © Stone Base

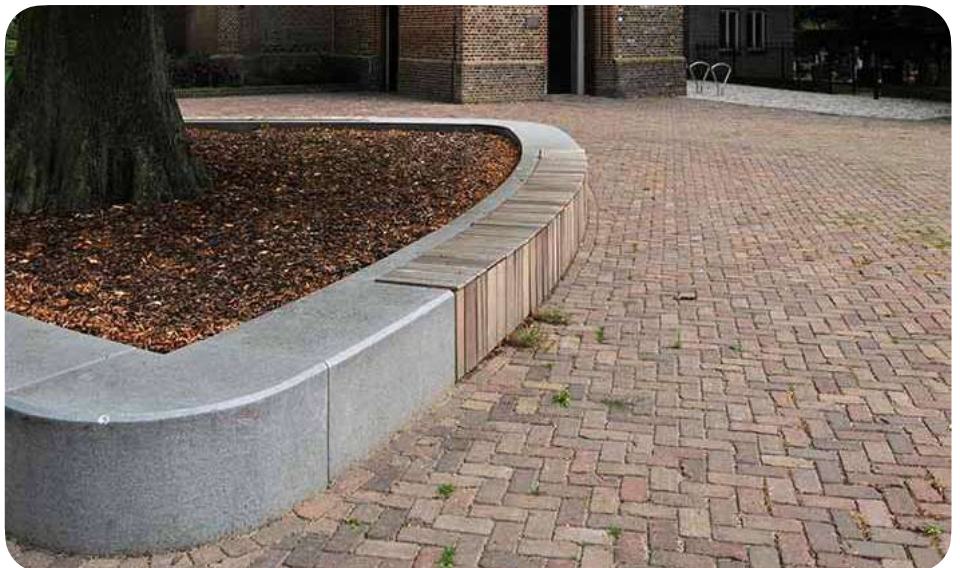

Designing a square with reclaimed clay pavers, Macharen (NL), 2020 © Stone Base



Designing a square with reclaimed clay pavers, Schijndel (NL), 2020 © Stone Base





**Characteristics and fitness for use**

The harmonised European standard EN 1344 establishes the relevant characteristics (according to the context) in order to determine the fitness for use of new clay pavers intended for indoor or outdoor use. Although detailed for new materials these characteristics may prove useful in considering the specific case of reclaimed pavers. Technical documentation from the original manufacturer, if available, can provide valuable information on material properties. Note that additional requirements are sometimes applicable on a national level.

*Tip!*

If the performance is to be determined in the laboratory, a representative sample of the batch in question should be established. The number and dimensions of the samples to be taken depend on the type of test to be carried out. In order for the test results to be usable, the sampling procedure must be rigorous. A professional can assist you in this work to choose the samples and the tests to be carried out. The test procedures will be defined with regard to the previous and subsequent uses of the pavers.

Characteristics	Comments
<b>Dimensions (length, width, thickness)</b>	<p>These characteristics are closely linked to the degree of wear of the pavers and the sorting quality. A visual or detailed examination of the batch is often sufficient to estimate them. The EN 1344 standard recommends that the tolerable deviation from the nominal dimensions cannot exceed <math>0,4 \sqrt{d}</math> (where <math>d</math> corresponds to the manufacturing dimension. By extension, in the case of reuse, <math>d</math> can correspond to the average dimension of the batch) .</p> <p>In practice, the dimensional variations and the deviation from the mean can be estimated based on a sample of pavers placed end to end according to the dimension to be evaluated. Typically, newer, properly sorted paver batches will meet the dimensional requirements of most applications. For batches of old pavers, it is advisable to determine with the supplier the acceptable dimensional tolerance, depending on the application and the method of laying (see the box "Mechanical laying!").</p>
<b>Density</b>	<p>The density of clay pavers is generally greater than 1,700 kg/m<sup>3</sup>. This can be estimated simply by using scales and a measure, or it can be determined with precision in the laboratory.</p>
<b>Porosity and water absorption</b>	<p>Given their high density, the porosity of clay pavers is generally low enough to ensure that they are waterproof. This characteristic changes little over time and batches of old pavers generally maintain good properties in this regard. However, special attention should be paid to the condition of the pavers (see § "Material reclamation"). The precise assessment of porosity (or measurement of water absorption) can also be accurately determined through laboratory tests.</p>
<b>Resistance to freezing/thawing (and de-icing salts)</b>	<p>The source and condition of a batch of clay pavers can provide a useful guide to determining their resistance to freezing/thawing. The pavers in good condition that have been dismantled in an area subject to strong freeze/thaw cycles are likely to show good frost resistance. If there are any doubts, laboratory tests can confirm this. The same goes for resistance to de-icing salt.</p>
<b>Transverse rupture strength</b>	<p>This characteristic indicates the ability of the material to withstand loads. Loads can vary greatly depending on the application (e.g. static vs dynamic, pedestrian zone vs. carriageway). The transverse rupture strength depends on the thickness of the pavers. It is commonly accepted that pavers should be 80 mm thick or greater for heavily trafficked pavements. The use and type of stress therefore establish the required thickness and, by extension, the laying method. Some clay pavers can be laid in several directions, for example flat and on their edge. In practice, pavers with a height of less than 40 mm are laid on a bed of stabilized sand or a mortar bed, and not on a bed of loose sand. For pavers laid on a loose bed, the proportion between length and height must not be greater than 6 mm.</p> <p>Information on the original road system sometimes makes it possible to assess this characteristic (i.e. pavers in good condition coming from a street subjected to intensive traffic by heavy vehicles testify in a certain way to their good mechanical resistance). If necessary, a laboratory three-point bending test can provide an accurate measurement of the mechanical strength of the pavers.</p>



Characteristics	Comments
<b>Wear resistance</b>	This feature concerns the visible faces. An assessment of the wear conditions of the original road system (e.g. service duration, traffic density, etc.) coupled with a measurement of the dimensions of the pavers generally allow the wear of the material to be assessed. If necessary, the precise assessment of wear resistance can also be determined precisely through laboratory tests.
<b>Slip resistance (and skid resistance)</b>	<p>This feature influences the comfort and safety of users. It is determined by the texture of the pavers, their degree of wear and the characteristics of the joints (e.g. density, thickness, etc.). It may change over time under the influence of wear, the slope, the density of the joints and the climatic context (rain-fall).</p> <p>In general, reclaimed clay pavers with a rough appearance have sufficient slip resistance. In addition, during laying, the pavers may be slightly abraded by the grouting process. The in-depth assessment (by laboratory testing) of slip resistance is relevant when the work is intended for pedestrians and the skid resistance when the structure is intended for vehicular traffic.</p>
<b>Fire resistance and performance</b>	The nature and composition of the material satisfy the reaction to fire class A1 according to standard EN 13501-1. It is not necessary to check this requirement if the pavers do not contain more than 1% organic matter by mass (which is almost always the case due to the baking process) and if no protective coating is applied to the pavers.

### Hazardous substances and precautions

→ **Leaching**. In 2017, the city of Amsterdam commissioned a study on the leaching of clay pavers around its area. It appears that no unacceptable form of leaching was observed in the materials studied. The report concludes that as long as they are not contaminated from the outside, from a health and environmental point of view, all clay pavers present in their area and all pavers comparable in age, type and composition, can be reused.

→ **Oil contamination on the surface**. The city of Amsterdam also specifies that limited contamination of the surface by oil is acceptable (max 0.5 m<sup>2</sup> / soiled area). Other types of surface contamination are not allowed, regardless of the surface.

→ **Asbestos and tar**. Foundations contaminated with asbestos or tar can contaminate clay pavers.

### Références

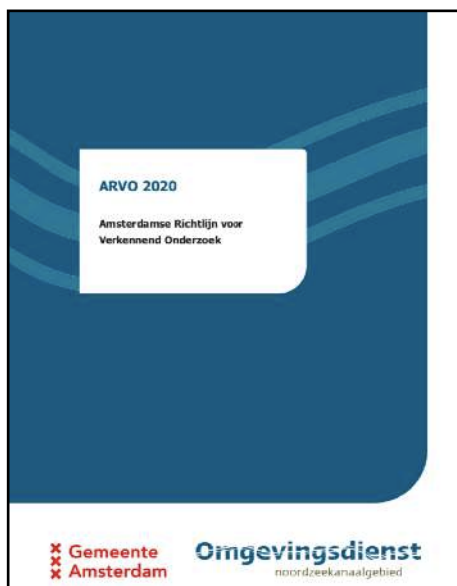

Environment Department of the North Sea Channel Region, "Making a contribution. A guide for the reuse of road materials in the municipality of Amsterdam", 29 March 2018. (in Dutch).  
[https://assets.amsterdam.nl/publish/pages/909255/gams2020049\\_arvo\\_rapport\\_r1.pdf](https://assets.amsterdam.nl/publish/pages/909255/gams2020049_arvo_rapport_r1.pdf)



"Reclamation rate of clay pavers in the Netherlands". Summary of the final report of the Royal Dutch Brick Manufacturers Association, 2009. (in Dutch).  
<https://www.knb-keramiek.nl/media/2264/9v1632-samenvatting-eindrapport-30nov.pdf>





**Availability**

The professional market for reclaimed clay pavers is fairly developed. The quantities available may vary depending on the target audience of professional suppliers (individuals or municipalities).

As an indication, for batches of the same model of reclaimed clay pavers:

Frequent	< 100 m <sup>2</sup>
Occasional	100 → 500 m <sup>2</sup>
Rare	> 500 m <sup>2</sup>

**Find specialised businesses**



**Indicative prices (Excl. tax)**

Random sampling of the reclamation market in Western Europe (Belgium, France, Great Britain and the Netherlands) made it possible to extract some indicative prices. These vary depending on the availability of the size and type of paver, as well as the degree of sorting. A sorted paver is often more expensive than an unsorted paver but is easier to place.

- *Waal format: 20 - 60 €/m<sup>2</sup>*
- *Thick format: 20 - 40 €/m<sup>2</sup>*
- *Pebble format: 20 - 35 €/m<sup>2</sup>*
- *Rijntjes format: 35 - 60 €/m<sup>2</sup>*
- *Ijseltjes format: 60 - 120 €/m<sup>2</sup>*

More pieces of small pavers are required to cover the same area. In addition, the laying cost will also be higher.



Automated cleaning and packaging process for reclaimed clay pavers. © NH Nieuws, 2018 (<https://www.youtube.com/watch?v=lmeWIMkRwoU>)

**Embodied carbon (Cradle to gate - production A1-A3)**

	kg CO <sub>2</sub> eq./m <sup>2</sup>	kg CO <sub>2</sub> eq./kg
OEKOBAUDAT database (DE) - Average dataset - Facing Bricks, Clay Pavers and Brick Slips *	26.1	255.5
NIBE database (NL) - Clay street pavers, thick format, lifespan 75 years *	52.6	515.7

\* Indicative values for 60 mm thick pavers with a density of 1700 kg/m<sup>3</sup>.



According to the sources, reusing 100 m<sup>2</sup> of reclaimed clay pavers prevents the production of ~ 2.610 to ~ 5260 kg of CO<sub>2</sub> equivalent related to the manufacture of new pavers (production phase only). This corresponds to the amount of emissions caused by a small diesel car travelling a distance of ~ 15.600 to ~ 31.500 km.

**Disclaimer**

This sheet is intended for designers, specifiers and other members of construction project teams wishing to reuse this building material or product. It is part of a collection of sheets aimed at bringing together the available information to date that is likely to facilitate the reuse of building materials and products.

This sheet has been produced by Rotor vzw/asbl within the framework of the Interreg FCRBE project - Facilitating the Circulation of Reclaimed Building Elements, supported by the entire project partnership. Sources of information include the experience of reclamation dealers and involved project partners, lessons learned from exemplary projects, available technical documentation, etc.

The sheets have been produced between 2019 and 2021. As the reclamation sector is evolving, some information, notably regarding pricing and availability, may change over the time. When the text refers to European standards, it is up to the project team to refer, if necessary, to their national implementations and local specificities.

It is important to note that the information presented here is not exhaustive or intended to replace the expertise of professionals. Specific questions are always project related and should be treated as such.

The complete collection of sheets (including the introductory sheet) is freely available from different reference websites (a.o. [opalis.eu](http://opalis.eu), [nweurope.eu/fcrbe](http://nweurope.eu/fcrbe), [futureuse.co.uk](http://futureuse.co.uk)).

Non-exhaustive directories of dealers in reclaimed building materials are available on [www.opalis.eu](http://www.opalis.eu) and [www.salvoweb.com](http://www.salvoweb.com).

---

Interreg FCRBE partnership: Bellastock (FR), the Belgian Building Research Institute / BBRI (BE), Brussels Environment (BE), the Scientific and Technical Center of Building / CSTB (FR), Confederation of Construction (BE), Rotor (BE), Salvo (UK) and University of Brighton (UK).

The information contained in this document does not necessarily reflect the position of all the FCRBE project partners nor that of the funding authorities.

Unless explicitly stated otherwise, the content of these sheets is credited in the Creative Commons Attribution NonCommercial – Share Alike format (CCBY-NC-SA).



Unless explicitly stated, the images used in this document belong to © Rotor vzw/asbl or © Opalis. Any other image has been the subject of a systematic request for authorisation from their authors or rightful owners. When this request has not been answered, we assumed that there were no objections to the use of the image. If you feel that this interpretation is unreasonable, please let us know.





### Material Description

'Steenschotten' type timber formwork panels are a true classic on the reclaimed market in Belgium and the Netherlands and, to a lesser extent, in France and Germany. These panels find their first application in the concrete industry where they are used as supports to vibrate and dry precast concrete products (blocks, pavers, curbs, etc.).

These are square or rectangular panels made up of wooden planks interlocked with each other by a tongue-and-groove assembly along the entire length. Planks are often held together by threaded rods across the width of the panel, and the ends are protected and reinforced across the width by metal C-channels (galvanised). Other assembly systems may also exist.

Their water repellency and altered appearance are caused by the impregnation of water and cement on the surface, the heat emitted during drying, friction with moulds and concrete blocks, and the use of form release oil.

Three main wood species are found on the current reclaimed market: azobé (*Lophira alata*, hardwood), Douglas fir (*Pseudotsuga menziesii*, softwood, also called Oregon pine) and larch (*Larix sp.*, softwood). Maritime pine (*Pinus pinaster*) panels are sometimes available. These variants differ in appearance (shade, texture, etc.) and properties (density, durability class, etc.). Raw panels generally have a rough, woolly texture which reflects their original use.

The dimensions of the panels are variable and in the order of [100 to 150] cm × [50 to 70/90 to 150] cm. Their thickness varies from 3 to 6 cm.

Their use in panel form is widespread for exterior applications such as patio floors, fences, palisades, wooden shelters, outdoor furniture, retaining walls, etc. The boards can also be dismantled and used for other applications (e.g. façade cladding). They are occasionally found in interior use as flooring or panelling.



Reuse of "steenschotten" in flooring and terrace floors. Brasserie de la Senne. Brussels (BE). Archi : La Générale  
© François Lichtlé.



### Material reclamation

The panels are mainly available from specialist dealers and can sometimes supplement the offer of new wood dealers.

The involvement of specialised professionals ensures the smooth running of the following operations:

- **Treatment:** the panels are generally resold in the raw state, without treatment. In some cases, or on demand, they can be sanded, sandblasted or washed with a high pressure cleaner. Some dealers offer to take the panels apart and resell them as individual planks at a higher cost.
- **Storage:** the panels are stored horizontally and stacked on pallets, usually outdoors. Depending on climatic conditions and the type of wood, the panels can become loaded with humidity, which significantly increases their specific weight.
- **Transport and delivery:** little or no difficulty. The specific weight of the panels (up to 120 kg for some azobé panels) must be taken into account during handling and transport.

#### Did you know?

The 'steenschotten' type wooden formwork panel is one of the few reclaimed building materials coming directly from the industrial production sector. On average, the service life of Douglas fir panels by the concrete industry is 3 to 5 years, that of azobé panels is 8 to 10 years.

The nomenclature of 'steenschotten' type formwork panels in wood is not fixed. They are sometimes found under the name 'shuttering panels', wooden cinder block drying boards, 'boat deck', etc.

Reclaimed 'steenschotten' type panels hardly ever benefit from a wood label (e.g.: FSC, PEFC, etc.). Their origin and their manufacturing conditions are rarely certifiable. The ecological impact of their use is difficult to quantify and should certainly not be considered as zero or low.



Panels before treatment



Cleaned and sorted panels



Exterior storage on pallets





## Applications and Installation

Reclaimed steenschotten wood panels are suitable for various applications, both indoors and outdoors.

### Outdoor use:

- **Flooring and terrace floors:** placing the panels is relatively simple and similar to that of other wooden decks. The panels can be fixed to a wooden structure (boards and joists) allowing ventilation from below (air space). Other systems (posts, studs, etc.) are also used. Fixing with stainless steel screws is recommended in order to avoid persistent rust discolouration of the wood. A preservative treatment (fungicide/insecticide) is recommended for Douglas fir and larch panels in order to prolong their longevity. It is advisable to protect the edges of panels subjected to heavy traffic.
- **Palisades, fences, cladding, outdoor furniture, retaining walls, etc.:** refer to table 2.

### Indoor use:

- **Flooring and panelling:** for interior applications, it is necessary to dry panels that have been stored outdoors before placing them (up to a moisture content of 8-12%). During drying, the wood tends to contract and the placement of dry panels will ensure better dimensional stability and avoid the appearance of cracks. It is recommended to consult a professional for drying.

Sanding of a panel floor covering of the 'steenschotten' type is generally carried out after installation by means of several passes with a rotary parquet sander and with abrasive discs of suitable grain size. The use of a belt sander is generally prohibited because of the grains of concrete present in the structure of the wood. In order to limit the presence of concrete residues, it is best to clean the panels using a high pressure cleaner before sanding.

The panels can be sanded, sandblasted, brushed, burnt ('shou sugi ban'), oiled, varnished, stained or painted.

It is preferable to avoid cutting the panels due to the presence of the metal C-profiles and the fixing rods. If necessary, it is recommended to cut the panels parallel to the metal C-profiles at the ends. Azobé is a hard wood and requires suitable tools.

For all uses, in order to facilitate installation, the designer/specifier will take care to use batches with a certain degree of uniformity in terms of the following characteristics. Most professional suppliers are normally able to ensure that delivered batches meet these requirements.

- **Batch composition:** the batch must consist of panels made with the same type of wood.
- **Dimensions:** the dimensions of the panels must be uniform, including their thickness.
- **Colour:** relative uniformity, slight variations in colour are possible within the same batch.
- **Toxicity:** the absence of mineral formwork oil (black and toxic) from the original use of the panels must be guaranteed for interior applications or in direct contact with the skin.
- **Condition:** Panels must be free from mould. The degree of wear and traces of use can vary greatly from batch to batch. Some dealers make a distinction between first and second choice panels. In the latter category, we often find panels with slight damage such as broken or missing metal profiles, cracks and pitting in the wood, exploded surfaces, non-straight edges, rounded corners, etc.

It is up to the designer/specifier to define the degree of imperfection tolerated, with regard to the intended use and any restoration work, by specifying the acceptance or rejection of the defects. For example, cracked panels are unlikely to be suitable for a heavily loaded flooring application, just as panels with rounded corners will affect the aesthetic appearance of a patio floor.

Most of the reclaimed building materials are sold as is. The conditions of sale may however contain specific guarantees specific to the material. Some suppliers are able to indicate the origin of the material and/or provide documentation on the product purchased (*for more information, see introductory sheet*).

It is important to purchase a sufficient quantity of panels from the outset. Resellers usually have panels whose format is linked to a specific batch. It is therefore uncertain that the desired format will still be available in a subsequent order.

### Find specialised businesses



[salvoweb.com](http://salvoweb.com)

[opalis.eu](http://opalis.eu)





**Characteristics and fitness for use**

In the particular case of 'steenschotten' type wooden formwork panels, there are no standards allowing their specific performance to be determined as a construction element. However, experience as well as normative and technical documents relating to wood and new wood-based materials sold make it possible to highlight the following characteristics and recommendations:

*Table 1: Technical characteristics of the 3 main types of wood used in the panels*

	Azobé <i>Lophira alata</i>	Douglas <i>Pseudotsuga menziesii</i>	Mélèze <i>Larix sp.</i>
<b>Density [kg/m3]</b>	1050	550	600
<b>Monnin / Janka hardness – Sinking resistance *</b>	10,7 / 17000 N (hard)	3,2 / 2940 N (medium-hard)	3,8 3400 N (medium-hard)
<b>Stability in use</b>	Low	Medium	Medium
<b>Natural durability (resistance to wood-eating fungi)**</b>	Class I-II (durable to highly durable)	Class III (weak to moderately durable)	Class III (weak to moderately durable)
<b>Durability against xylophagous insects**</b>	(Durable against termites)	Durable	Durable
<b>Colour (shade)</b>	Reddish-greyish	Orangish-greyish	Yellowish-greyish

\* There are various methods for determining the hardness of wood, with different test arrangements (Monnin, Janka, Brinnell). The values below, taken from different sources, are given as an indication. They show the transversal sinking resistance at 12% moisture content.

\*\* This classification is only valid for heartwood and not sapwood (peripheral wood). We are taking into consideration here that 'steenschotten' shuttering panels are produced

*Table 2: Classes of use of wood and the associated biological risks*

Usage class	General use	Biological risks		Natural durability class of wood				
		Insects	Fungi	I	II	III	IV	V
				Azobé		Douglas / Larch		
1	Indoors, in the dry	Yes	No					
2	Indoors, or under shelter, not exposed to bad weather. Possibility of water condensation	Yes	Low					
3	Outside, above ground, exposed to bad weather	Yes	Yes					
4	Outside in contact with the ground and/or fresh water	Yes	Yes					
5	Immersed in salt water on a regular or permanent basis	Yes	Yes					

Treatment not Required  
Recommended Treatment  
Treatment Needed

The performance of wood in use is essentially determined by the following parameters: durability class of the wood (resistance to fungi and insects), water permeability and the presence of humidity in its immediate environment. The harmonised European standard EN 460 thus defines five classes of use of wood and the associated biological risks, and recommends the possible application of an adequate protective treatment according to the use and the class of natural durability of the wood used (see table 2).

*N.B.: the durability and water permeability of 'steenschotten' type panels is already influenced by their primary use and their impregnation with cement and release oils.*

In general, azobé panels are recommended for exterior floor applications exposed to bad weather (terraces) without preservative treatment. This tropical hardwood is stronger, more resistant to compression and humidity than coniferous species (Douglas fir/larch), which increases its longevity in use. However, panels based on coniferous species can also be recommended on condition that an adequate preservative treatment is applied with more frequent maintenance.

*For other interior and exterior applications, the three species can be used in accordance with the recommendations in table 2.*





**Other relevant characteristics to be assessed according to use and context**

Characteristics	Comments
<b>Dimensions (length, width, thickness)</b>	These characteristics are closely linked to the degree of sorting of the panels. A visual or detailed examination of the batch is often sufficient to estimate it.
<b>Geometry (straightness of edges, angularity, flatness of the surface)</b>	These characteristics are closely linked to the degree of sorting of the panels. A visual or detailed examination of the batch is often sufficient to estimate it.
<b>Surface and edge quality</b>	These characteristics are closely linked to the degree of sorting of the panels. A visual or detailed examination of the batch is often sufficient to estimate it. The quality of the surface must anticipate the desired degree of finish (raw, sanded, sandblasted, brushed, burnt, etc.).
<b>Water absorption</b>	The water absorption properties of 'steenschotten' type panels are difficult to measure and are probably reduced to their original use (impregnation with cement and release oils would improve the water repellency of the product). The application of preservative/finish will also influence this parameter.
<b>Mechanical performance</b>	The in-depth evaluation of mechanical performance is relevant in case of high static and/or dynamic loads.
<b>Wear</b>	Azobé panels have a higher risk of splitting. Tropical wood splinters usually contain chemicals that increase pain in case of injury. It is therefore recommended to sand them so that they can be used barefoot as a floor covering.
<b>Safety</b>	Panels with rusty profiles (which is quite common) and which may come into direct contact with the skin should be treated appropriately. Some panels have stainless steel profiles, but they are rather rare.
<b>Slippage</b>	The type of finish (sanded, brushed, raw) affects this parameter and influences the appearance of algae in a humid environment. The presence of algae on the panels must be controlled by frequent cleaning and/or suitable preventive treatment.
<b>Reaction to fire</b>	<p>Specific requirements for the reaction to fire of coatings are determined by national regulations. These requirements depend, among other things, on the use of the premises (for example: private or community housing, emergency exits, terraces on flat roofs, etc.), on the height of the building (for façade cladding) but also on the ability of users to evacuate the premises in the event of fire (senior citizens' residence, hospital, etc.).</p> <p>The reaction to fire of construction products is defined by European standard EN 13-501-1 (Euro-class) and is assessed in particular on the basis of a test carried out under the final application conditions, i.e. taking into account the entire construction system. According to the European classification, solid wood panels (minimum density 400 kg/m<sup>3</sup>, minimum thickness 12 mm) are classified Dfl-s1 for floor applications and D-s2, d0 for other applications (without an air gap behind the wood panel).</p> <p>It is therefore important for the designer/specifier to meet regulatory requirements in terms of reaction to fire by determining the materials and their method of implementation, with regard to the intended use.</p> <p>With regard to 'steenschotten' type panels, fire retardant treatments improve reaction to fire and reduce their contribution to the conflagration and the spread of the fire.</p>
<b>Toxicity</b>	During their first use, the use of form release oils on the surface of the panels is frequent and their impact in terms of toxicity is sometimes uncertain. A distinction is made between mineral oils (black), which are harmful to health and the environment, and vegetable oils (white), without noticeable toxicity. In the absence of information on this subject, it is best to stick to the 'precautionary principle' for interior applications.



Assessing the global warming impact of reclaimed wood construction products is complex and difficult to generalise. The analysis is specific to the product concerned, and involves parameters such as the origin of the product, the environmental performance of the new equivalent, the working life, the quantity of biogenic carbon stored in the material, etc. The analysis is also specific to the product itself. For more information, it is advisable to consult the specific paragraph dedicated to this issue in Fiche introductive.

**Availability**

'Steenschotten' type timber formwork panels are a relatively common product on the reclamation market. However, availability depends on the quantities required. As an example:

Frequent	Batch from 0 to 500 m <sup>2</sup>
Ocasional	Batch from 500 to 1000 m <sup>2</sup>
Rare	Batch > 2000 m <sup>2</sup>

In recent years, the new production of azobé panels has fallen sharply in favour of panels in Douglas-fir/larch/maritime pine or in composite materials, as a result of which their price has risen sharply. This is due to the stricter deforestation rules that currently apply in tropical regions where this species of wood is exploited. Similarly, new technologies allow used panels to be honed in order to extend the life of their primary use. The market for 'steenschotten' - reclaimed panels is probably likely to shrink over the next decade.

**Indicative prices (first choice, excl. tax)**

A non-exhaustive sample of the Western European reclaim market (Belgium, France, UK, and the Netherlands) has allowed us to extract some indicative prices:

→ Douglas 140 × 110 × 5 cm: 15 to 25 €/m<sup>2</sup>

→ Azobé 140 × 110 × 4.5 cm: 35 to 45 €/m<sup>2</sup>

**Hazardous substances and precautions**

During their first use, the use of form release oils on the surface of the panels is frequent and their impact in terms of toxicity is sometimes uncertain. A distinction is made between mineral oils (black), which are harmful to health and the environment, and vegetable oils (white), without noticeable toxicity. In the absence of information on this subject, it is best to stick to the 'precautionary principle' for interior applications.



Examples of reused steenschotten  
© [panneauxleontine.be](http://panneauxleontine.be)



Examples of reused steenschotten  
© [panneauxleontine.be](http://panneauxleontine.be)



Examples of reused steenschotten  
© [panneauxleontine.be](http://panneauxleontine.be)

**Disclaimer**

This sheet is intended for designers, specifiers and other members of construction project teams wishing to reuse this building material or product. It is part of a collection of sheets aimed at bringing together the available information to date that is likely to facilitate the reuse of building materials and products.

This sheet has been produced by Rotor vzw/asbl within the framework of the Interreg FCRBE project - Facilitating the Circulation of Reclaimed Building Elements, supported by the entire project partnership. Sources of information include the experience of reclamation dealers and involved project partners, lessons learned from exemplary projects, available technical documentation, etc.

The sheets have been produced between 2019 and 2021. As the reclamation sector is evolving, some information, notably regarding pricing and availability, may change over the time. When the text refers to European standards, it is up to the project team to refer, if necessary, to their national implementations and local specificities.

It is important to note that the information presented here is not exhaustive or intended to replace the expertise of professionals. Specific questions are always project related and should be treated as such.

The complete collection of sheets (including the introductory sheet) is freely available from different reference websites (a.o. [opalis.eu](http://opalis.eu), [nweurope.eu/fcrbe](http://nweurope.eu/fcrbe), [futureuse.co.uk](http://futureuse.co.uk)).

Non-exhaustive directories of dealers in reclaimed building materials are available on [www.opalis.eu](http://www.opalis.eu) and [www.salvoweb.com](http://www.salvoweb.com).

---

Interreg FCRBE partnership: Bellastock (FR), the Belgian Building Research Institute / BBRI (BE), Brussels Environment (BE), the Scientific and Technical Center of Building / CSTB (FR), Confederation of Construction (BE), Rotor (BE), Salvo (UK) and University of Brighton (UK).

The information contained in this document does not necessarily reflect the position of all the FCRBE project partners nor that of the funding authorities.

Unless explicitly stated otherwise, the content of these sheets is credited in the Creative Commons Attribution NonCommercial – Share Alike format (CCBY-NC-SA).



Unless explicitly stated, the images used in this document belong to © Rotor vzw/asbl or © Opalis. Any other image has been the subject of a systematic request for authorisation from their authors or rightful owners. When this request has not been answered, we assumed that there were no objections to the use of the image. If you feel that this interpretation is unreasonable, please let us know.





### Material Description

Ship's timber (in Dutch: 'scheepsplanken', 'scheepsvloer' or 'scheepshout') is a salvaged material found mainly in Belgium and the Netherlands. It comes from the dismantling of port and maritime structures such as pontoons or barge holds.



Appearance of ship's timber

The wood species concerned is almost exclusively azobé (*Lophira alata*), which is a tropical hardwood that is naturally resistant to moisture and has high mechanical properties.

The boards sold have generally been influenced by time (bad weather, salt water, wear, etc.) and are characterised by a weathered appearance and a coarse texture.

Their dimensions are variable. In general, the boards are 10 to 23 cm wide, 2.5 to 5 cm thick and 80 cm to 5 m long. Slight differences in colour are perceptible between batches, or even within the same batch.

They are widely used for exterior applications such as patio floors, fences, palisades, wooden shelters, outdoor furniture, retaining walls, etc. They are occasionally found in interior use as flooring or panelling.



Outdoor storage © [scheepsplanken.be](https://scheepsplanken.be)

### Material reclamation

Ship's wood planks are available from specialist dealers and can sometimes supplement the offer of new wood dealers.

The involvement of specialised professionals ensures the smooth running of the following operations:

→ **Treatment:** boards are generally sold in the raw state or with a light surface treatment (brushing, sanding, sandblasting, high pressure cleaning). In some cases, they can be planed on 3 sides, without affecting the surface patina (upper side).

→ **Storage:** the planks are stored horizontally and stacked on pallets, usually outdoors.

→ **Transport and delivery:** little or no difficulty. The specific weight of azobé (1050 kg/m<sup>3</sup>) must be taken into account during handling and transport.



Brushed boards © [scheepsplanken.be](https://scheepsplanken.be)



Outdoor storage © [rawwood.be](https://rawwood.be)

**Applications and laying**

Reclaimed ship wood planks are suitable for a variety of applications, both indoors and outdoors.

**Outdoor use**

→ **Flooring and decking:** placing salvaged ship wood planks is relatively straightforward and comparable to new wood decks. The planks are generally fixed to a wooden structure (boards and joists) allowing ventilation from below (air space).

→ **Palisades, fences, cladding, outdoor furniture, retaining walls, etc.**

Fixing with stainless steel screws is recommended in order to avoid persistent rust discolouration of the wood. Due to the hardness of the material, it is also advisable to pre-drill it. The installation will be done in accordance with the state of the art and will take into account in particular the following focal points: condition and properties of the underlying structure, moisture of the wood, slenderness coefficient of the planks (width/thickness ratio), method of fixing, etc.

*Ship's wood planks have generally withstood many years of use and are generally less prone to deformations (sagging, warping, etc.) than their new wood counterparts.*



Untreated boards © [rawwood.be](http://rawwood.be)

**Indoor Use**

→ **Flooring and panelling:** for interior applications, it is necessary to dry planks that have been stored outdoors before placing them (up to a moisture content of 8-12%). During drying, the wood tends to contract and the placement of dry planks will ensure better dimensional stability and avoid the appearance of cracks. It is recommended to consult a professional for drying.

**Toxicity**

*Planks from barge holds may have come into contact with toxic mixtures. In the absence of information on this subject, it is best to stick to the 'precautionary principle' for interior applications and furniture.*

Ship's wood planks can be sawn, sanded, sandblasted, brushed, oiled, varnished or painted. Please note that azobé is a particularly hard wood which requires suitable tools.

For all uses, in order to facilitate installation, the designer/specifier will take care to use batches with a certain degree of uniformity in terms of the following characteristics. Most professional suppliers are normally able to ensure that delivered batches meet these requirements.

→ **Batch composition:** the batch must consist of planks of the same species of wood (azobé).

→ **Dimensions:** the dimensions of the planks must be uniform, especially in terms of thickness. It is also possible to opt for laying in free lengths, which places fewer demands on the lengths of the boards.

→ **Colour:** relative uniformity, variations in colour are possible within the same batch.

→ **Condition:** Planks must be free from mould. The degree of wear and traces of use can vary greatly from batch to batch.



Dismantling of barge holds  
© [historischhout.nl](http://historischhout.nl)

It is up to the designer/specifier to define the degree of imperfection tolerated, with regard to the intended use and any restoration work, by specifying the acceptance or rejection of the defects. For example, cracked planks are unlikely to be suitable for a heavily loaded flooring application.

Most of the reclaimed building materials are sold as is. The conditions of sale may however contain special guarantees specific to the material. Some suppliers are able to indicate the origin of the material and/or provide documentation on the product purchased (for more information, see the introductory sheet).

It is important to purchase a sufficient quantity of panels from the outset. Resellers usually have panels whose format is linked to a specific batch. It is therefore not certain that the desired format will still be available in a subsequent order.



**Characteristics and fitness for use**

In the particular case of wooden ship planks, there are no standards to determine their specific performance as a construction element. However, experience as well as normative and technical documents relating to wood and new wood-based materials make it possible to highlight the following characteristics and recommendations:

Table 1: Technical characteristics of azobé (*Lophira alata*)

Density [kg/m3]	1050
Monnin / Janka hardness - Sinking resistance *	10,7 / 17000 N (hard)
Stability in use	Low
Natural durability (resistance to wood-eating fungi) **	Class I-II (durable to highly durable)
Durability against xylophagous insects **	(Durable against termites)
Colour (shade)	Reddish-greyish

\* There are various methods for determining the hardness of wood, with different test arrangements (Monnin, Janka, Brinnell). The values below, taken from different sources, are given as an indication. They show the transversal sinking resistance at 12% moisture content.

\*\* This classification is only valid for heartwood and not sapwood (peripheral wood). We are taking into consideration here that ship's wood planks are only made of heartwood to meet the technical needs of port and maritime applications.

The performance of wood in use is essentially determined by the following parameters: durability class of the wood (resistance to fungi and insects), water permeability and the presence of humidity in its immediate environment. The harmonised European standard EN 460 thus defines five classes of use of wood and the associated biological risks, and recommends the possible application of an adequate protective treatment according to the use and the class of natural durability of the wood used (see table 2).

In general, azobé planks are recommended for exterior floor applications exposed to bad weather (terraces) without preservative treatment (usage class 3). This tropical hardwood is strong and resistant to compression and moisture, which increases its longevity in use.

Table 2: Classes of use and associated biological risks

Usage class	General use	Biological risks		Natural durability class of wood				
		Insects	Fungi	I	II	III	IV	V
				Azobé				
1	Indoors, in the dry	Yes	No					
2	Indoors, or under shelter, not exposed to bad weather. Possibility of water condensation	Yes	Low					
3	Outside, above ground, exposed to bad weather	Yes	Yes					
4	Outside in contact with the ground and/or fresh water	Yes	Yes					
5	Immersed in salt water on a regular or permanent basis	Yes	Yes					

Treatment not necessary  
Treatment is recommended  
Treatment is necessary





**Other relevant characteristics to be assessed according to use and context**

Characteristics	Comments
<b>Dimensions (length, width, thickness)</b>	These characteristics are closely linked to the degree of sorting of the planks and their origin. A visual or detailed examination of the batch is often sufficient to estimate it.
<b>Geometry (straightness of edges, angularity, flatness of the surface)</b>	These characteristics are closely linked to the degree of sorting of the planks and their origin. A visual or detailed examination of the batch is often sufficient to estimate it.
<b>Surface and edge quality</b>	A visual or detailed examination of the batch is often sufficient to estimate it. The quality of the surface must anticipate the desired degree of finish (rough, sanded, sandblasted, brushed, etc.).
<b>Water absorption</b>	Azobé boards are not very absorbent.
<b>Mechanical performance</b>	The in-depth evaluation of mechanical performance is relevant in case of high static and/or dynamic loads.
<b>Wear</b>	Azobé planks have a higher risk of splitting. Tropical wood splinters usually contain chemicals that increase pain in case of injury. It is therefore recommended to sand them so that they can be used barefoot as a floor covering.
<b>Slippage</b>	The type of finish (sanded, brushed, raw) affects this parameter and influences the appearance of algae in a humid environment. The presence of algae on the panels must be controlled by frequent cleaning and/or suitable preventive treatment.
<b>Reaction to fire</b>	<p>Specific requirements for the reaction to fire of coatings are determined by national regulations. These requirements depend, among other things, on the use of the premises (for example: private or community housing, emergency exits, terraces on flat roofs, etc.), on the height of the building (for the façade cladding) but also on the ability of users to evacuate the premises in the event of fire (senior citizens' residence, hospital, etc.).</p> <p>The reaction to fire of construction products is defined by European standard EN 13-501-1 (Euroclass) and is assessed in particular on the basis of a test carried out under the final application conditions, i.e. taking into account the entire construction system. According to the European classification, solid wood planks (minimum density 400 kg/m<sup>3</sup>, minimum thickness 12 mm) are classified Dfl-s1 for floor applications and D-s2, d0 for other applications (without an air gap behind the wood panel).</p> <p>It is therefore important for the designer/specifier to meet regulatory requirements in terms of reaction to fire by determining the materials and their method of implementation, with regard to the intended use.</p> <p>Regarding ship's wooden planks, fire retardant treatments improve reaction to fire and reduce their contribution to the conflagration and the spread of fire.</p>
<b>Toxicity</b>	Planks from barge holds may have come into contact with toxic mixtures. In the absence of information on this subject, it is best to stick to the 'precautionary principle' for interior applications.



Assessing the global warming impact of reclaimed wood construction products is complex and difficult to generalise. The analysis is specific to the product concerned, and involves parameters such as the origin of the product, the environmental performance of the new equivalent, the working life, the quantity of biogenic carbon stored in the material, etc. The analysis is also specific to the product itself. For more information, it is advisable to consult the specific paragraph dedicated to this issue in the introductory sheet.

**Availability**

Salvaged ship wood planks are mainly available in the Netherlands and Belgium. However, their availability depends on the quantities required. As an example:

Frequent	Batch from 0 to 50 m <sup>2</sup>
Ocasional	Batch from 50 to 150 m <sup>2</sup>
Rare	Batch > 150 m <sup>2</sup>

According to some specialist dealers, the supply of salvaged ship wood planks is compromised. They are gradually being replaced by metallic materials, which results in scarcity on the reclaimed market.

**Indicative prices (excl. tax)**

A non-exhaustive sample of the Western European reclaim market (Belgium, France, UK, and the Netherlands) has allowed us to extract some indicative prices:

→ *Sorted and brushed*: 25 to 45 €/m<sup>2</sup>

**Hazardous substances and precautions**

Planks from barge holds may have come into contact with toxic mixtures. In the absence of information on this subject, it is best to stick to the 'precautionary principle' for interior applications.

**Find specialised businesses**



[salvoweb.com](http://salvoweb.com)

[opalis.eu](http://opalis.eu)



Terrace application  
© [robuustbarnwood.nl](http://robuustbarnwood.nl)



Outdoor cladding  
© [rawwood.be](http://rawwood.be)



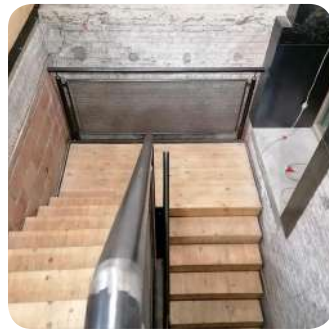

# STRUCTURE AND SHELL



- Solid structural timber with rectangular cross-section
- Glued laminated timber structural elements
- Steel beams
- Barnwood
- Solid clay brick
- Clay roof tile
- Roofing elements in natural slate
- Natural stone sill
- Natural stone wall copings
- Natural stone wall covering slab





**Disclaimer**

This sheet is intended for designers, specifiers and other members of construction project teams wishing to reuse this building material or product. It is part of a collection of sheets aimed at bringing together the available information to date that is likely to facilitate the reuse of building materials and products.

This sheet has been produced by Rotor vzw/asbl within the framework of the Interreg FCRBE project - Facilitating the Circulation of Reclaimed Building Elements, supported by the entire project partnership. Sources of information include the experience of reclamation dealers and involved project partners, lessons learned from exemplary projects, available technical documentation, etc.

The sheets have been produced between 2019 and 2021. As the reclamation sector is evolving, some information, notably regarding pricing and availability, may change over the time. When the text refers to European standards, it is up to the project team to refer, if necessary, to their national implementations and local specificities.

It is important to note that the information presented here is not exhaustive or intended to replace the expertise of professionals. Specific questions are always project related and should be treated as such.

The complete collection of sheets (including the introductory sheet) is freely available from different reference websites (a.o. [opalis.eu](http://opalis.eu), [nweurope.eu/fcrbe](http://nweurope.eu/fcrbe), [futureuse.co.uk](http://futureuse.co.uk)).

Non-exhaustive directories of dealers in reclaimed building materials are available on [www.opalis.eu](http://www.opalis.eu) and [www.salvoweb.com](http://www.salvoweb.com).

---

Interreg FCRBE partnership: Bellastock (FR), the Belgian Building Research Institute / BBRI (BE), Brussels Environment (BE), the Scientific and Technical Center of Building / CSTB (FR), Confederation of Construction (BE), Rotor (BE), Salvo (UK) and University of Brighton (UK).

The information contained in this document does not necessarily reflect the position of all the FCRBE project partners nor that of the funding authorities.

Unless explicitly stated otherwise, the content of these sheets is credited in the Creative Commons Attribution NonCommercial – Share Alike format (CCBY-NC-SA).



Unless explicitly stated, the images used in this document belong to © Rotor vzw/asbl or © Opalis. Any other image has been the subject of a systematic request for authorisation from their authors or rightful owners. When this request has not been answered, we assumed that there were no objections to the use of the image. If you feel that this interpretation is unreasonable, please let us know.



### Material description

**The term “structural timber” in fact covers a wide variety of elements, the characteristics of which vary according to the type of wood, the dimensions, the original assembly methods or even the presence of any finishing and preservation treatments.**

In this sheet, we are interested in the reclamation of solid structural timber elements with rectangular cross-section. These generally come from multiple sources: frames and floors, structural supports (columns-beams), framework, structural works of art, etc. This timber can be rough sawn, planed and marked by the imprints of time. A specific terminology - and sometimes tinged with regional terms - makes it possible to classify the elements according to their dimensions and/or their use. For example: beams, joists, rafters, planks, battens, etc.

The products commonly available on the reclamation market can be classified into two main categories:

→ **“Technical” timber.** these are timber sections sought after for their technical qualities. They are generally sold as a (greener and cheaper) alternative to new equivalents. Their dimensions sometimes correspond to the standards of new construction timber, but this is not systematic. However, they have a certain regularity. The species are mainly resinous: douglas-fir, spruce, pine, fir, larch, etc.

→ **Old beams.** these are sections that come from old buildings, often centuries old. Usually more expensive, they are sought in the first place for their history and their appearance (generally more irregular than the more recent standardized sections). There are old beams in hardwood (mainly oak) and softwood (fir, spruce, larch, ...).

This sheet does not apply to other timber structural elements: round timber, laminated timber, glued laminated timber, CLT, finger-jointed timber, multi-finger timber, etc.

Wooden elements can have a very long lifespan as evidenced by many examples of ancient constructions around the world: Asian temples, houses in the United States, half-timbered houses in Europe, etc. It is not uncommon for reclaimed elements to have already lived through several lives as wood is such a versatile material that lends itself to multiple uses.

Historically, this versatility has made wood a central material in the pre-industrial European economy, especially in construction. Wood was not just a building material in its own right, available for multiple uses, but it was also an essential component for the installation of other materials, such as stone. It was indeed used for the realization of ribs, formwork, cranes, scaffolding, etc. Numerous archaeological examples attest that it was common to completely dismantle and reassemble timber frame buildings such as barns and houses.

Despite their virtuous nature for the environment, these practices have become less common today in North-western Europe - by comparison, they are flourishing in the United States, no doubt due to a greater persistency in timber construction.

The assessment of the technical qualities of old structures is specific and generally requires a tailor-made approach. Under normal conditions, they are dry and sufficiently stable to limit the phenomena of torsion or shrinkage due to drying when they are reused in buildings. The old structures are often the object of great attention during the restoration of old buildings. Certain methods, used in this context to ensure the fitness for use of structural elements, can also be applied to the case of reclaimed timber.



Reclamation of structural beams  
© yr-architecture (USA)



Old oak beams



Softwood uprights used for their technical qualities



**Material reclamation**

**The reclamation of structural timber generally requires good coordination and must be done in compliance with the safety rules applicable to demolition work, in particular when such dismantling involves structural elements.**

→ *Preliminary studies.* these aim to assess the general quality of the various elements. They can combine several approaches:

- *Visual inspection.* This generally makes it possible to identify the species of wood and to identify the possible presence of the following aspects, which may limit or even compromise the potential for reclamation:
  - creep (deformation), an indicator of a high loading rate that can lead to a decrease in the mechanical properties of the elements
  - natural defects (knots)
  - sapwood
  - splits (oriented in the direction of the fibres) and cracks (cutting across the fibres)
  - visible fungi, biological agents, xylophagous insects
  - areas of mould, humidity, discolouration (generally located in front of damp rooms, at the level of gutters and in any place likely to have been in prolonged contact with moisture)
  - saw marks
  - oxidation of metal assemblies
  - etc.

This inspection also makes it possible to verify the straightness of the elements (local and global deformation) and to observe the nature of the assemblies, which can influence the dismantling method.

• *Basic tests:*

- “Hardness” test using a resistograph. It allows the detection of superficial areas of rot.
- “Screwdriver” test. Consists in causing a localised splinter using a blunt object. In healthy wood, the breakage occurs along the fibres while rotten wood tends to break in small pieces or in the middle of the fibres.

- “Mallet” test. Consists in gently striking the timber to detect the presence of empty or rotten areas (emitting a hollow sound).
- Humidity measurement using a moisture meter.
- *Additional Tests.* Additional studies can be carried out to establish a more complete diagnosis of the condition of the elements, in particular if they are painted or covered: auscultation by drilling and coring (making it possible to detect internal deterioration of the wood and, if necessary, to determine thickness of residual healthy wood), various laboratory tests to detect the presence of fungi, to precisely identify the species, to measure the density or to detect the presence of dangerous substances (see § “Hazardous substances and precautions”).

- *Complementary studies.* Depending on the new, targeted uses, other studies may be carried out:
  - building history, based on the original documentation (executive plans, assembly method, calculation notes, etc.) and research on the conditions of use (maintenance of long-term occupants, identification of events such as fires, water infiltration, flooding, etc.).
  - geometric profile, based on a survey of the frame or framework by a surveyor to mark the dimensions of the elements and their connections.



“Screwdriver” test  
© [qualite.bzh](http://qualite.bzh)



Mallet test  
© [Romane Lavoine](http://Romane Lavoine)



Hardness test using a resistograph  
© [qsb.fr](http://qsb.fr)



Wood moisture measurement using a moisture meter  
© [Romane Lavoine](http://Romane Lavoine)

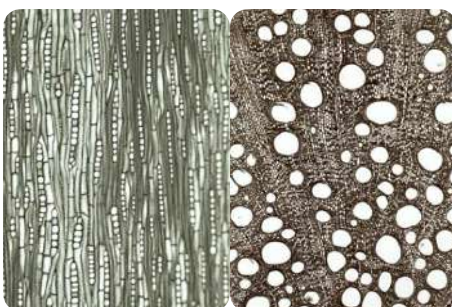

Laboratory analysis - optical microscopy technique, oak (*Quercus Petraea*) - tangential section (left) and transversal microcut (right) © [woodanatomy.ch](http://woodanatomy.ch)



Wood coring  
© [Romane Lavoine](http://Romane Lavoine)





→ **Removal.** the careful dismantling of the elements must ensure the safety of the workers and the integrity of the recovered elements. A percentage loss is generally admissible due to potential breakage and cuts. Similar elements are preferably grouped, numbered and correctly identified in order to guarantee the uniformity and traceability of the batches. They are stored on blocks (no contact with the ground), spaced apart and sheltered from bad weather.

→ **Operations.** depending on their condition, reclaimed timber structural elements may go through several operations before being re-installed. Most of the time, specialised suppliers automatically carry out some of these operations. However, sometimes the timber is salvaged or sold in its original condition. It is then up to the buyer to anticipate these stages.

- **Removal of metallic elements.** Nails, screws and other metal parts are removed using suitable tools (pincers, pneumatic nail punch, etc.). This laborious process is essential if woodworking is planned later, at the risk of damaging the machines. Using a metal detector makes it easier to locate metal objects.

- **Superficial cleaning.** By means of a soft or metal brush, by sanding or sandblasting according to requirements.

- **Drying.** According to the hygrometric state of the timber. The elements are generally dried naturally in a shed, taking the necessary storage arrangements (spacing between the elements, no contact with the ground, wedges, etc.). Artificial kiln drying can be used to reduce and stabilise the humidity level. Artificial drying also contributes to the elimination of potential pests (mould, insects).

- **Timber classification.** In order to ensure that the performance of reclaimed timber elements meet the requirements linked to their future use, their specific characteristics should be ascertained (*see § Characteristics and fitness for use*). This is particularly the case for structural uses, governed by a normative framework which requires knowing with sufficient precision the mechanical properties of timber. Each element can be inspected visually by a certified person or by machine to determine the species of wood, the type of wood, the durability class, the mechanical resistance class, the presence of preservative treatments and their influence on the durability, etc. Classification is preferably done when the elements have acquired their final section (for example, after planing). The items are then marked separately or in bundles.



Dismantling of the timber beams of the "Tour à Plomb", Brussels (BE). © BVDA - Bernard Van Damme Architecte



Removal of bark, sapwood and wood chips © yr-architecture



Removing metal parts



Timber cleaning © yr-architecture

### Truly Reclaimed Label

As part of the European FCRBE project, to which these sheets are attached, the organisation SALVO Ltd. (UK) is working on the development of a "Truly Reclaimed" label, making it possible to certify the authentically recovered origin of materials (as opposed to artificially used materials). This label should see the light of day very soon for reclaimed timber products.

### Timber classification

The harmonised standard EN 14081-1 defines the requirements for new rectangular structural timber classified by their resistance and their CE marking. It defines 2 timber grading methods:

1. **Machine grading** (standard EN 519): common in industrial installations, it enables production samples to be characterised from measurements obtained by approved grading machines. Grading differs according to the species (coniferous or deciduous). The mechanical properties of the elements are assessed using non-destructive tests (continuous 3-point bending test, X-ray, ultrasound, vibration, etc.). A preliminary visual check is necessary to deal with resistance characteristics that are not automatically detected by the machine. It is interesting to note that there are mobile grading machines. Under certain conditions, this application could prove to be useful if it is a question of grading a large batch of reclaimed structural timber. For information, the MTG portable grading machine costs between € 7,000 and € 15,000 depending on the settings and functions required.
2. **Visual method** (standard EN 518): this involves visually identifying the defects on the surface of the part which may lead to a decrease in resistance (dimension of the splits, density, number and size of knots, resin pockets, slope of grain, etc.), but also geometric defects over the entire part (waned (sapwood), longitudinal and transverse deformations, twisting, etc.) and potential biological attacks (fungi, insects, rot, etc.). Many different visual grading rules coexist in Europe, depending on the country, but basic principles have been established. In practice, approved certifiers are able to characterise new timber in order to justify its use as a structural element. A correspondence table of visual classes and mechanical classes is defined by standard EN 1912. This method may be applicable to reclaimed items.



- **Preservation treatment.** If the use requires it, it is possible to treat the timber elements, in order to optimise their durability outdoors and improve their class of use. Several types of preventive treatments exist, for example by soaking, sprinkling, brushing, autoclave, etc. They are governed by standards and use recommendations. Professional advice is recommended, especially if the timber has undergone this type of treatment before or if a topcoat is present. He will also be able to inform you about the possible toxicity of the products.

- **Heat treatment.** This process improves the durability of timber outdoors, but it affects the mechanical properties of the timber. It is more often used for cladding elements.

- **Sawing and cutting.** The timber can be reduced in section and length. Some resellers also offer cutting of structural members, the realisation of trusses or other structures by choosing the appropriate elements in their stock. Others cut old beams to make parquet, floorboards or cladding.

- **Planing.** The timber can also be left raw or planed on one or two sides to obtain flat and constant sections.

- **Finishes.** The timber can be left as it is or receive a finishing coat (varnish, waxes, oils, stains, paint, etc.)

→ **Storage.** Timber is preferably stored on blocks with spacing between each element. It can be stored away from bad weather or in a heated environment to control the moisture content. In certain regions where the climate is not very humid, the beams can be stored outside. They are also placed on large racks, spaced apart from each other.

→ **Transport and delivery.** The necessary precautions must be taken during transport and delivery (strapping, handling method, etc.).



Sorting and selecting beams © yr-architecture



Storage © Opalis / Les ateliers de saint Gaudent



Timber finishing treatment © yr-architecture



Storage © Opalis / Vieux bois des Alpes



Labelling of beams, visual or machine grading © yr-architecture



Storage © Opalis / Atelier de saint Cannat



Storage © Opalis / Europort BVBA



Storage © Opalis / Bloem





### Applications and laying

**The installation of reclaimed timber elements lends itself to the same diversity of design methods as new materials. They can be reused for structural purposes (traditional frames, framework, mezzanines, awnings, etc.) or for other uses (decorative beams, furniture wood, joinery timber, etc.). Some suppliers cut old beams to make parquet, floorboards or even cladding.**

For structural applications, prior involvement of the design office on stability is recommended as well as the control office. They will be able to propose approaches adapted to the elements identified, including adjusting the safety margins to the information available about the elements (prudent assumptions for the calculation of load constraints, oversizing, etc.). It is also possible to reserve the timber elements for less demanding uses. It's a stylish way to extend their lifespan.

Depending on the application, it is necessary in all cases to refer to the European and national standards relating to the product (e.g. N 14081-1, etc.), conception standards (e.g. EN 1995: Eurocode 5 for the design and calculation of timber structures), to the rules of practice in force and to the installation standards. According to the regulations in force, it is also necessary to take into account the seismic, thermal and acoustic requirements, protection against termites, fire resistance, etc.

Despite their extensive knowledge of the materials and the valuable advice they can give, structural timber resellers generally do not certify all of the characteristics of the items they supply. On the other hand, some provide guarantees on aspects such as the uniformity of the batches, the dimensions of the elements, the maximum humidity level, the condition of the timber (without metal parts, mould, cracks, etc.) or even on its origin (some resellers thus affix the *FSC recycled label* which certifies that the wood comes from the dismantling of a building and not from the cutting of trees).

Depending on the intended use, the designer/specifier may need to specify his expectations regarding the following characteristics:

→ *Types and dimensions*. Leaving some latitude on dimensions, species, wood colour and all non-essential characteristics makes it easier to find a batch on the reclamation market. Since the dimensions of reclaimed "technical" timber do not necessarily correspond to the standard dimensions of new timber, this should be taken into account at the design stage. In addition, cautious assumptions when calculating the load conditions of structures (pessimistic data on timber quality) make it possible to compensate for the lack of information or certification of the material. It may also be relevant to carry out compensation measures based on the current conditions of use of the frame (reinforcement of the greatest bending moment, lighter load, shorter centre distance, oversizing of timber sections, doubling of columns, exclusion of damaged elements, etc.).

→ *State*. Depending on the requirements of the intended application, the designer/specifier can specify his expectations on the following aspects:

- no stubborn, rotten or bad knots;
- absence of traces of frost, rolling, knots, large cracks and felling signs, flaws;
- no deformation, timber not twisted;
- items free of pitting and large worm holes, traces of rot and mould;

- reasonable presence of nail and bolt holes - which give old timbers some of their character;
- moisture content;
- identification of resistance classification;

→ *Quantity*: to increase the chances of meeting the offer available on the reclaimed market, the designer/specifier can choose to split the batch with different species and batches.



Design of a 110 m<sup>2</sup> residential extension from reclaimed materials,  
© AASF Atelier Architecture Sarah Fruit, [Bati Recup](#) (FR)





**Characteristics and fitness for use**

Reclamation of elements for structural use generally requires knowing with sufficient precision the following specs ((related to the type of wood): moisture content, dimensional stability, natural durability of the timber, use class, mechanical resistance, reaction to fire and emission of dangerous substances. These characteristics, defined in the harmonized standard EN 14081-1, can be assessed by accredited professionals. Although detailed for new materials, they make it possible to consider the particular case of reclaimed rectangular section structural timber. Some of these characteristics are also relevant for non-structural uses.

Relevant characteristics	Comments
<b>Dimensional stability</b>	Closely linked to the type of wood, the drying and storage conditions, the degree of sorting of the elements and the uniformity of the batch, the actual dimensions of timber elements are influenced by swelling and shrinkage due to variations in moisture content. A visual or detailed examination can be sufficient to estimate them.
<b>Humidity level</b>	Depending on its function and location in the construction, the timber element must be installed at a balanced humidity level (for example: 15% < H < 22% for structural members and H < 18% for framework members). Reference should be made to the installation standards. The moisture content of the wood depends mainly on the drying and storage conditions of the reclaimed timber. It is measured using a moisture meter.
<b>Natural durability</b>	This characteristic evaluates the natural resistance of the timber (sapwood vs heartwood) to fungal attacks. It is assessed according to the species and makes it possible to determine the use class of the elements. It is possible to increase the natural durability by means of preservation treatments adapted to the species and the intended use. In this case, we can talk of "conferred" durability. In the case of reclaimed timber, even if it is possible to visually detect the presence or absence of preservative treatments, it is generally more complicated to determine the exact nature of the substances present.
<b>Use class</b>	The use class of the timber determines the appropriate uses ( <i>see table below</i> ). The harmonized European standard EN 460 defines five classes of use of timber and the associated biological risks. It recommends the possible application of an appropriate protective treatment according to the use and the natural durability class of the timber used (see standards EN 350-2 and EN 335). For example, roofing timber which does not come into contact with the ground, which is not exposed to bad weather and which is temporarily moistened must belong to use class 2.
<b>Mechanical resistance</b>	The strength class is the result of the classification of timber based on its mechanical properties (resistance to bending, compression, traction, shear, modulus of elasticity). It is determined according to the wood species, its density and the moisture content. In general, woods with a high density have better mechanical strength. The mechanical classes of timber pieces can be established by a machine classification or a visual classification ( <i>see box "Timber classification"</i> ). Visual classification seems quite appropriate in the case of reclaimed materials since it is complementary to the reclamation process set up by the dealers. Approved certifiers can accompany you.

Use class	General use	Biological risks		Natural durability class of wood				
		Insects	Fungi	I	II	III	IV	V
1	Indoors, in the dry	Yes	No					
2	Indoors, or under shelter, not exposed to bad weather. Possibility of water condensation	Yes	Low					
3	Outside, above ground, exposed to bad weather	Yes	Yes					
4	Outside in contact with the ground and/or fresh water	Yes	Yes					
5	Immersed in salt water on a regular or permanent basis	Yes	Yes					

Treatment not required  
Recommended treatment  
Treatment needed



Relevant characteristics	Comments
<b>Reaction to fire</b>	<p>Specific requirements for the reaction to fire are determined by national regulations. These requirements depend, among other things, on the use of the premises (for example: private or community housing, emergency exits, terraces on flat roofs, etc.), on the height of the building (for the façade cladding) but also on the ability of users to evacuate the premises in the event of fire (senior citizens' residence, hospital, etc.). It is therefore important for the designer/specifier to meet regulatory requirements in terms of reaction to fire by determining the materials and their method of implementation, with regard to the intended use.</p> <p>According to a European resolution (Resolution 2003/43/EC), the reaction to fire class D-s2, d0 is assigned without additional testing to all solid timber with a minimum average density of 350 kg/m<sup>3</sup> (measured according to a reference humidity, H=12%) and with a minimum overall thickness of 22 mm.</p> <p>The influence of a preservative treatment against biological attack or any other finishing treatment must also be taken into account. If necessary, the reaction-to-fire performance of the elements shall be tested and declared according to EN 13501-1.</p>
<b>Fire resistance</b>	<p>When calculating the fire resistance of timber structures (EN 1995 standard: Eurocode 5), the burning rate is evaluated using the geometric characteristics (dimensions of the elements, section, combination) and the properties of the material (species of wood, resistance, rigidity, characteristic density).</p>
<b>Toxicity</b>	<p>The timber elements may have been treated with toxic products or have been in contact with dangerous substances during their use. Most of the time, even though it is possible to visually detect the presence of preservative and finishing treatments, it is generally more complicated to determine the exact nature of the substances present. Laboratory tests may be required to assess the dangerousness of the contaminants present. The toxicity of some of these contaminants may have dropped drastically after several years in service. In the absence of information on this subject, it is best to stick to the "precautionary principle" or likely to interact with people, for interior applications.</p>

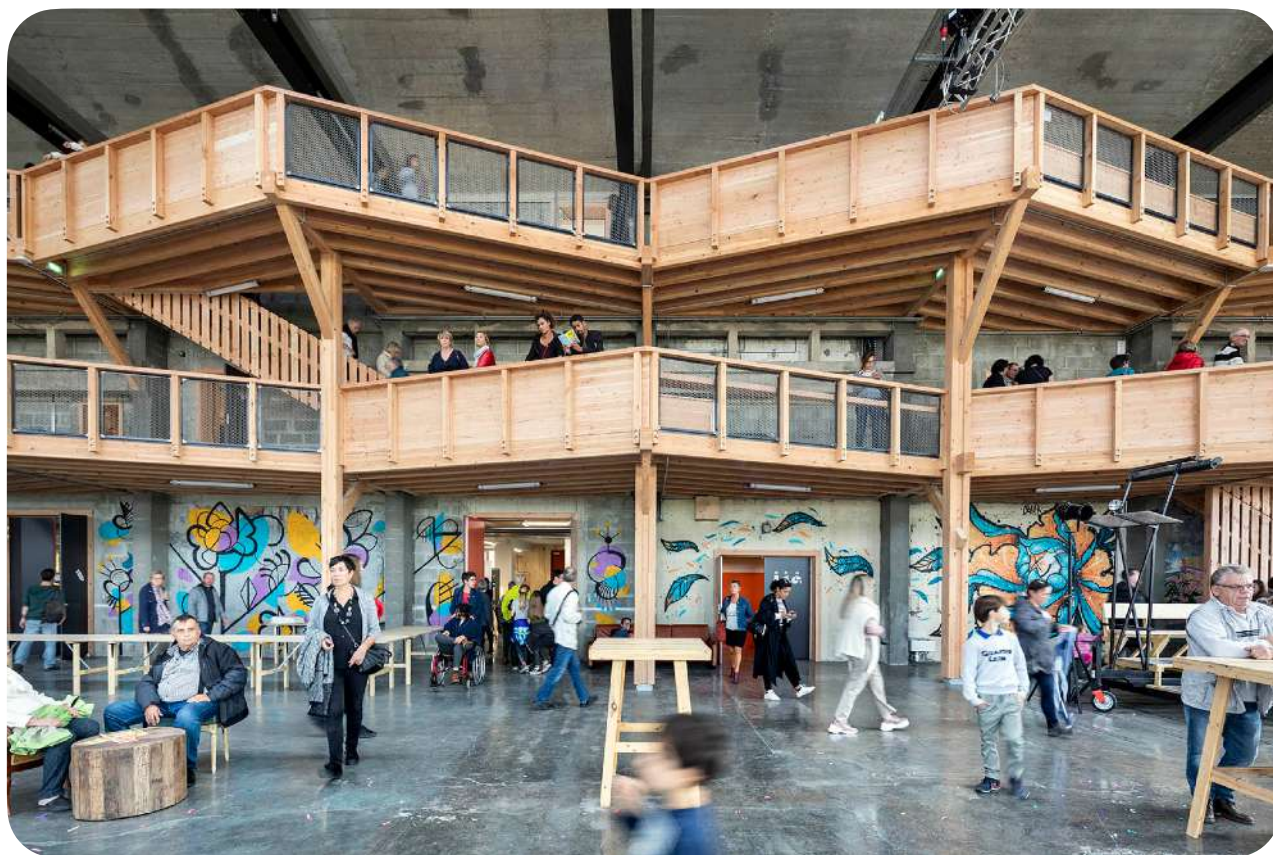

Reuse of structural timber in guardrail posts.  
© Cyrus Cornut, Grande Halle de Colombelles, WIP. Architectes : [Encore Heureux](#) (FR)



**Availability**

Beams are often available in sections from 150mm × 150mm up to 450 × 450mm, and in a wide variety of lengths (common dimensions up to 8m). Longer beams are rarer. Most of the reclaimed timber beams are made of oak, but they are also found in pine, elm, teak, etc. Professional resellers generally have large stocks and are able to respond quickly to most medium and small orders. Larger orders usually require a lead time in order to build up sufficient stock.

Timber joists are available in most standard sizes (60 × 150mm up to 80 × 24mm) in pine, oak, jarrah, etc. Resellers usually have large inventories which they can replenish quickly.

Structural timber is generally available in 50 × 100 mm sections, with a length of between 2.4 and 3 m. These are softwoods, most often pine. For large volumes (tens of kms), the amounts are likely to come from different supplies and have differences in colour, section, etc.

*Did you know?*

According to several Belgian dealers, the demand for old beams decreased between 1990 and 2000. Many suppliers who had a large stock then equipped themselves to transform these beams into flooring, cladding, doors, stair treads or furniture. The beams are generally cut as follows: the faces are cut and kept intact to make a weathered floor. The core of the beam is itself cut into smaller sized elements which in some cases are artificially aged to complement the rustic flooring ranges.

**Indicative prices (excl. tax)**

Random sampling of the reclamation market in Western Europe (Belgium, France, Great Britain and the Netherlands) made it possible to extract some indicative prices. These vary depending on model, condition and quantities needed. Some observed prices :

- Pine joists 6 × 16 cm: ~ 3.5 €/m
- Pine joists 8 × 24 cm: ~ 8.5 €/m
- Softwood joists (6 × 16 to 8 × 20 cm): 4 to 10 €/m depending on section

Generally, outlets prefer to supply lengths of 2.4-2.8m rather than 4m uprights because shorter lengths are easier to find. For lengths greater than 4 meters, a supplement may be added.

- Timber beams from old spruce trusses 90 × 400 mm: ~ 560 €/m³
- Old pine beams: variable price depending on the finish (planed or not) and the length: ~ 350 €/m³. The unit price is higher for long beams.
- Old oak beams: variable price depending on the finish (planed or not) and the length. For a 25 × 25 cm section: between 700 € and 2350 €/m³. The unit price is higher for long beams.
- Brushing/Cleaning: ~ € 20 per linear meter



Article on the importance of reclaiming timber elements despite the use of treatments that are currently prohibited: <https://www.salvoweb.com/salvoweb/29459-salvo-strongly-supports-the-salvage-and-reuse-of-reclaimed-timbers>

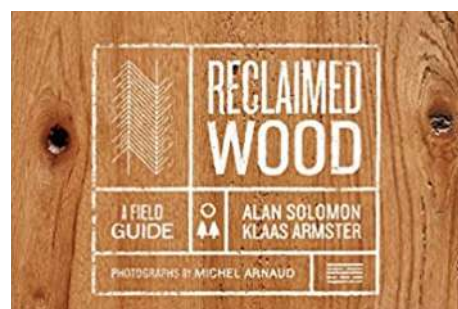

A book on reclaimed timber in the United States (history, recovery, examples of reuse and practical advice). Reclaimed wood: a field guide (2019), Alan Solomon & Klaas Armster, 240 p., Abrams edition, ISBN-13: 978-1419738180

**Find specialised businesses**



[salvoweb.com](http://salvoweb.com)

[opalis.eu](http://opalis.eu)



Feedback for the realization of a reclaimed wooden structure, YR Architecture Design: <http://www.yr-architecture.com/reclaimed-timber-preparing-reclaimed-wood-for-reuse/>

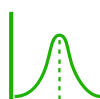

Assessing the impact of reclaimed timber construction products on global warming is complex and difficult to generalize. The general principle is that construction timber can confine biogenic carbon. Reclamation is therefore a way of preserving these carbon stocks and preventing it from being released into the atmosphere (which would be the case if the wood was incinerated, for example). The overall environmental assessment of a reclaimed timber element must, however, also take into account aspects such as the origin of the product and the distance travelled, the use of preservation treatment, etc. For more information, it is advisable to consult the specific paragraph devoted to this question in introductory sheet.





**Hazardous substances and precautions**

The solid timber structural elements may have been in contact during their use with dangerous substances or have been treated with toxic products, in particular to improve their resistance to biological agents, fire or humidity. Most of the time, even if it is possible to visually detect the presence or absence of preservative and finishing treatments, it is generally more complicated to determine the exact nature of the substances present. For certain molecules, simple revealing methods by colouring can sometimes be used (lead test, chromium azurol test, etc.).

In the example below, staining is applied to determine if the wood has undergone treatment. A red colouration indicates the absence of treatment while a bluish colouration demonstrates the presence of treatment.

Lead, copper, chromium, arsenic, PCP and certain biocidal molecules are among the dangerous substances likely to be found. Their concentration in timber, their effectiveness and their residual harmful power are difficult to estimate without implementing specific laboratory tests. In the absence of information on this subject, it is best to stick to the "precautionary principle" or likely to come into direct contact with people for interior applications. In addition, sawing, planing, sanding, etc. must be carried out by taking the appropriate safety measures (personal protective equipment, dust extraction systems, waste disposal, etc.).

Some types of timber treatment still offered today still involve toxic substances. Their use is highly regulated and reserved for certain applications. In any case, such processing could limit, or even completely compromise, the future reclamation of the elements thus treated.

For more information on the subject, you can consult the following document written by INRS (in French) which covers the main timber treatment products (constituents, dangers, uses, preventive measures): <https://www.inrs.fr/media.html?refINRS=ED%20981>



Red colour revealing an absence of treatment. © expert-bois.fr



Bluish colour revealing the presence of a treatment (limited to sapwood). © expert-bois.fr



Reuse of 2000 linear meters of solid timber structural elements. Redfox Commons (2019) (USA) © LEVER Architecture



Reclaimed wood frame partitions: 350 m³ of re-claimed timber to create the plasterboard partition structure, *BedZED*. © Bill Dunster Architects (ZEDfactory, 2002) (UK)



**Read more!**

Some general principles relating to the re-use of wood are detailed in the document :

"Methodology for diagnosis and performance evaluation for the re-use of industrialised frames" - Fondation Bâtiment Énergie (FBE). December 2020 (in French).

<http://www.batiment-energie.org/doc/70/FBE-ECB-enjeu-A-charpente-V1.pdf>

**Disclaimer**

This sheet is intended for designers, specifiers and other members of construction project teams wishing to reuse this building material or product. It is part of a collection of sheets aimed at bringing together the available information to date that is likely to facilitate the reuse of building materials and products.

This sheet has been produced by Rotor vzw/asbl within the framework of the Interreg FCRBE project - Facilitating the Circulation of Reclaimed Building Elements, supported by the entire project partnership. Sources of information include the experience of reclamation dealers and involved project partners, lessons learned from exemplary projects, available technical documentation, etc.

The sheets have been produced between 2019 and 2021. As the reclamation sector is evolving, some information, notably regarding pricing and availability, may change over the time. When the text refers to European standards, it is up to the project team to refer, if necessary, to their national implementations and local specificities.

It is important to note that the information presented here is not exhaustive or intended to replace the expertise of professionals. Specific questions are always project related and should be treated as such.

The complete collection of sheets (including the introductory sheet) is freely available from different reference websites (a.o. [opalis.eu](http://opalis.eu), [nweurope.eu/fcrbe](http://nweurope.eu/fcrbe), [futureuse.co.uk](http://futureuse.co.uk)).

Non-exhaustive directories of dealers in reclaimed building materials are available on [www.opalis.eu](http://www.opalis.eu) and [www.salvoweb.com](http://www.salvoweb.com).

---

Interreg FCRBE partnership: Bellastock (FR), the Belgian Building Research Institute / BBRI (BE), Brussels Environment (BE), the Scientific and Technical Center of Building / CSTB (FR), Confederation of Construction (BE), Rotor (BE), Salvo (UK) and University of Brighton (UK).

The information contained in this document does not necessarily reflect the position of all the FCRBE project partners nor that of the funding authorities.

Unless explicitly stated otherwise, the content of these sheets is credited in the Creative Commons Attribution NonCommercial – Share Alike format (CCBY-NC-SA).



Unless explicitly stated, the images used in this document belong to © Rotor vzw/asbl or © Opalis. Any other image has been the subject of a systematic request for authorisation from their authors or rightful owners. When this request has not been answered, we assumed that there were no objections to the use of the image. If you feel that this interpretation is unreasonable, please let us know.



**Material description**

**Glued laminated timber (Glulam) elements are produced by superimposing and laminating layers of planed wood timber. This technique, known for hundreds of years, has experienced strong growth during the 20th century. Glulam has become a structural element appreciated for its mechanical performance, its lightness, its ability to cross long spans (limited in practice by transport constraints) and the diversity of geometric shapes that it allows.**

The timber used for manufacturing is obtained by jointing wooden parts free from structural defects (knots, etc.). They are arranged so that their grain is parallel to the main direction of the element produced. The timber layers are assembled by gluing and pressing into the desired shape (straight or curved). The elements thus produced are then planed and machined in order to facilitate the placement and assembly of the connecting elements. Many finishing treatments are available, depending on the specific requirements of the intended use (appearance, fire resistance, protection against biological agents, etc.).

The manufacturers of new glulam give a reference lifespan estimated at 100 years, but it is not uncommon for buildings constructed with a glulam structure to be demolished much sooner. In theory, structural elements in glulam carefully dismantled during these demolitions could therefore be reclaimed, also for structural purposes. In practice, this approach remains rare, although a few pioneering projects illustrate the possibility of doing so and perhaps herald the devel-

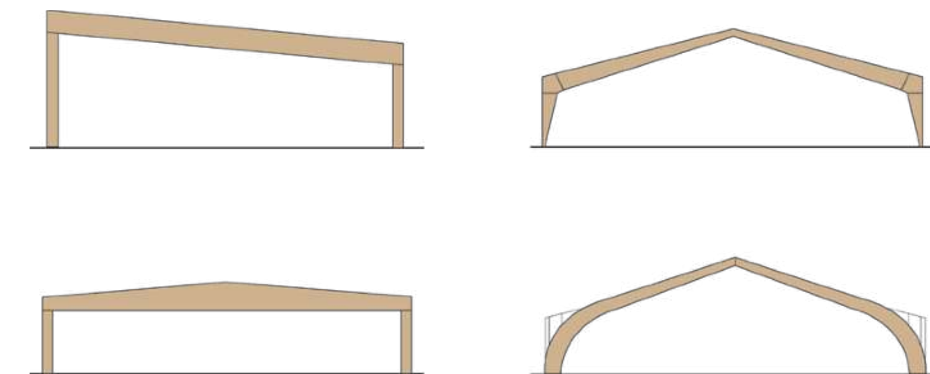

Examples of shape variability of glued laminated timber structural elements

opment of a promising sector for the future. Currently, the elements in glulam are most often reclaimed for non-structural purposes, for the realisation of furniture or in interior architecture for example.

Structural glued laminated timber should not be confused with CLT timber (*Cross Laminated Timber*, the layers of which have the particularity of being crossed at 90° in order to increase the rigidity and stability of the panel in all directions. ) or LVL (*Laminated Veneer Lumber* which is more like a very thick plywood). They also differ from glued laminated timber intended for furniture or carpentry.

Glulam beams generally differ according to the following criteria:

→ **Wood species.** Most of the time coniferous (e.g. spruce, fir, Scots pine, Douglas, larch), more rarely deciduous (e.g. poplar, beech or oak). The composition of a glued laminated wood element can be uniform (all the sheets are of the same wood species) or variegated (assembly of several species with different mechanical characteristics).

→ **Formats and dimensions.** The beams can be straight or curved, with constant or variable inertia, with straight or chamfered edges. The dimensions, number and arrangement of the sheets are variable and influence the mechanical performance and possible shapes.

→ **Appearance.** Depending on the natural colour of the wood, its degree of exposure to weather conditions, finishing or preservation treatments, etc. Reclaimed beams may bear marks left by previous uses: presence of fittings or holes in fittings, discolouration in the assemblies, etc.

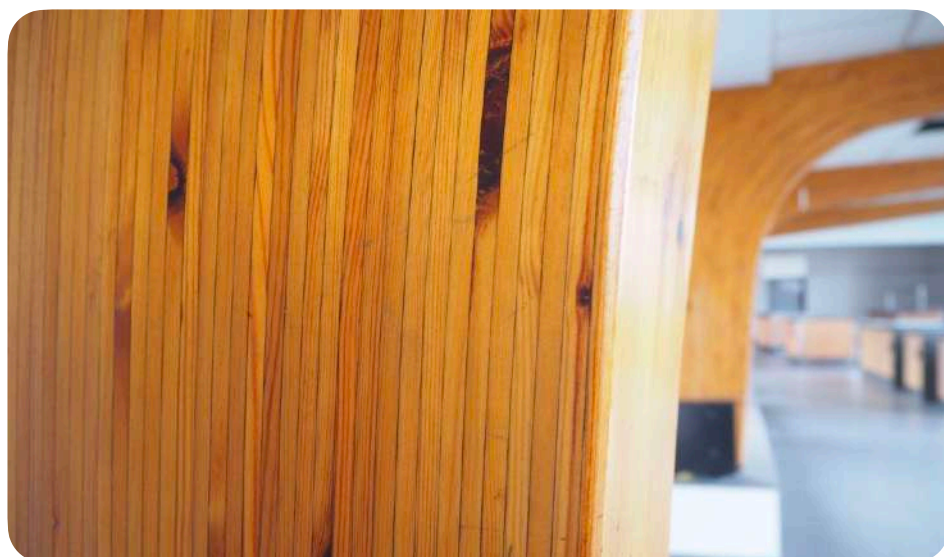



**Material reclamation**

**Currently, reclaimed glulam comes mainly from the dismantling of framing elements, floor beams or poles generally dating from the second half of the 20th century.**

The reclamation of structural elements in glulam requires good coordination as well as a certain level of expertise. It is preferable to be accompanied by professionals (structural engineers, control offices, demolishers, contractors, etc.) who will be able to guarantee the stability of the building via an adequate removal methodology, to ensure the feasibility and the profitability of a removal, and estimate the quality and quantity of elements in glulam in good condition in order to assess the interest of the batch.

Like solid wood, glulam elements can deteriorate when subjected to excessive moisture. The pathologies generally result from the presence of fungi which cause rotting of the wood or the presence of xylophagous insects. Shrinkage of the wood and the detachment of the sheets, due to significant variations in humidity, also lead to the formation of cracks into which excess water can penetrate. This is why an unprotected or poorly designed structure will potentially be more damaged. The horizontal parts of the beams and the assembly areas are the main areas at risk.

→ *Preliminary studies.* These aim to assess the general quality of the various elements. They can combine several approaches:

- *Visual inspection.* This makes it possible to check the characteristics of the wood (species, methods of joining the sheets, etc.) and to identify the presence of possible pathologies:

- cracks, not damaging or through
- detachments
- abnormal deformations
- discolourations
- presence of insects, fungi or areas of rot
- condition of fittings and mechanical assemblies
- condition of the protective layer (varnish, stain)

It will also be necessary to study what type (s) of stress the structure had to face during its use: exposure to polluting substances, operating overloads, accidents, etc. The analysis of the types of assembly also makes it possible to consider the most suitable removal method.

- *Basic tests:*

- 'Hardness' test using a resistograph. It allows the detection of superficial areas of rot.
- 'Screwdriver' test. Consists in causing a localised splinter using a blunt object. In healthy wood, the breakage occurs along the fibres while rotten wood tends to break in small pieces or in the middle of the fibres.
- 'Mallet' test. Consists in gently striking the wood to detect the presence of empty or rotten areas (emitting a hollow sound).
- Humidity measurement using a moisture meter.

- *Complementary studies.* Depending on the new, targeted uses, other studies may be carried out:

- Building history, based on the original documentation (executive plans, assembly method, calculation notes, original declaration of performance, technical documentation, etc.) and research on the conditions of use (maintenance of long-term occupants, identification of events such as fires, water infiltration, flooding, etc.).
- Geometric profile, based on a survey of the frame or framework by a surveyor to mark the dimensions of the elements and their connections.



Humidity measurement © SGI



Visual assessment of risk areas © SGI



Characterisation of cracks © SGI



Deterioration due to prolonged exposure to humidity © SGI



Characterisation of assemblies © SGI



Delaminating cracks © SGI



→ **Removal.**

- For a new structural use of the elements, care should be taken in preventing removal from causing torsional forces or deformation of the elements. To do this, the elements are first separated before being carefully extracted. The careful removal of structural elements requires good coordination and adequate technical means (cutting equipment, lifting equipment, etc.) to ensure the safety of workers and the integrity of the reclaimed elements. When lifting by crane, wide straps should be used and the edges of the glulam elements protected with steel angles or a similar system in order to avoid marking the elements.
- The removal method using a grapple clamp, frequently encountered on demolition sites, risks causing damage and deformation which limits or even compromises the reclamation of components for structural purposes. However, parts removed in this way can still be used for less demanding applications.

Once dismantled, the elements are preferably grouped, numbered and correctly identified in order to guarantee the uniformity and traceability of each part of the batch.

→ **Storage.** The elements are stored on the edge or flat, and in such a way as to be protected against external influences such as sun, rain, variations in humidity, contact with the ground, vegetation, etc. A waterproof tarpaulin can cover the glued laminated elements to protect them. In case of prolonged storage, the packaging should be opened to prevent or drain off condensation. The elements are placed on clean wooden transverse supports and thick enough to ensure good ventilation. A sufficient number of not impregnated wood spacer blocks of similar thickness are used when layering flat. Particular attention should be paid to the flatness of the elements in the event of long-term storage.

→ **Transport.** Depending on the length of the elements and the traffic rules in force, specific authorisations and resources may be necessary. Depending on the intended application and the initial length of the parts, it may be preferable to resize the elements on site for ease of transport. Ideally, the elements are protected to limit the risk of damage (mechanical damage, humidity, uv-rays, etc.). The use of wide and correctly positioned straps is recommended.

→ **Operations.** Depending on their condition and intended use, reclaimed glulam structural elements may go through several operations before being put back into use. Some suppliers automatically carry out some of these operations. However, sometimes the wood is salvaged or sold in its original condition. It is then up to the buyer to anticipate these stages. It may be interesting to involve producers of glulam elements in this process. These can contribute to the restoration of the elements.

- **Removal of metallic elements.** Nails, screws and other metal parts are removed using suitable tools. This laborious process is essential if woodworking is planned later, at the risk of damaging the machines. Using a metal detector makes it easier to locate metal objects.

- **Superficial cleaning.** By means of a soft or metal brush, by sanding or sandblasting according to requirements. Mechanical sanding makes it possible to remove the remains of paint or varnish for example.

- **Drying.** According to the hygrometric state of the wood. The elements are generally dried naturally in a shed, taking the necessary storage arrangements (spacing between the elements, no contact with the ground, wedges, etc.). Artificial drying can be carried out in certain cases in order to reduce the humidity level.

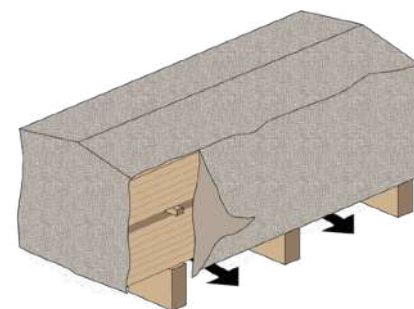

Covered storage scheme



Storage of reclaimed glulam beams



Preparing for removal

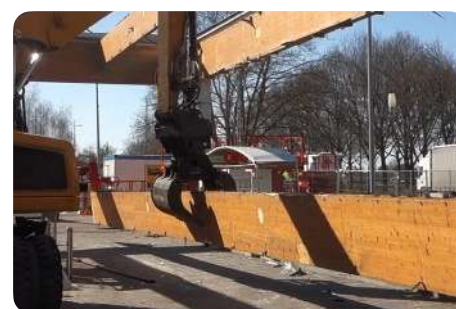

Removal of glulam beams



Removal of glulam beams



Transport of glulam beams





- **Preservation treatment.** In order to optimise the durability of wood outdoors or improve its service class, several types of preventive treatments are possible, for example by soaking, sprinkling, staining, in autoclave, etc. They are supervised through standards and recommendations for use. The large dimensions of the glulam elements may limit certain types of treatment. Professional advice is recommended, especially if the wood has already undergone this type of treatment before or if a topcoat is already present. Generally speaking, no surface treatment provides lasting protection against rot. In the absence of information on the original wood preservation treatments, it is not possible to consider reusing the elements in an unprotected outdoor space.

- **Sawing and cutting.** Glulam parts can be cut into smaller sections or re-cut to size. The beam thicknesses can also be cut using a portable saw or sawmill to obtain thinner elements, suitable for the realisation of furniture projects for example.

- **Planing.** The parts can be planed on one or two sides to obtain flat and constant sections and to correct the flatness defects resulting from a preliminary sawing.

- **Machining.** If necessary, new locations for the assemblies (connectors, fittings, etc.) can be machined. Numerically controlled machines offer a useful degree of precision in this case.

- **Repairs.** Filling cracks and small holes using wood filler or epoxy type resins (old assembly holes for example). Mechanical repairs are possible (addition of parts and reinforcements).

- **Finishes.** Depending on the intended uses, the wood can be left as is or receive a finishing coat (varnish, waxes, oils, stains, paint, etc.). Certain finishing treatments can improve performance linked to fire risks. Preferably, healthy finishing treatments that are not harmful to the environment should be used.



Removal of metal parts



Metal detector inspection



Splitter glued laminated timber (sawn lengthwise)



Planing



Planing



Processing a recycled Glulam for a table.  
© Crossroads Lumber, 2015.  
(<https://www.youtube.com/watch?v=YmB2cAdFDAQ>)





**Applications and installation**

**In principle, reclaimed glulam elements offer many possibilities for re-use. In practice, several scenarios can arise:**

- depending on the new application targeted:
  - Structural
  - Non-structural
- depending on the starting point of the design work:
  - From a still standing structure
  - From a batch of elements already dismantled and offered for sale by professional suppliers

The most demanding case is of course that of a structural application. This is governed by the standards of use, to which it is advisable to refer to (for example EN 1995: Eurocode 5 for the design and calculation of timber structures, EN 14080, etc.). According to the regulations in force, it is also necessary to take into account seismic, thermal and acoustic requirements, protection against termites, fire resistance, etc. To do this, it is recommended to involve specialist engineers as early as possible in the design process.

In the case of a structure still in place, they can recommend, supervise and interpret the preliminary analyses: visual inspection, preliminary tests, additional studies, etc. (see § Material reclamation). Based on this information, additional tests may be required (identification of species, condition of adhesives, flexural strength performance, etc.). In most cases, they are able to propose design approaches adapted to the level of information available:

→ conservative assumptions during the calculation of the structures' load conditions. For example, by adapting the edges or uncertainties as to the quality of the wood, by simulating a modelling based on the lowest mechanical class, etc.

→ compensation measures based on the current conditions of use of the framework. For example, by offering reinforcements where the bending is greatest, by shortening the centre distance between the uprights, by providing for lighter loads, by oversizing the elements (by doubling the posts, for example), etc.

The case of non-structural applications also requires a balance between the properties of the original material and the intended use.

Certain properties of the elements are detailed by professional suppliers who, in addition to reconditioning services, are generally able to provide information on the dimensions of the elements (thicknesses, length, width), their weight, species or even condition of the elements (presence of holes, cracks, metallic elements, etc.). It can also be useful to go on-site to see the quality of the batch.

Depending on the intended use, the specifier is required to specify his expectations regarding the following characteristics:

→ **Types and dimensions.** Leaving some latitude on dimensions, species, wood colour and all non-essential characteristics makes it easier to find a batch on the reclamation market.

→ **Condition.** Depending on the requirements of the intended application, the specifier can specify his expectations on the following aspects:

- Checking the good resistance of the adhesives (through specific tests or by visual inspection). If these are no longer viable, the elements may delaminate.
- The degree of imperfection tolerated, with regard to the intended use, by specifying the acceptance or rejection of these defects (for example, non-penetrating cracks < 30 cm etc.). This principle can be described in visual form to facilitate the examination of the glulam elements.
- Acceptable presence of holes and drill holes. If the project cannot accept them, a simple filling of cracks and small holes can be done using wood filler or epoxy-type resins. For structural use, other renovation methods exist by treating the deficient material by injection, mending or reconstitution, by replacing a damaged part with an artificial joint or by adding reinforcements.

→ **Quantity.** For non-structural use, and to increase the chances of meeting the offer available on the reclaimed market, the specifier can choose to split the batch with different species, colours and batches.

Most of the reclaimed building materials are sold as is on the reclamation market. The conditions of sale may however contain special guarantees specific to the material. Some suppliers are able to indicate the origin of the material and/or provide documentation on the product purchased (for more information, see the introductory sheet).

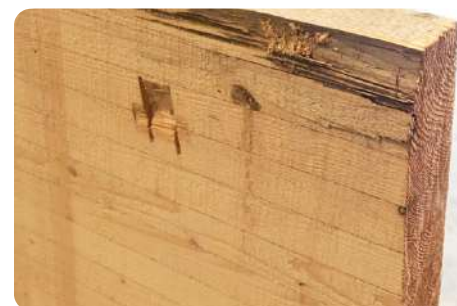

Presence of holes, cracks and damage on the reclaimed elements

**Portail du BOIS LAMELLÉ**

The laminated timber portal (<http://www.glulam.org>) published by the Union des Industriels Constructeurs Bois (UICB) brings together a great deal of information on glued laminated timber for construction and its uses (In French).



**Characteristics and fitness for use**

Reclamation of glulam elements for structural purposes generally requires knowing with sufficient precision the following specs, related to the type of wood: dimensional characteristics, moisture content, mechanical resistance, natural or imparted durability of the wood, use class, bond strength, reaction to fire and emission of dangerous substances. These requirements, defined in the harmonized standard EN 14080, can be assessed by accredited professionals. Although detailed for new materials, they make it possible to consider the particular case of elements in reclaimed glulam. Some of these characteristics are also relevant for non-structural uses.

Characteristics	Comments
<b>Dimensional stability</b>	Closely linked to the type of wood, the drying and storage conditions, the degree of sorting of the elements and the uniformity of the batch. The actual dimensions of glulam elements are influenced by swelling and shrinkage due to variations in moisture content. A visual or detailed examination can be sufficient to estimate the dimensional characteristics of the elements.
<b>Humidity level</b>	Controlling the humidity of the glulam is a guarantee of dimensional and mechanical stability. Depending on their function and their location in the construction, the elements must be installed at a balanced humidity level (for example: 15% max. for structural members) and with regard to the assigned class of service. Reference should be made to the installation standards. The moisture content of the wood depends mainly on the drying and storage conditions of the reclaimed wood. It is measured using a moisture meter.
<b>Useful life</b>	<p>The natural durability of glued laminated timber elements is measured against their resistance to fungal attack. It is identical to that of the wood species from which they are made and makes it possible to verify their compatibility with the assigned service class. It is possible to increase the natural durability by means of preservation or finishing treatments adapted to the species and the intended use. In this case, we can talk of 'conferred' durability. The use of preservatives is governed by standards and recommendations for use. It should be ensured that the treatment facilities are adapted to the size - sometimes considerable - of the glulam elements concerned.</p> <p>In general, the best way to protect wood is to ensure, during design, that decomposition cannot occur: by choosing a suitable species, by protecting the elements, by ensuring that they can dry quickly, or even by considering a specific treatment.</p>
<b>Use class</b>	<p>The use class of the wood determines the appropriate uses (see table). The harmonised European standard EN 460 thus defines five classes of use of wood and the associated biological risks, and recommends the possible application of an adequate protective treatment according to the use and the class of natural durability of the wood used (see standards EN 350-2 and EN 335). For example, roofing timber which does not come into contact with the ground, which is not exposed to bad weather and which is temporarily moistened must belong to use class 2. This classification is relevant for structural and non-structural uses.</p> <p>The application of preservation treatments on the surface of glulams does not allow going beyond use class 2. Usage classes 3 and 4 can only be obtained by treating the separate sheets, that is to say before gluing. Use class 5 does not apply to glulams.</p> <p>As part of the dimensioning of timber structures, the elements are assigned to a service class (EN 1995) directly influenced by the use class of the timber.</p>

Use class	General use	Biological risks		Natural durability class of wood				
		Insects	Fungi	I	II	III	IV	V
1	Indoors, in the dry	Yes	No					
2	Indoors, or under shelter, not exposed to bad weather. Possibility of water condensation	Yes	Low					
3	Outside, above ground, exposed to bad weather	Yes	Yes					
4	Outside in contact with the ground and/or fresh water	Yes	Yes					
5	Immersed in salt water on a regular or permanent basis	Yes	Yes					

Treatment not required  
Recommended treatment  
Treatment needed





Characteristics	Comments
<p><b>Bonding durability</b></p>	<p>In the context of the reclamation of glulam elements, the strength of the adhesive joints mainly concerns the butt joints within the sheets (most of the time with multiple finger joints) and the adhesive joints between the sheets. It can be checked through delamination tests or shear tests on samples. Determining this performance makes it possible to verify that variations in the humidity of the wood do not lead to delamination, that is to say an opening of the joints, for a determined service class.</p> <p>A rapid test (but not standardized) provides a first indication on the matter. It consists in applying a compressive force to a hollowed out part of a sample using a joint clamp to cause tensile stresses perpendicular to the grain of the wood (detachment stresses of the glue joint). If the rupture takes place within the fibres of the wood and not in the bonding, the rupture is said to be cohesive, which indicates satisfactory bonding.</p> <div data-bbox="438 633 1410 851" data-label="Diagram"> <ol style="list-style-type: none"> <li>1. Clamp (compression force)</li> <li>2. Glued laminated timber</li> <li>3. Recessed part</li> <li>4. Gluing plane between the lamellas</li> <li>5. Cohesive failure within the wood fibres</li> </ol> </div> <p>In general, a visual inspection of the elements provides a first glimpse of the condition of the glued joints. The results of this inspection can also be interpreted with regard to the service class of the element in its original use (for example, beams which would have been initially installed in service class 3, with strong variations in humidity, and which do not show traces of delamination, are likely to be suitable for reuse in service class 1, with slight variations in humidity. The reverse is absolutely inadvisable.</p> <p>Similarly, the type of glue used determines the service class in which the element can be installed. In the absence of precise information on the type of glue, it is therefore advisable to aim for a less demanding service class. The most commonly used adhesives for structural laminated timber parts are of three types: Melamine-Urea-Formalin (MUF), Polyurethane (PU) and Resorcinol-Phenol-Formalin (RPF). This third type, two-component synthetic, has been gradually abandoned in favour of the other two. Casein adhesives, solvent-free and environmentally friendly, used in the early 20th century were also abandoned as they no longer meet the current requirements.</p>
<p><b>Mechanical resistance</b></p>	<p>In industry, the mechanical resistance of new glulam elements is determined based on the mechanical resistance of the sheets used in their manufacture. To do so, each batch of sheets is characterized by a normative classification (visual or mechanical), which makes it possible to define a resistance class for glued laminated timber elements (e.g.: GL24, GL28, GL32, etc.). The various mechanical performances of the elements can therefore be calculated directly on the basis of this classification (flexural, tensile, compressive, shear strengths and modulus of elasticity) as well as on the basis of other material characteristics (species, density, resistance, rigidity, resistance of joints, dimensions and combination of sheets, etc.).</p> <p>In the case of reclaimed wooden elements, a visual and detailed classification of the timber by a competent and approved body is possible, which makes it possible, by means of conservative assumptions, to determine the mechanical performance of each glued laminated timber element.. Destructive tests on full-size beams are also possible. They require having enough elements within a batch to sacrifice one or the other). This information makes it possible to make the material suitable for its future use.</p>



Conversion into stair treads, Brussels (BE) © Zinneke



Conversion into guard railing, Brussels (BE) © Zinneke

Find specialised businesses



[salvoweb.com](http://salvoweb.com)

[opalis.eu](http://opalis.eu)



Characteristics	Comments
<b>Fire resistance</b>	When calculating the fire resistance of wooden structures (EN 1995 standard: Eurocode 5), the burning rate is evaluated using the geometric characteristics (dimensions of the elements, section, combination of sheets) and the properties of the material (species of wood, resistance, rigidity, characteristic density).
<b>Reaction to fire</b>	<p>Specific requirements for the reaction to fire are determined by national regulations. These requirements depend, among other things, on the use of the premises (for example: private or community housing, emergency exits, terraces on flat roofs, etc.), on the height of the building (for the façade cladding) but also on the ability of users to evacuate the premises in the event of fire (senior citizens' residence, hospital, etc.). It is therefore important for the specifier to meet regulatory requirements in terms of reaction to fire by determining the materials and their method of implementation, with regard to the intended use.</p> <p>According to a European resolution (Resolution 2005/610/EC), the reaction to fire class D-s2, d0 is assigned without additional testing to all glued laminated timber conforming to standard EN 14080, whose minimum average density is 380 kg/m<sup>3</sup> (measured according to a reference humidity of 12%) and the minimum overall thickness is 40 mm.</p> <p>The influence of a preservative treatment against biological attack or any other finishing treatment must also be taken into account. If necessary, the reaction to fire performance of glued laminated timber elements shall be tested and declared according to EN 13501-1.</p>
<b>Dangerous substances</b>	<p>Many types of glues have been used in the production of glued laminated timber components. In the absence of precise information, it is relatively difficult to determine their harmfulness and their impact on indoor air quality. Certain adhesives such as modified melamine resin and phenol-resorcinol resin may, for example, contain formaldehyde. However, it should be noted that the formaldehyde content in these glues is very low, and that the concentrations of volatile organic compounds (VOCs) in the ambient air will be well below the limit values imposed by the regulations for wood-based panels. If necessary, tests can be carried out to assess the release of formaldehyde. However, it is generally accepted that the emissivity of some formaldehyde-containing materials decreases over time.. The risk associated with the reclamation of glued laminated timber elements indoors can therefore be considered low.</p> <p>Glulam elements may also have been treated with toxic products or have been in contact with hazardous substances during their use. Most of the time, even if it is possible to visually detect the presence or absence of preservative and finishing treatments, it is generally more complicated to determine the exact nature of the substances present. Laboratory tests make it possible to identify and assess the dangerousness of any contaminants present. The toxicity of some of these contaminants may have dropped drastically after several years of service. In the absence of information on this subject, it is best to stick to the precautionary principle or likely to interact with people, for interior applications.</p> <p>Since glulam structures exhibit excellent behaviour in aggressive environments, they are frequently used in sheds intended for the storage of substances such as salts, acids, hydrocarbons, etc. Information relating to this use may therefore be useful in limiting the risks of toxicity associated with their new application.</p>

(1) Indoor Air Pollution: An Evaluation of Three Agents – Formaldehyde, Exposure to Environmental Hazard, University of Minnesota, PubH 5103, fall semester 2003.



Transformation into pieces of furniture. Offices in the Martyrs Square building, Brussels (BE). © Rotor



Transformations into pieces of furniture. Espace 16 Arts, Atelier d'architecture Alain Richard, Brussels (BE). © aa-ar

For more information on the subject, you can consult the following document written by INRS (in French) which covers the main timber treatment products (constituents, dangers, uses, preventive measures):  
<https://www.inrs.fr/media.html?refINRS=ED%20981>



In 2015, the Dutch company Bruil Beton & Mix allowed the integration of reclaimed glued laminated timber beams into the design of their new building. The spruce beams, taken from the old building, were individually inspected by the SHR inspection office, carefully dismantled and repaired by the company Heko Spanten (manufacturer of new elements). After drying, the beams were individually assessed to mark any damage and deterioration due to decay. Delamination tests were carried out on each part to check the state of the glue. The mechanical resistance class was determined visually (GL24h). All of these parameters were then used for structural calculations and sizing of the new building. The restoration of the beams consisted of a surface cleaning with water, a shortening in length, and a machining for the new assembly parts. A total of 13 beams measuring 16.100 × 890 × 133 mm were reclaimed.

(<https://naturalcapital.futureproof.community/uploads/71dbb80a7b0136dff3f57725f4b11762.pdf>) in HOUTWERELD, N° 11 (May 2015).



**Availability**

Glulam elements are not very common products in the reclamation market. However, some suppliers supplement their regular offer with batches of elements in glulam.

**Indicative prices (Excl. tax)**

Random sampling of the reclamation market in Western Europe (Belgium, France, Great Britain and the Netherlands) made it possible to extract some indicative prices. These vary depending on the models, condition and quantities needed. Some observed prices:

→ Glulam beam: 200 - 450 €/m<sup>3</sup>

Similarly, the Dutch company De Groot Vroomshop, which also manufactures new beams, contributed to the reclamation of 80 tonnes of arched beams, around 40 years old, from the demolition of an old ice rink (NL).

© De Groot Vroomshop  
<https://degrootvroomshop.nl/gelijmde-hout-constructies/hergebruik-houten-spanten/>

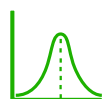

Assessing the impact of reclaimed timber construction products on global warming is complex and difficult to generalise.

The general principle is that construction timber can confine biogenic carbon. Reclamation is therefore a way of preserving these carbon stocks and preventing it from being released into the atmosphere (which would be the case if the wood was incinerated, for example). The overall environmental assessment of a reclaimed wooden element must, however, also take into account aspects such as the origin of the product and the distance travelled, the use of preservation treatment, etc. For more information, it is advisable to consult the specific paragraph devoted to this question in the introductory sheet.



Before reuse



Dismantling



Installation



After reuse

On-site reclamation. Standaertsite, Ledeborg Gent (BE), 2018. © AE / Carton123 / murmuur.  
<https://opalis.eu/fr/projets/poutres-en-lamelle-colle-reutilisees-sur-le-site-standaert>

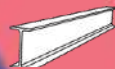

**Disclaimer**

This sheet is intended for designers, specifiers and other members of construction project teams wishing to reuse this building material or product. It is part of a collection of sheets aimed at bringing together the available information to date that is likely to facilitate the reuse of building materials and products.

This sheet has been produced by Rotor vzw/asbl within the framework of the Interreg FCRBE project - Facilitating the Circulation of Reclaimed Building Elements, supported by the entire project partnership. Sources of information include the experience of reclamation dealers and involved project partners, lessons learned from exemplary projects, available technical documentation, etc.

The sheets have been produced between 2019 and 2021. As the reclamation sector is evolving, some information, notably regarding pricing and availability, may change over the time. When the text refers to European standards, it is up to the project team to refer, if necessary, to their national implementations and local specificities.

It is important to note that the information presented here is not exhaustive or intended to replace the expertise of professionals. Specific questions are always project related and should be treated as such.

The complete collection of sheets (including the introductory sheet) is freely available from different reference websites (a.o. [opalis.eu](http://opalis.eu), [nweurope.eu/fcrbe](http://nweurope.eu/fcrbe), [futureuse.co.uk](http://futureuse.co.uk)).

Non-exhaustive directories of dealers in reclaimed building materials are available on [www.opalis.eu](http://www.opalis.eu) and [www.salvoweb.com](http://www.salvoweb.com).

---

Interreg FCRBE partnership: Bellastock (FR), the Belgian Building Research Institute / BBRI (BE), Brussels Environment (BE), the Scientific and Technical Center of Building / CSTB (FR), Confederation of Construction (BE), Rotor (BE), Salvo (UK) and University of Brighton (UK).

The information contained in this document does not necessarily reflect the position of all the FCRBE project partners nor that of the funding authorities.

Unless explicitly stated otherwise, the content of these sheets is credited in the Creative Commons Attribution NonCommercial – Share Alike format (CCBY-NC-SA).



Unless explicitly stated, the images used in this document belong to © Rotor vzw/asbl or © Opalis. Any other image has been the subject of a systematic request for authorisation from their authors or rightful owners. When this request has not been answered, we assumed that there were no objections to the use of the image. If you feel that this interpretation is unreasonable, please let us know.

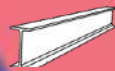

### Material description

**The Crystal Palace, a gigantic 92,000 m<sup>2</sup> glass and iron greenhouse built for the Great Exhibition in London in 1851, is one of the first demonstrations of the possibilities offered by the use of iron for the construction of large buildings. Incidentally, this building is also a prime example of the possibilities of reuse permitted by this method of construction. Originally located in Hyde Park, a contractual clause required its demolition once the exhibition was over. However, public opinion was against this sad fate. After many proposals, it was finally a certain Francis Fuller who bought the Crystal Palace. He had it dismantled carefully and completely reassembled in Sydenham (where it remained until it was destroyed by fire in 1936). The use of resistant parts, of relatively modest dimensions (the widest were cast iron beams 8 m long and weighing less than a ton) and the simplicity of the assemblies were key factors for the success of a such an operation.**

Although steel has now replaced cast iron, the same principles of modularity, workability, strength and reversibility make steel structural elements good candidates for reclamation. This sheet deals more specifically with the reclamation of steel beams, as independent elements, generally used in the structural construction of buildings. It therefore does not directly address the reclamation of the following elements:

- cast iron, aluminium, stainless steel beams or in other metal alloys;
- other metal construction elements (i.e. tubes and hollow profiles, welded steel tubes, angles, castellated beams, sheet piles, etc.);
- partial or complete structures based on still assembled steel beams;
- beam fasteners (plates, ball joints, etc.).

Nevertheless, the general principles described in this document are likely to be a guide for the reclamation of some of these elements.

In general, steel beams are used as simple load-bearing vertical (e.g. column) or horizontal elements (e.g. beams, lintels, joists, etc.), or as elements assembled in a metal structure (e.g. frame, structure, etc.). Their inclusion in a construction is generally validated by a stability design office and, in the case of frames and structures, a specialized builder is responsible for the preparation and delivery of the elements. Girders can be distinguished according to several criteria:

→ **Composition.** Today, beams are generally produced in unalloyed structural steel, mainly composed of iron, with a carbon content of less than 2% and which contains a limited content of certain other elements (e.g. manganese, phosphorus, sulphur, silicon, etc.). The composition of the steel largely determines the physical and chemical properties of the beams. As such, steel beams should not be confused with their cast iron counterparts (old and more fragile due to a higher carbon content), aluminium (lighter, extracted from bauxite, possessing different material properties), stainless steel (which is another steel family characterized by a high chromium content) or other metal alloys.

→ **Production method.** Steel beams are finished products (or semi-finished if they still have to be machined) from the steel industry. They are traditionally classified as long and hot rolled products.

→ **Age of the elements.** The use of steel in construction has become widespread since the late 19th century. In general, it is considered that steel produced since 1970 complies with modern product specifications and calculation methods based on Ultimate Limit State (ULS) and Serviceable Limit State (SLS) testing.

→ **Steel grades and qualities.** A numerical classification system for the type of steel the beams are made from allows them to be differentiated based on their mechanical characteristics. In short, structural steels are designated by:

- the letter S ("structural")
- the minimum elastic limit in N/mm<sup>2</sup> (for a thickness of 16 mm)
- a grade referring to their "quality" (according to the specified value of fracture energy at impact bending: JR, JO, J2, K2).

The most common grades of steel used in the manufacture of beams are S235JR / S275JR / S355J2 (where S235JR stands for "structural steel with a yield strength of 235 N/mm<sup>2</sup> and a guaranteed minimum breaking energy of 27 Joules at 20° C"). There are also steels with high yield strength and steels with improved resistance to atmospheric conditions. There are equivalence tables which make it possible to characterize steels graded according to old standards.

The original technical documentation makes it possible to know the steel grade of the reclaimed beams. If this is not available, it is possible to request a physical and chemical analysis by an approved laboratory.

→ **Shapes and profiles.** Structural grade steel beams come in many standardized shapes and sizes. Common models are the profiles IPN, IPE, HEA, HEB, HEM, UPE and UPN (where the first letter refers to the section shape, see Figures 1 to 3). Their dimensions are standard and their respective masses and properties are fixed in standard EN 10365. The mechanical properties differ according to the profiles.

### CE Marking

*CE marking has been compulsory for new structural steels since 2014 and is addressed in standard EN 1090-1. The EN 1090-2 standard stipulates that elements not covered by the mentioned standards (such as reclaimed steel) can be used if their relevant properties are specified and indicated. In the case of reclaimed beams, it is relatively simple to refer to the specifications of European standards for new products in order to demonstrate the fitness for use of the elements. This process can make use of a visual estimate of the condition of the elements, charts showing the performance of new homologous elements, laboratory grade tests and a global strategy of oversizing the structures.*

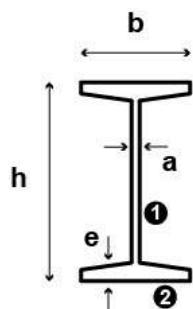
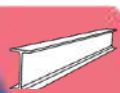

Figure 1. IPN profile  
(inclined flanges with variable thickness)

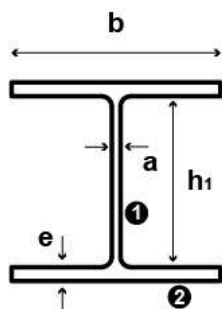

Figure 2. HEA profile  
(Parallel flanges)

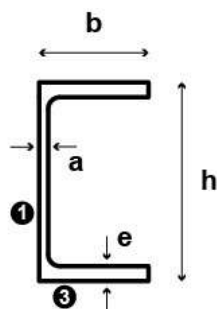

Figure 3. UPE profile

Figures 1 to 3: Common profiles of steel beams

1. "web".
2. "Flanges".
3. "Flanges".

- a. Thickness of web
- b. Width of flange
- e. Thickness of flange
- h. Depth of web (including flanges)
- h1. Depth of web (excluding flanges)

→ **Surface finish.** Depending on the intended use, the beams may have undergone different treatments:

- **Untreated:** recognisable by their dark colour and rusty rolling scales. Untreated beams are often used for invisible applications.
- **Coated with an anti-corrosion primer:** these beams can be recognised by their reddish-brown surface and are often installed in a non-visible interior application or provided with a subsequent finishing coat (paint).
- **Hot-dip galvanised:** coated with zinc and/or iron/zinc alloys through immersion. The surface alloy thus creates a thicker anti-corrosion layer, with a matt surface, suitable for more demanding exterior applications.
- **Metalled:** having undergone thermal spraying of a metal or an alloy.
- **Coated with fire protection:** in the form of intumescent paint, flocking, etc. (n.b. some flockings are likely to contain **asbestos**, see § "Hazardous substances and precautions" ).
- **Other organic paints, powder coating, etc.** These processes provide lighter protection and colouring of the elements. Typical of visible interior applications.

Depending on the new intended use, the original finish may need to be cleaned by sandblasting, shot blasting or chemical dipping. These operations are subject to specific normative provisions.

→ **Fixings.** Several fixing methods are to be found:

- Mechanical, by riveting or bolting, by means of accessory parts and junction elements (studs, bolts, rivets, plates, ball joints ...).
- Welds.
- Fixing in masonry.

Depending on the means used during removal, it is common to find certain accessories attached, as well as traces of the previous fixing method (e.g. remains of mortar, welded parts, reinforcements, junction elements, etc.).



Natural, untreated beams



Reclaimed IPE beams, with anti-corrosion protection treatment. © Opalis (Omgekeerd Bouwen)



Galvanised steel beams © lecoindupro



Flocked beams



Painted beams



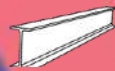

## Material reclamation

**Recent steel beams are a standardised product. With good coordination, their careful disassembly for reclamation is usually easy. The beams thus dismantled are suitable for reuse on site or via professional channels of material dealers (who can also ensure the supply of reclaimed beams).**

This sheet deals with the case where the beams are dismantled separately and reassembled independently, although it is also possible to recover complete structures or complete structural elements (trusses, etc.).

→ **Preliminary examination.** In practice, it makes it possible to identify and list reusable beams and to ensure the feasibility and profitability of removal with a view to reuse. In the case of isolated elements (such as lintels), an "expert eye" is often able to estimate the interest of a batch based on photos or by an on-site visit. When the objective is to recover a complete or partial metal structure, it is preferable to carry out an in-depth examination of the batch and of the elements taken separately (general and detailed plan, surveys, etc.). In all cases, the points of attention relate, among others, to:

- the general condition of the elements/ batch: quantities, dimensions of the elements, nature and condition of the surface coating, presence/absence of holes and reinforcements, visible damage, etc.;
- the installation method (i.e. bolts, rivets, welds, fixing), the condition of the assemblies and the dismantling of the elements;
- the commercial interest linked to careful removal, depending on the model and quantity of beams, and on logistical arrangements, particularly in terms of lead time, working time, implementation of safety measures, handling, transport, etc.

→ **Documentary research and checking the quality of the steel.** Before proceeding with the actual removal, it may be necessary to determine the general characteristics of the building and the beams which constitute it, in order to ensure their suitability for dismantling and reuse. This involves identifying the conditions of use of the material and finding information from the building archives, from the original architects, engineers and/or contractors, or from other local sources. This information may relate to:

### Restrictions

Different reference documents (see § "Did you know") agree on the fact that elements meeting the following conditions **should not be reclaimed**:

- Girders having been subjected to extreme point loads, strong impacts or fires.
- Girders subject to fatigue, that is to say a weakness acquired by a metal having undergone excessive stresses which locally modify its internal structure. This phenomenon manifests itself through the appearance of cracks (before breaking). This can be caused by repeated impact or vibration cycles. These conditions of use are quite rare in the building industry, but they can be found, for example, in lift shafts, overhead cranes, road bridges, railway tracks, etc.
- Girders coming from extreme applications (e.g. subjected to radioactivity, etc.).
- Girders showing a significant loss of their cross section due to corrosion (one of the documents sets the limit at 5% of the thickness of the element). This scenario is mainly encountered on buried beams or those subjected to a high humidity level.
- Girders showing visible (or suspected) signs of plastic deformation.
- Girders produced before 1970 because their composition probably does not correspond to contemporary steel standards. Their fitness for use can nevertheless be established, subject to carrying out specific analysis and tests.

- **the building:** date of construction, plans, geographical location, type of use and stresses (e.g. corrosive conditions, seaside), possible disasters (e.g. fires, floods, earthquakes, impacts), etc.
- **the beams:** technical sheet of the elements (e.g. type of profiles, grade and quality of the steel, type of coating), their function (e.g. column, beam, lintel, etc.), stresses (e.g. inside/outside, corrosive atmosphere, nature of the loads), possible repairs, etc.

→ **Removal.** As it relates to the structure and may involve working at height, the careful disassembly of steel beams requires good coordination to ensure worker safety and maintain the integrity of the beams.

→ To guarantee the traceability of the elements, it is strongly recommended to carry out their individual identification by means of a physical marking (preferably on the core, by means of labels or markers resistant to wear, erasure. and to light).

→ The elements assembled by bolting can be dismantled mechanically, or by cutting as close as possible to the connections in order to maximise the length of the recovered elements. A few points to note:

- Bolts can plastically deform under stress. These deformations should be closely observed during dismantling, to limit the risks of breakage and instability.

- Welds can suddenly fail. The removal of joints with critical welds requires the constant assistance of a lifting device to relieve the load on the joints.

- The beams must not fall to the ground.

→ **Cleaning and sorting.** On site or in the workshop, the beams recovered are generally sorted by grade and given a rough cleaning. They are freed from mortar residues and the accessory elements that may interfere with transport and handling are completely or partially removed (reinforcements, connecting elements, etc.). The beams showing some deformation or suspicious traces are eliminated from the batches intended for reclamation.

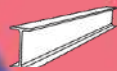

## Steel beam

→ **Operations.** While some beams can be reused as is after a rough cleaning, others may require additional operations such as:

- **Cutting:** Girders can easily be cut to a specified length. The processes used (e.g. cutting, shearing, cutting, water jet cutting, flame cutting, etc.) must meet the requirements in terms of dimensional tolerances, maximum hardness and symmetry of the edges.
- **Machining:** the beams can be machined in the workshop to meet the needs of the future project (tapping, welding of additional elements, bending, notching, drilling, etc.). It is not always necessary to remove old welded joints, stiffeners, corner bars, etc. Making new bolt holes and other holes is possible, provided they are made at a sufficient distance (usually 100mm) from existing bolt holes and other holes. All machining operations must meet the specifications applicable to new steel beams (e.g. EN 10034 for I and H beams).
- **Finishing:** the corrosion/fire protection (if present) may have been damaged during removal. Consequently, the performance of the original coating may be compromised and no longer correspond to the required level for the envisaged new use. Refer to the standards in force and carry out additional tests to determine the initial performance of the original coating if necessary (see § "Characteristics and fitness for use").

- Some original coatings may contain dangerous substances (e.g. lead, asbestos, see § "Hazardous substances and precautions").
- It is not advisable to rely on original fire protection coatings as they are often sensitive to moisture and strongly related to the original shape, location and application of the element prior to its disassembly.
- If the application of a new surface coating is envisaged, it is advisable to determine the nature of the original coating, to proceed with its appropriate removal (e.g. sandblasting, shot blasting, chemical dipping) and to respect the installation conditions and preparation of the new coating (the normative specifications to be respected are generally the same as for new steel beams).
- One-off repairs to the old coating may be necessary due to damage caused by removal and/or by operations linked to the reclamation of the element (e.g. cutting, welding, etc.). Compatibility of repair products should be ensured.

### Tip: batch formation!

If tests are required to grade the performance of the steel or the beams, it is advisable, during removal, to group the identical elements into clearly defined batches.

The grouping criteria can be the type of coating, the shape and size of the elements, or their original application (interior/exterior, corrosive environment, load level, etc.).

This technique makes it possible to facilitate the subsequent sampling of the batches as well as the interpretation of the test results.



Recovered beams with welded connections  
© [Gebruikte bouwmaterialen Weert](#)



Deterioration of the original coating  
© [Gebruikte bouwmaterialen Weert](#)



Distorted corners  
© [Gebruikte bouwmaterialen Weert](#)



Installation for cutting beams  
© [Opalis \(Wolter Bouwmaterialen\)](#)



Cut beams  
© [Opalis \(Wolter Bouwmaterialen\)](#)



Rework of beams  
© [Opalis \(Général Métal Réédition\)](#)





## Steel beam

→ **Handling and storage.** Due to their heavy weight (the density of steel is 7850 kg/m<sup>3</sup>), beams are generally handled with suitable lifting gear. For long elements, it is advisable to use several lifting points. It is best to properly protect the lifting points, especially if a maintenance of the coating is envisaged. Steel elements can be stored outdoors, without protection against moisture or frost. However, it is advisable:

- to avoid storing the elements directly on the ground, in order to limit corrosion,
- to avoid creating water accumulation areas on the beams,
- to provide sufficient support points to avoid deformation,
- to store the elements in distinct batches, correctly listed (see box “Tip: batch formation!”).

→ **Transport and delivery.** All necessary precautions must be taken during transport and delivery (fixing, loading and unloading material, etc.). Due to the size and weight of the elements, transportation can be quite expensive. Therefore, many professional suppliers of reclaimed beams prefer to avoid transportation and storage costs by selling the beams directly from the dismantling site.



Storage of reclaimed steel beams, coated with corrosion protection (in red) and uncoated (rust and white paint) © *Gebruikte bouwmaterialen Weert*



Storage of beams by profile and shape © *Opalis (Sarl Perrin)*



Storage of recovered beams on wooden supports © *Opalis (Premys Ferrari)*

### Inspiration

Several inspiring projects demonstrate that the reuse of metal structures on the scale of entire buildings is a practice that is not only possible but also interesting from an environmental and economic standpoint. The success of these projects is generally based on a combination of factors such as collaborations with specialist suppliers, the mobilization of design offices to analyse the properties of the beams and an innovative approach in demonstrating their fitness for use

→ <https://projectsites.vtt.fi/sites/progress/cases.html>



Bedzed Project (2002), Hackbridge (UK). Reuse of 95 tonnes of steel © *Bill Dunster Architects, ZedFactory*

[https://library.uniteddiversity.coop/Ecological\\_Building/BedZED-Toolkit-Part-1.pdf](https://library.uniteddiversity.coop/Ecological_Building/BedZED-Toolkit-Part-1.pdf)





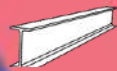

### Applications and installation

**Reclaimed steel beams are suitable for a wide variety of applications. They can be reused for structural and non-structural purposes, both indoors and outdoors.**

More demanding applications may require careful determination and/or checking of material properties (see § “*Characteristics and fitness for use*”). Reclaimed steel beams are generally not suitable for extreme applications, where technical performance is exploited to the maximum, and where the margin of error is extremely small (e.g. structural applications subject to high stress or fatigue, applications requiring high deformability, seismic applications, etc.).

For structural applications, it is advisable to involve stability engineers early enough in the design process to, on the one hand, determine the appropriate beam types based on the preliminary design and, on the other hand, develop the design correctly based on available profiles, including conservative assumptions needed for structural design, oversizing, etc.

The assembly of reclaimed steel beams is done in the same way as for new beams. When welding, the carbon equivalent value (CEV) of the profiles must clearly be taken into account. This value indicates the weldability of the beams. In particular, it is determined by the chemical composition of the steel. If necessary, the carbon equivalent can be determined through destructive and/or non-destructive tests (see § “*Characteristics and fitness for use*”).

Depending on the application, account must be taken of the relevant standards, good practice and applicable execution standards (e.g. EN 1090-2: “Execution of steel structures and aluminium structures - Part 2: Technical requirements for steel structures”).

Some suppliers of reclaimed materials are able to provide information on the origin of the beams, their dimensions and the type of profile, but more rarely on their technical characteristics. The lack of information or certification of the material must then be compensated by conservative assumptions on the technical characteristics of the steel (e.g. compensation measures, safety factor, oversizing, etc.) and/or through additional tests.

Depending on the intended use, the designer/specifier may need to specify his expectations regarding the following characteristics:

→ **Types and dimensions.** In order to increase the chances of finding suitable elements from professional suppliers, it is advisable to specify as wide a range as possible of beam types and profiles that can be used in the design. Often, it is sufficient to specify a minimum length rather than an exact length, as the profiles can easily be cut to the desired length afterwards.

→ **Condition.** Salvaged steel does not often look the same as new steel. There may be bolt holes or other holes in the elements, as well as welded fittings, stiffeners, corner bars, etc. These marks are usually not a problem per se and can be left as is. If necessary, a

limit can be placed on the size and/or location of the existing (bolt) holes. Girders with bolt holes and other holes, or traces of surface rust, are generally suitable for reuse, but may have limitations with respect to the addition of new holes and their section characteristics.

→ **Finishing.** As discussed in the “*Material Reclamation*” section, it is not advisable to rely on the original coatings and it is often preferable to apply a new coating, in accordance with the requirements of the new use.

→ **Quantity.** To increase the likelihood of meeting the available supply in the reclamation market, the designer/specifier may choose to split the batch into smaller batches, or appoint a third party company to collect the elements. It is advisable to leave the possibility of supplementing the batch of reclaimed beams with new elements at key points of the construction and/or to supplement the quantities found.

Most of the reclaimed building materials are sold as is. The sales conditions may however contain specific guarantees specific to the material (for more information, see the *introductory sheet*).

### Inspiration



NTS Building (2017), Thirsk (UK). Reuse of structural steel beams © Cleveland Steel and Tubes (CST)

<https://www.steelconstruct.com/wp-content/uploads/CS01-NTS-building-Thirsk.pdf>

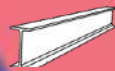

**Characteristics and fitness for use**

Steel is a very durable material with very limited deterioration of its technical characteristics during use and under normal conditions. To assess the fitness for use of reclaimed steel beams, and depending on the field of application envisaged, it is often necessary to know certain characteristics of the elements (see table below).

Depending on the intended uses, the project team - and in particular the stability design office - assesses whether tests are necessary to determine and verify the mechanical properties and chemical composition of the steel in the reclaimed steel beams. Grading of certain properties may require destructive testing on a sample or non-destructive testing on each separate element. The extrapolation of the results to include the whole batch must be validated by an appropriate sampling method and statistical approach.

The quantity of samples required and the nature of the tests to be carried out can have an impact on the economics of the project, which should therefore be anticipated. A few remarks about this:

- Yield strength, maximum tensile strength, toughness and chemical composition are standardised for steel beams manufactured after 1970. **Knowing precisely the grade and steel quality of the beams to be reused largely determines the quantity and nature of the tests that will be necessary to justify their fitness for use.** As such, it is therefore useful to consult the technical data sheets and the original execution documents. Most of the time, if this information is known, a simple visual inspection of the components can be sufficient to determine their fitness for reuse. If this information is not available, the use of grade tests should be considered in view of the requirements of the new application.
- Structural buildings are classified into **three normative consequences classes** (abbreviated to CC, "consequences classes") according to the consequences of the collapse of the structure and the loss of human life. These are coupled with **execution classes** (EXC), which regulate the level of execution, quality assurance and inspection and testing (see Eurocode EN 1090-2: 2018). Buildings in higher performance classes have more requirements to determine and/or verify the technical characteristics of structural elements.
- The principles of oversizing in the **design**, the use of additional safety factors and/or the adoption of minimum values for certain characteristics can also reduce the need for in-depth testing. Sometimes, however, it will be more economical to demonstrate certain characteristics through tests in order to get the most out of beam performance.
- The execution of the steel and beam grade tests is entrusted to approved laboratories which have the appropriate infrastructure and which can guarantee the correct sampling of batches, analysis and interpretation of the results obtained.
- Several practical manuals offer concrete methodological procedures to support the reclamation of steel beams. These documents indicate, among other things, which tests are necessary for which types of applications, on how many samples must be carried out and whether or not they must be carried out statistically (see § "References").

Characteristics	Comments
<b>Dimensional characteristics (length, width, thickness)</b>	These characteristics are closely linked to the degree of sorting of the recovered elements. A careful visual examination accompanied by simple measurements is often sufficient to evaluate them. The cross section dimensions of steel beams have generally been standardized since the 1970s (see EN 10365 for hot rolled U, I and H sections).
<b>Dimensional tolerances and geometry</b>	The cross-sectional tolerances and geometry of the beams are specified in various European standards (EN 10034 for I and H sections). A visual or detailed examination of the batch is often sufficient to estimate them.
<b>Toughness/impact resistance</b>	<p>Toughness (or resilience) is the ability of steel to absorb energy and to deform plastically under sudden impacts or forces without breaking or cracking. This characteristic depends on the steel grade and the ambient temperature. It is often specified in technical documentation (for example by the initials JR in "S 275 JR") for steels manufactured after 1970.</p> <p>This property should be taken into account for specific and demanding applications, generally in an outdoor environment and when the temperature is very low. For interior steels which are not subjected to fatigue, a conservative assumption is often sufficient (i.e. the JR quality, the lowest quality, as defined in standard EN 10025, can be estimated without testing). In some cases, however, it is useful to prove, by means of destructive testing (Charpy test), that the steel has better toughness than this minimum value.</p>

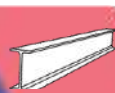

Characteristics	Comments
<p><b>Mechanical resistance</b></p> <ul style="list-style-type: none"> <li>• Yield strength</li> <li>• Tensile strength</li> <li>• Elongation at break</li> </ul>	<p>The <b>yield strength</b> indicates the maximum load beyond which the material is deformed permanently (one says then that it enters the “plastic” zone). <b>Tensile strength</b> refers to the maximum load that an element is able to take before failing and then breaking.</p> <p>These characteristics depend on the nominal thickness of the elements and are indicated by the steel grade. For example, a steel beam (16 mm thickness) with steel grade S275 indicates that its yield strength is 275N/mm<sup>2</sup>. This same indication makes it possible to establish that its maximum tensile strength is around 370 - 530 N/mm<sup>2</sup>.</p> <p>When this information is not available, it can be established by grade tests:</p> <ul style="list-style-type: none"> <li>• <b>Destructive tensile tests</b> on a representative sample (for a batch of reclaimed beams, the degree of reliability increases with the number of samples, see EN ISO 6892-1). Tensile testing can also determine <b>elongation at break</b>, which refers to the ability of the material to elongate before breaking (when subjected to a tensile load) and which is an important property to know in some specific applications.</li> <li>• <b>Non-destructive hardness tests</b>, using a portable hardness tester. Under certain conditions (test protocol), the measurement of the hardness of steel allows to estimate the yield strength as well as the tensile strength of elements by means of tabulated values (see EN ISO 18265).</li> </ul> <p>These characteristics are also used to model the behaviour of beams under bending, compressive, shear stresses etc.</p>
<p><b>Reaction to fire</b></p>	<p>Steel is considered a non-combustible material (Euroclass A1), which does not emit heat or smoke. However, it quickly loses its strength and rigidity in the face of the high temperatures reached during a fire. Ambient heat can deform steel members and cause structural instability.</p> <p>Class A1 only concerns steel and is not applicable to beam coatings. It is therefore necessary to know the reaction to fire of the finishing products used (e.g. paint, etc.)</p>
<p><b>Fire resistance</b></p>	<p>Specific fire requirements are determined by national regulations. These requirements depend, among other things, on the use of the premises (for example: private or community housing, emergency exits, terraces on flat roofs, etc.), by the building’s height, but also on the ability of users to evacuate the premises in the event of fire (senior citizens’ residence, hospital, etc.).</p> <p>At a European level, the classification of the fire resistance of different building elements is described in standard EN 13501- 2. It is expressed by a period of time R<sub>f</sub> (in minutes) during which a construction system satisfies the criteria of stability (R), flame tightness (E) and thermal insulation (I).</p> <p>To this end, the construction elements or systems are generally dimensioned and designed according to Eurocode standards to meet national requirements. In the case of structural steel elements, depending on the application, it will mainly be a question of delaying the temperature rise, in order to maintain the bearing capacity of the structure as long as possible:</p> <ul style="list-style-type: none"> <li>• either by oversizing the elements (thicker elements take longer to heat up);</li> <li>• or by applying a fire-retardant coating to the steel surface (e.g. plates, intumescent paints, mortar flocking, etc.)</li> <li>• or by encasing the structural steel elements in concrete.</li> </ul>
<p><b>Suitability for welding - “weldability”</b></p>	<p>In the absence of precise information, an analysis of the chemical composition of the steel and a metallurgical examination may be necessary to determine the weldability of the steel.</p> <p>The chemical composition can be determined non-destructively by optical emission spectroscopy (mobile or laboratory equipment) or destructively by taking a sample (cutting one end or taking shavings by drilling).</p> <p>The metallurgical examination (microscopy) is carried out by sampling and makes it possible, among other things, to grade the steel structure, the steel grain size and the purity.</p>
<p><b>Sustainability</b></p>	<p>This characteristic mainly concerns the state and nature of the protective anti-corrosion coating. When used outdoors, the steel must be properly protected in accordance with the standards in force. In an indoor or non-corrosive atmosphere, no special requirements are necessary.</p>



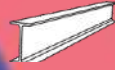

In some special cases, other characteristics should be assessed, for example:

- Contraction needs for certain types of connections/assemblies
- Limits on internal lack of continuity or cracks in areas to be welded
- Behaviour at high temperatures (creep test)
- Fatigue behaviour (torsion, rotary bending, repeated impact tests)
- Thickness requirements.



Portable hardness tester © PCE Instruments France

**Références**

*EUROPEAN RECOMMENDATIONS FOR REUSE OF STEEL PRODUCTS IN SINGLE-STOREY BUILDINGS (ENG)*

[https://www.steelconstruct.com/wp-content/uploads/PROGRESS\\_Design\\_guide\\_final-version.pdf](https://www.steelconstruct.com/wp-content/uploads/PROGRESS_Design_guide_final-version.pdf)

Guide for the reuse of steel elements in single-storey constructions. The document describes different reuse scenarios and provides concrete guidelines for the design and calculation of structures based on salvaged steel elements.

Written by members of a project consortium within the framework of the PROGRESS project (PROvisions for GREater reuse of Steel Structures), funded by the RFCS (Research fund for coal and steel).

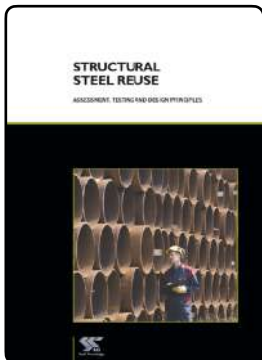
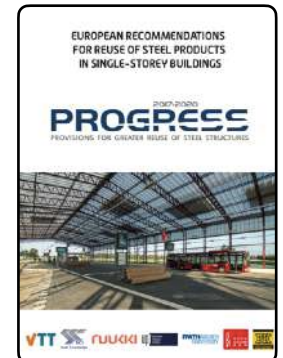

*STRUCTURAL STEEL REUSE / ASSESSMENT, TESTING AND DESIGN PRINCIPLES (ENG)*

[https://steel-sci.com/assets/downloads/steel-reuse-event-8th-october-2019/SCI\\_P427.pdf](https://steel-sci.com/assets/downloads/steel-reuse-event-8th-october-2019/SCI_P427.pdf)

A specific guide which establishes guidelines for the assessment of fitness for use, testing and design of reclaimed steel structures.

Produced by the Steel Construction Institute, UK, but applicable to countries that have adopted the Eurocode series of standards.

*STRUCTURAL STEEL ELEMENTS INTENDED TO BE REUSED IN STRUCTURAL APPLICATIONS (FR)*

<https://www.bbsm.brussels/wp-content/uploads/2021/06/annexe-20-WP6-fiche-produit-application-elements-de-structures-acier-de-reemploi-application-structurale.pdf>

Guide established within the framework of the BBSM project (Le Bâti Bruxellois Source de nouveaux Matériaux) with guidelines on the reuse of steel elements, where the guidelines as described in "STRUCTURAL STEEL REUSE / ASSESSMENT, TESTING AND DESIGN PRINCIPLES" are checked against the Belgian and Brussels context, and more specifically the general reuse protocols as established in the same project.



*DIAGNOSTIC AND PERFORMANCE EVALUATION METHODOLOGY FOR THE RE-USE OF STEEL FRAMING ELEMENTS (FR).*

Fondation Bâtiment Énergie (FBE), 2020.

<http://www.batiment-energie.org/doc/70/FBE-ECB-enjeu-A-ossature-V9.pdf>

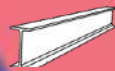

**Availability**

HEA, HEB and IPE profile beams, and to a lesser extent IPN and HEM, are commonly found in small and medium quantities on the reclamation market, mainly from demolition contractors who also have a stock of reclaimed materials. As an indication, the following table gives an idea of the availability of reclaimed steel beams (elements of the same type, of variable length, ~ 4 to 6 m):

Frequent	1 - 5 elements
Occasional	5 - 20 elements
Rare	20 - 100 elements

Often, large quantities of reclaimed beams are taken directly and sold from the deconstruction sites in order to limit the costs associated with transport and storage. It is therefore advisable to make contact fairly quickly (at the start of the project) with specialised companies in order to maximise the chances of coming across an available offer.

**Find specialised businesses**

salvoweb.com      opalis.eu

**Indicative prices (excl. tax)**

The price of re-used steel elements can fluctuate significantly depending on the development of the raw material market (especially the demand for recycled steel). The table below provides an indication for various reclaimed beam profiles (price per linear metre, prices observed in 2021).

HEA profiles:	HEA 100 : 18 €/ml HEA 200 : 40 €/ml HEA 300 : 75 €/ml
HEB profiles:	HEB 180 : 50 €/ml HEB 220 : 70 €/ml HEB 300 : 120 €/ml
IPE profiles:	IPE 120 : 10 €/ml IPE 240 : 26 €/ml IPE 360 : 50 €/ml

**Hazardous substances and precautions**

	A <i>lead</i> diagnosis may be necessary to detect the presence of old anti corrosion lead coatings (red lead) on the steel beams. Theoretically, red lead was banned in Europe around 1990. The diagnosis can be carried out either using a commercially available lead test kit, or by sending a sample of the paint to the laboratory or by having this test carried out by a professional. In this case, it is strongly recommended to strip and/or repaint using a specialised operator. It is strongly advised against using a heat gun, sander or sandpaper to remove lead paint. Chemical stripping will be preferred, with adequate health and environmental provisions.
	The reclaimed steel beams may have been coated with <i>asbestos</i> present in the old fire protection flockings. It is therefore advisable to remove the beams after the asbestos removal work, and in all cases, to inquire about the asbestos diagnosis if available.

**Embodied carbon (Cradle to gate - production A1-A3)**

	kg CO <sub>2</sub> eq./kg
INIES database (FR)- (CTICM collective data)*	1.41
INIES database (FR)- Generic data **	4.76
IBU database (DE) - individual data (EPD bauforumstahl e.V.) ***	1.74
ICE database (UK) ****	1.55

\* Indicative value for 1 kg of load-bearing steel beam element (column, girder, girt, joist, etc.) or structural element (purline, constituent element of a metal truss, etc.), ensuring the performance prescribed in the project design phase, for a reference lifetime of 100 years, a Young's modulus (elasticity) equal to 210 GPa, and steel grades S235, S275, S355 and S460 (defined in standard NF EN 10025).

\*\* Indicative value for 1 kg of load-bearing vertical steel element as a frame element for a reference service life of 100 years.

\*\*\* Indicative value for 1 kg of structural steel (sections and plates). It covers steel products of grades S235 to S960 rolled into structural sections, merchant bars and heavy sheets.

\*\*\*\* Indicative value for 1 kg of hot rolled steel profile. Steel sections include I-beams, H-beams, wide flanged beams, and sheet piles.

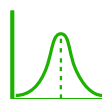

The production of new steel beams has a considerable environmental impact, in particular linked to the supply of raw materials from the mining industry and/or the recycling of metals, as well as to the energy required to supply the steel making process. From this point of view, reclamation is a particularly effective strategy for extending the life of a steel component. According to the sources, reusing 1 ton of steel prevents the equivalent production of ~ 1410 to ~ 4760 kg of CO<sub>2</sub> equivalent related to the manufacture of new steel (production phase only). This corresponds to the emissions caused by a small diesel car during a trip of ~ 8,400 to ~ 28,600 km.



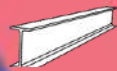

**Inspiration**

In 2021, the architectural firm Bauburo In Situ allowed the integration of steel structural elements into a project in Winterthur (Switzerland). Most of the beams (60 t) come from the deconstruction of a 15-year-old structure and other deconstruction sites (10 t). In the absence of precise information on the quality of the steel, the firm and engineers assumed the lowest quality, and used compensatory measures for the design of the structure (e.g. doubling the number of secondary beams). No tests were carried out and surface repairs and additional treatments were applied only occasionally. Fire resistance was obtained by casting the beams in concrete. The design of the new building was largely guided by the availability and dimensional characteristics of the batches recovered. The alterations to the beams were as minimal as possible, most of the connections were used as is. © Martin Zeller, Baubüro in situ ag (<https://www.insitu.ch/projekte/196-k-118>).



Beam reclamation



Beam reclamation



Beam reclamation

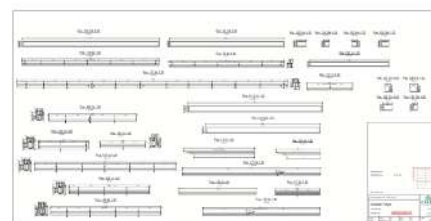

Inventory of elements



Installation of beams



Installation of beams



Installation of beams



**Disclaimer**

This sheet is intended for designers, specifiers and other members of construction project teams wishing to reuse this building material or product. It is part of a collection of sheets aimed at bringing together the available information to date that is likely to facilitate the reuse of building materials and products.

This sheet has been produced by Rotor vzw/asbl within the framework of the Interreg FCRBE project - Facilitating the Circulation of Reclaimed Building Elements, supported by the entire project partnership. Sources of information include the experience of reclamation dealers and involved project partners, lessons learned from exemplary projects, available technical documentation, etc.

The sheets have been produced between 2019 and 2021. As the reclamation sector is evolving, some information, notably regarding pricing and availability, may change over the time. When the text refers to European standards, it is up to the project team to refer, if necessary, to their national implementations and local specificities.

It is important to note that the information presented here is not exhaustive or intended to replace the expertise of professionals. Specific questions are always project related and should be treated as such.

The complete collection of sheets (including the introductory sheet) is freely available from different reference websites (a.o. [opalis.eu](http://opalis.eu), [nweurope.eu/fcrbe](http://nweurope.eu/fcrbe), [futureuse.co.uk](http://futureuse.co.uk)).

Non-exhaustive directories of dealers in reclaimed building materials are available on [www.opalis.eu](http://www.opalis.eu) and [www.salvoweb.com](http://www.salvoweb.com).

---

Interreg FCRBE partnership: Bellastock (FR), the Belgian Building Research Institute / BBRI (BE), Brussels Environment (BE), the Scientific and Technical Center of Building / CSTB (FR), Confederation of Construction (BE), Rotor (BE), Salvo (UK) and University of Brighton (UK).

The information contained in this document does not necessarily reflect the position of all the FCRBE project partners nor that of the funding authorities.

Unless explicitly stated otherwise, the content of these sheets is credited in the Creative Commons Attribution NonCommercial – Share Alike format (CCBY-NC-SA).



Unless explicitly stated, the images used in this document belong to © Rotor vzw/asbl or © Opalis. Any other image has been the subject of a systematic request for authorisation from their authors or rightful owners. When this request has not been answered, we assumed that there were no objections to the use of the image. If you feel that this interpretation is unreasonable, please let us know.



### Material description

**Barn wood, more commonly referred to as “barnwood”, is a classic on the reclamation market. According to several specialist suppliers established in Belgium and the Netherlands, this product has been gaining popularity since the early 2000s. The term “barnwood” commonly refers to wooden planks resulting from the dismantling of old agricultural constructions (referred to broadly as “barns”), mainly imported from Eastern Europe and North America. Having become particularly stable and resistant, this wood, marked by the passage of time and bad weather, is particularly well suited to reclamation for façade cladding (exterior cladding), wall cladding (interior panelling) and the design of certain room furnishings.**

Some batches are of a historical character. It is not uncommon for them to come from trees that have been felled in the primary forests of Europe and America. In some cases, the barns from which they came have played an important role in local history. In general, importers of barnwood are in direct contact with local demolishers, but the conditions under which dismantling takes place are not always transparent.

The name “barnwood” is sometimes used by some suppliers to refer to other types of wood planks with an aged appearance, such as floors from old French houses, used scaffolding planks, wood from American fruit crates, pallets or even railroad sleepers. In general, these are also quality woods, but their original characteristics and uses may differ from those of barnwood, which may have implications for possible new uses. In case of doubt about the origin or the conditions under which the elements were disassembled, it is recommended to contact the supplier for further information.

By nature, the original batches are generally made up of boards with heterogeneous characteristics. The quality of the sorting and treatments offered depends heavily on the supply chain and the operations supported by professional suppliers. The batches offered for sale are generally distinguished by the following characteristics:

→ *Geographic origin.* Unlike other parts of the world, Western Europe has partially lost interest in timber construction over the past century. Therefore, much of the barnwood available on the reclamation market is imported from more distant regions, notably Eastern Europe and North America. The Alpine region also has a specific market.

→ *Species.* Barnwood imported from North America is often very old (100-150 years or more) and consists mainly of American white oak, elm or other coniferous species (yellow pine, hemlock, redwood, red cedar, etc.). The boards dismantled in Eastern Europe and the Alpine region are generally over 50 years old and are most often made of coniferous wood (pine, spruce) or, more rarely, of European oak. Most of the time, the batches offered for sale consist of boards of the same species.

→ *Original application.* The boards are generally sorted during dismantling based on their original application (exterior cladding, interior panelling, floors, etc.) and grouped according to their appearance.

→ *Dimensions.* Very variable according to the batches but also between the boards of the same batch. Typical dimensions are in the order of 15 - 50 mm thick, 100 - 400 mm in width and 0.8 - 5 m in length - although some items have dimensions that deviate from these indicative measurements. More or less pronounced typical deformations (warped or distorted boards) can be observed. Some suppliers carry out sawing, planing, edging, etc. to give more uniform dimensions to the boards in a batch.

→ *Appearance.* For decades, wood has been exposed to intensive use and changing climatic conditions, which gives its surface a very particular and unique patina: subtle differences in colour, traces of previous paint or stain, traces of nails and of hardware, presence of knots and light cracks, accentuation of wood grooves, dull edges, etc.

→ *Finishing treatment.* For many applications, barnwood does not require any treatment. However, some suppliers offer brushing, sanding, planing, sandblasting services, etc. potentially useful for some applications.



Variability of barnwood planks

**Material reclamation**

Since it is mainly imported, barnwood is mainly available from specialist dealers and can sometimes supplement the offer of new timber dealers. The involvement of professionals ensures the smooth running of the following operations:



Source: Pixabay

→ **Dismantling.** Even if they do not carry out this operation themselves, professional suppliers usually put in place the necessary conditions for a supply of carefully disassembled quality boards. Most of the time, dismantling barnwood is done manually in order to preserve the integrity of the elements. A first step in selecting the elements usually takes place on site. Wood with significant defects (rot, traces of insects, large cracks, deformations, etc.). The presence of knots is usually not an exclusion criterion. The boards can also have the nails removed and be grouped together in batches based on their original application (cladding, panelling, flooring), their respective dimensions and their appearance.

→ **Sorted by the supplier.** Certain specialized suppliers carry out a second sorting on the batches that they import, based on the same criteria outlined above. In particular, some check for the presence of nails and other metal elements using a metal detector. This point of attention is essential to avoid damaging the tools necessary for a possible subsequent transformation.

→ **Drying.** According to the hygrometric state of the wood. The elements are generally dried naturally in a shed, taking the necessary storage arrangements (spacing between the elements, no contact with the ground, ventilation, heating, etc.). Artificial kiln drying can be done in some cases in order to reduce the humidity level to around 12%. The objective is, on the one hand, to ensure that the timber deforms little after installation (depending on the requirements of the application), on the other hand, to eliminate insects and fungi that would still be present in the boards.

→ **Operations.** Depending on the specifications specific to each project, the batches can be delivered raw or go through certain specific operations. These have repercussions on the price but make it possible to obtain a product perfectly suited to the requirements and specificities of its new use.

- **Superficial cleaning:** with water or by light mechanical brushing, in order to preserve the patina.
- **Sanding and sandblasting:** these operations can strongly affect the patinated layer.
- **Planing:** some suppliers offer it in order to obtain batches of boards of identical thickness. Planing is generally carried out on the non-patinated side.
- **Edging:** in order to obtain boards with a uniform width. The blunt appearance of the original edges disappears during this operation.
- **Sawing:** in order to obtain boards of uniform length or to eliminate unwanted sections.
- **Machining:** altering the boards' profile in order to correspond to the needs of the installation. The machining can consist, among other things, in providing the boards with a system of grooves and tongues to facilitate assembly, in setting up a trapezoidal profile for horizontal exterior cladding, in chamfering the edges, etc.
- **Preservation and impregnation treatment:** in order to optimize the durability of timber outdoors and/or give it fire-retardant, oil-repellent and water-repellent properties. Several processes coexist, for example soaking, sprinkling, brushing, in autoclave, heat treatment, etc. They are governed by standards (or technical opinions) and use recommendations. This operation can, to some extent, affect the original appearance and patina. Professional advice is recommended, especially if the wood has undergone this type of treatment before or if a topcoat is present. He will also be able to inform you about the possible toxicity of the products.

- **Finishing:** the wood can be left as it is or receive a finishing coat (varnish, waxes, oils, stains, paint, etc.)

→ **Storage.** The boards are stored horizontally and stacked on pallets, properly strapped in and protected from external moisture. Good ventilation and a heated environment help to control the humidity of the wood.

→ **Transport and delivery.** All necessary precautions must be taken during transport and delivery (strapping, means of handling, protection against rain, loading, etc.).



Machining of boards to obtain a tongue/groove assembly profile



Storage of batches of barnwood planks

**Truly Reclaimed Label**

As part of the European FCRBE project, to which these sheets are annexed, the organization SALVO Ltd. (UK) is working on the development of a "Truly Reclaimed" label, making it possible to certify the authentically recovered origin of materials (as opposed to artificially used materials). This label should see the light of day very soon for reclaimed wood products.





**Applications and installation**

**Reclaimed barnwood lends itself to a wide variety of applications: exterior cladding, interior panelling and furniture design. Given the strong heterogeneity of the batches of barnwood planks, their reclamation as floorboards is not particularly recommended, unless major transformations of the material are planned to meet the requirements relating to this application. For more information on reclaimed floors, please refer to the dedicated sheet.**

Leaving some latitude on the dimensions, texture, colour of the wood and all the non-essential characteristics often makes it easier to find a batch on the reclamation market. This approach generally requires adopting more flexible design and installation strategies, which make it possible to highlight the heterogeneity of the batches while respecting the essential requirements. For example: laying as free-length cladding, laying as panelling of varying thickness, etc.

Despite their extensive knowledge of the materials and the valuable advice they can give, barnwood dealers generally do not certify all of the characteristics of the items they supply. On the other hand, some provide guarantees on aspects such as the type of wood delivered, the dimensions of the elements, the maximum humidity level, the condition of the wood (without metal parts, mould, cracks, etc.) or even on its origin (some resellers thus affix the *FSC recycled* label - or an equivalent - which certifies that the wood comes from the dismantling of buildings and not from the cutting of trees).

As a general rule, the choice of boards must take into account the expected stresses (see "characteristics and fitness for use"). It is therefore advisable to refer to the standards of use of the products (for example EN 14915: Wood panelling and cladding - characteristics, requirements and marking), to the rules of practice in force and to the installation standards. By way of example, the points of attention relating to these applications are:



© Samuel Defourny

→ *For cladding use*

- The wood species must have natural durability characteristics compatible with outdoor use or be treated appropriately (preservation, heat treatment, etc.).
- The boards are laid horizontally or vertically, with a suitable profile limiting water stagnation, for example: straight profile for vertical openwork installation, "tongue and groove" profile for closed installation, trapezoidal profile (dual slope) for horizontal openwork installation, etc. In general, the vertical slats drain rainwater more quickly. The design details are also very important in order to avoid water traps (roof overflows, butt jointed boards, minimum distance to the ground, etc.).
- Barnwood batches often consist of boards of varying dimensions which may have certain deformations (buckling, warping, etc.). While it is generally possible to adapt installation by grouping boards of similar width and thickness on the same line, it can be more complicated to work with strongly deformed variations. One solution may be to demand precise dimensional characteristics or to provide for a transformation of the material (planing, edging, machining, etc.).
- In general, the wood intended for cladding must have a minimum thickness of 15 to 18 mm.
- To avoid subsequent deformations, a maximum wood moisture content of  $15 \pm 3\%$  is recommended for installation.



© Samuel Defourny



© Samuel Defourny



Installation of 2600 m<sup>2</sup> of barnwood cladding from Eastern Europe, Institute of Botany of the ULg, Liège (BE) © André Warnier

<https://opalys.eu/fr/projets/linstitut-de-botanique-de-lulg>



- The other points of attention are similar to the design of new cladding: type of support (wood frame, masonry, etc.), single or double fixing frame, choice and size of battens, method of fixing and centre distance of battens, installation of drip edges at lintel level, junction of incoming and outgoing angles, edge junction, anti-rodent grid, nails and screws (ringed, stainless steel, galvanized steel, dimension, etc.), rain screen, air gap and ventilation, insulation from the outside, construction tolerances, specific maintenance, flame-retardant, water-repellent, oil-repellent finishing products or processes, etc.
- *For use in panelling and interior furnishings*
- Most types of wood are suitable.
- It should be ensured that there are no insects which could spread to other wooden elements. A visual inspection of the boards is recommended at the time of installation. For greater safety, it is also possible to demand dried boards, or even to provide an insecticide treatment.
- A maximum wood moisture content of  $10 \pm 3\%$  is recommended during installation in order to guarantee the dimensional stability of the boards. Acclimatisation of the boards before installation is recommended (1 to 2 weeks).
- For indoor use, care should be taken to ensure that the wood has not been treated or exposed to toxic substances during its previous use, particularly where there is a risk of food contact. In the absence of information on this subject, it is best to stick to the "precautionary principle". (see further on: Hazardous substances and precautions).
- In the event of applying a new topcoat (stain, varnish, etc.), it is recommended to use products that respect the environment and the indoor air quality.
- The reaction to fire class can be determined with regard to the type of wood and the thickness of the boards. Flame retardant treatments also make it possible to improve this characteristic.
- The other points of attention are: type of support, method of fixing, nails and screws (ringed, stainless steel, galvanized steel, dimension, etc.), air space and ventilation, construction tolerance, specific maintenance, fire-retardant, water-repellent, oil-repellent finishing products or processes, etc.

**Derivative product**

*Barnwood is sometimes used for the manufacture of calibrated multi-ply panels. Following a series of transformations, the old planks are assembled with new wood to obtain a hybrid product that combines the stability of the classic panel with the particular aesthetics of barnwood. These panels are generally well suited for furnishing design (making kitchens, doors, cupboards, drawers, etc.).*



*Barnwood veneer on plywood panel.  
© Rotor © Atmosphère Bois*



*Multi-species interior panelling with boards of variable dimensions.*

**Quantities**

*It is important to purchase a sufficient quantity of planks from the outset. As each batch has unique aesthetic characteristics, it is not certain that an identical model will still be available with a subsequent order. In general, for both cladding and panelling, it is advisable to order a surplus of 10 to 15% depending on the condition of the batch and the design strategy chosen. To increase the chances of meeting the offer available on the reclaimed market, the specifier can choose to split the batch with different models.*





**Characteristics and fitness for use**

The reuse of barnwood planks generally requires certain parameters to be mastered in order to comply with the requirements relating to the intended application. In the case of cladding and panelling, experience as well as normative documents (for example the harmonized standard EN 14915) and techniques relating to wood and new wood-based materials make it possible to highlight a series of characteristics and recommendations applicable to barnwood (table 2).

For ease of reading, the table 1 shows some relevant parameters for some common barnwood species.

Table 1: Characteristics of the most common types of wood used for solid wood flooring

Species	Durability class (1)	Sensitivity to insects (1)	Density [kg/m <sup>3</sup> ] (2)	Dimensional stability (3)
American white oak and European oak <i>Quercus spp., Quercus robur</i>	II - III	Sensitive	700	Moderately stable to poorly stable
Larch <i>Larix spp.</i>	III - IV	Sensitive	600	Moderately stable
Yellow pine <i>Pinus spp.</i>	III - IV	Sensitive	500	Stable
Scots pine <i>Pinus sylvestris</i>	III - IV	Not very sensitive	500	Moderately stable
Spruce <i>Picea abies</i>	IV	Sensitive	450	Moderately stable
Western hemlock <i>Tsuga heterophylla</i>	IV	Sensitive	450	Moderately stable
Californian redwood <i>Sequoia sempervirens</i>	II	Not very sensitive	400	Stable
Western red cedar <i>Thuja plicata</i>	II	Not very sensitive	370	Very stable

(1) This classification is only valid for heartwood and not sapwood (peripheral wood), for wood without protective treatment. In the case of barnwood previously used for cladding, it is very likely that all the sapwood has already disappeared. However, it is preferable to make sure of this by checking the batch or by inquiring about the previous use (see also "use class" below).

(2) For a reference humidity H = 15%.

(3) Ability of wood not to warp under the influence of variations in humidity and temperature.

Table 2: Other relevant characteristics to be assessed according to use and context

Characteristics	Comments
<b>Dimensional characteristics</b>	Closely linked to the type of wood, the drying and storage conditions, the degree of sorting of the elements, the transformations of the wood (edging, planing, etc.) and the uniformity of the batch. A visual or detailed examination can be sufficient to estimate it. If necessary, most suppliers are able to calibrate the width, length or thickness of the boards.  The actual dimensions of barnwood planks are influenced by swelling and shrinkage due to variations in moisture content.
<b>Geometry (flatness, bending, warping)</b>	These characteristics are closely linked to the degree of sorting of the planks and their original stress. A visual or detailed examination of the batch is often sufficient to estimate these aspects.
<b>Surface quality</b>	A visual or detailed examination of the batch is often sufficient to assess it. The quality of the surface must anticipate the desired degree of finish (raw, sanded, sandblasted, brushed, etc.) and acceptable aesthetic defects (knots, slight cracks, holes, etc.). The presence of traces of flaking paint must be assessed for interior applications or with a risk of food contact (see below Dangerous substances and precautions).
<b>Humidity level</b>	To avoid subsequent deformations, barnwood must be installed at a defined balanced moisture content (H = 15 ± 3% for cladding and H = 10 ± 3% for panelling). This parameter essentially depends on the drying and storage conditions of the wood. A check can be carried out by means of a moisture meter.





Characteristics	Comments
<b>Natural durability</b>	This characteristic evaluates the natural resistance of wood to attack by fungi. It is assessed according to the species and the type of wood (sapwood or heartwood), and makes it possible to determine the use class of barnwood planks. Under certain conditions, it is possible to increase the natural durability by means of preservation treatments adapted to the species, the specificities of the reclaimed material and the intended use. In this case, it is "conferred" durability.
<b>Use class</b>	The use class of the wood determines its appropriate uses (see table 3). The harmonised European standard EN 460 thus defines five classes of use of wood and the associated biological risks, and recommends the possible application of an adequate protective treatment according to the use and the class of natural durability of the wood used (see standards EN 350-2 and EN 335). For example, oak, californian red-wood or western red cedar (durability class 2) are ideal for façade cladding without additional preservation treatment.

Table 3: Classes of use and associated biological risks

Usage class	General use	Biological risks		Natural durability class of wood				
		Insects	Fungi	I	II	III	IV	V
1	Indoors, in the dry	Yes	No					
2	Indoors, or under shelter, not exposed to bad weather. Possibility of water condensation	Yes	Low					
3	Outside, above ground, exposed to bad weather	Yes	Yes					
4	Outside in contact with the ground and/or fresh water	Yes	Yes					
5	Immersed in salt water on a regular or permanent basis	Yes	Yes					

Treatment not necessary  
Treatment is recommended  
Treatment is necessary



Re-use of 800 m<sup>2</sup> of barnwood for exterior cladding and interior panelling. Quay01 (K-nal), Brussels (BE) © Jean-Paul Hermant architectes  
<https://opalis.eu/fr/projets/bardage-quay01-k-nal>



Barnwood cladding for a home and guest rooms (Cerftitude) (BE). © Benoit Lanis. Architecte: Atelier 4/5.  
<https://opalis.eu/fr/projets/cerftitude>



Characteristics	Comments
<b>Susceptibility to insects</b>	Some species of wood are more susceptible to insect attacks. It is advisable to check the condition of the boards before their installation, in order to avoid the risk of infestation and spreading to other wood-work. Artificially dried planks are less likely to be infested. If necessary, there are specific preservation or finishing treatments.
<b>Wood stability</b>	This performance characterizes the way in which wood behaves when subjected to significant variations in humidity. This notion integrates the importance of deformations ("wood movement") and the speed at which they take place. A stable wood species is likely to be more suitable for applications subject to large variations in humidity (see table above). However, having already worked a lot during its previous use, with barnwood it is commonly accepted that the impact of this parameter can be put into perspective, whatever the species. Design and installation details are also to be considered (sufficient clearance between the boards, air gap, dry wood, etc.)
<b>Mechanical performance</b>	The in-depth evaluation of mechanical performance is relevant in case of high static and/or dynamic loads. This evaluation is done on the scale of the construction system and not just the boards. This should be taken into account when designing highly stressed cladding.
<b>Water vapour permeability</b>	Not applicable if there is an air space between the panelling/cladding and the wall. Otherwise the water vapour resistance factor can be deduced from the density of the wood under consideration (see values tabulated in standard EN ISO 10456).
<b>Sound absorption</b>	This characteristic, relevant in interior use, is influenced by the shape and finish of the boards. The sound absorption coefficient can be assessed through tabulated values given in standard EN 14951.
<b>Thermal conductivity</b>	Relevant characteristic for indoor use only. Lambda ( $\lambda$ ) thermal conductivity (in W/(mK)) can be assessed using tabulated values from EN ISO 10456. It is essentially a function of the density and humidity of the wood.
<b>Reaction to fire</b>	<p>Specific requirements for the reaction to fire are determined by national regulations. These requirements depend, among other things, on the use of the premises (for example: private or community housing, emergency exits, terraces on flat roofs, etc.), on the height of the building (for the façade cladding) but also on the ability of users to evacuate the premises in the event of fire (senior citizens' residence, hospital, etc.). It is therefore important for the specifier to meet regulatory requirements in terms of reaction to fire by determining the materials and their method of implementation, with regard to the intended use.</p> <p>According to a European resolution (Resolution 2006/213/EC), the reaction to fire class D-s2, d0 is assigned without additional testing to all solid wood exterior cladding with a minimum average density of 390 kg/m<sup>3</sup> (measured according to a reference humidity) and the minimum thickness of which is 18 mm.</p> <p>The influence of a preservative treatment against biological attack or any other finishing treatment must also be taken into account. If necessary, the reaction to fire performance of treated and untreated wood panelling and cladding products should be tested and declared according to EN 13501.</p> <p>Regarding barnwood, fire retardant treatments improve the reaction to fire and reduce their contribution to a conflagration and fire propagation (for example vacuum/pressure impregnation with fire retardants suitable for exterior or interior applications make it possible to obtain the reaction to fire class B-s1, d0)</p>
<b>Toxicity</b>	Barnwood planks may have been treated with toxic products or have been in contact with hazardous substances during their use. Most of the time, even if it is possible to visually detect the presence or absence of preservative and finishing treatments, it is generally more complicated to determine the exact nature of the substances present. Laboratory tests make it possible to identify and assess the dangerousness of any contaminants present. The toxicity of some of these contaminants may have dropped drastically after several years in service. In the absence of information on this subject, it is best to stick to the "precautionary principle" or likely to interact with food and/or people, for interior applications.



**Availability**

Barnwood planks are currently enjoying a certain notoriety. However, their availability depends on the quantities required. As an example:

Frequent	0 → 100m <sup>2</sup>
Occasional	100 → 250m <sup>2</sup>
Rare	250 → 500m <sup>2</sup>

For particularly large orders, some suppliers may need time to assemble different batches. In this case, it is also probable that the boards have various origins.

**Indicative prices (Excl. tax)**

Random sampling of the reclamation market in Western Europe (Belgium, France, Great Britain and the Netherlands) made it possible to extract some indicative prices. These vary depending on the models, condition and quantities needed. Some observed prices:

→ *North American barnwood*

- Oak: 80 - 170 €/m<sup>2</sup>
- Softwood (pine, hemlock), edged + brushed: 80 €/m<sup>2</sup>

→ *European barnwood*

- Oak: 65 - 100 €/m<sup>2</sup>
- Oak, edged: 75 - 110 €/m<sup>2</sup>

- Soft wood (resinous), raw: 35 - 45 €/m<sup>2</sup>
- Soft wood, edged + brushed: 45 - 60 €/m<sup>2</sup>
- Soft wood, brushed + tongue and groove: 60 - 100 €/m<sup>2</sup>

These prices correspond to dried (H = ~ 12%) and untreated boards. Long boards are sometimes more expensive.

**Find specialised businesses**

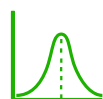

Assessing the impact of reclaimed timber construction products on global warming is complex and difficult to generalise. The general principle is that construction timber can confine biogenic carbon. Reclamation is therefore a way of preserving these carbon stocks and preventing it from being released into the atmosphere (which would be the case if the wood was incinerated, for example). The overall environmental assessment of a reclaimed wooden element must, however, also take into account aspects such as the origin of the product and the distance travelled, the use of preservation treatment, etc. For more information, it is advisable to consult the specific paragraph devoted to this question in the introductory sheet.

**Hazardous substances and precautions**

Barnwood planks may have been treated with toxic products or have been in contact with hazardous substances during their use. Most of the time, even if it is possible to visually detect the presence or absence of preservative and finishing treatments, it is generally more complicated to determine the exact nature of the substances present. Lead, copper, chromium, arsenic and PCP are some of the hazardous substances that can be found in barnwood planks. Their concentration in wood, their effectiveness and their residual harmful power are difficult to estimate without implementing specific laboratory tests. In the absence of information on this subject, it is best to stick to the "precautionary principle" or likely to come into direct contact with food and/or people for interior applications. In addition, sawing, planing, sanding, etc. must be carried out by taking the appropriate safety measures (personal protective equipment, dust extraction systems, waste disposal, etc.).

	<p>A <i>lead</i> diagnosis may be necessary to detect the presence of old lead paints on the planks. This diagnosis can be carried out either using a commercially available lead test kit, or by sending a sample of the paint to the laboratory or by having this test carried out by a professional. In this case, it is strongly recommended to strip and/or repaint using a specialised operator. It is strongly advised against using a heat gun, sander or sandpaper to remove lead paint. Chemical stripping will be preferred, with adequate health and environmental provisions. An alternative to stripping can be to apply a new top coat so that the old coat of paint is completely encapsulated.</p>
	<p>For more information on the subject, you can consult the following document written by INRS which covers the main wood treatment products (constituents, dangers, uses, preventive measures): <a href="https://www.inrs.fr/medias/html?refINRS=ED%20981">https://www.inrs.fr/medias/html?refINRS=ED%20981</a></p>



**Disclaimer**

This sheet is intended for designers, specifiers and other members of construction project teams wishing to reuse this building material or product. It is part of a collection of sheets aimed at bringing together the available information to date that is likely to facilitate the reuse of building materials and products.

This sheet has been produced by Rotor vzw/asbl within the framework of the Interreg FCRBE project - Facilitating the Circulation of Reclaimed Building Elements, supported by the entire project partnership. Sources of information include the experience of reclamation dealers and involved project partners, lessons learned from exemplary projects, available technical documentation, etc.

The sheets have been produced between 2019 and 2021. As the reclamation sector is evolving, some information, notably regarding pricing and availability, may change over the time. When the text refers to European standards, it is up to the project team to refer, if necessary, to their national implementations and local specificities.

It is important to note that the information presented here is not exhaustive or intended to replace the expertise of professionals. Specific questions are always project related and should be treated as such.

The complete collection of sheets (including the introductory sheet) is freely available from different reference websites (a.o. [opalis.eu](http://opalis.eu), [nweurope.eu/fcrbe](http://nweurope.eu/fcrbe), [futureuse.co.uk](http://futureuse.co.uk)).

Non-exhaustive directories of dealers in reclaimed building materials are available on [www.opalis.eu](http://www.opalis.eu) and [www.salvoweb.com](http://www.salvoweb.com).

---

Interreg FCRBE partnership: Bellastock (FR), the Belgian Building Research Institute / BBRI (BE), Brussels Environment (BE), the Scientific and Technical Center of Building / CSTB (FR), Confederation of Construction (BE), Rotor (BE), Salvo (UK) and University of Brighton (UK).

The information contained in this document does not necessarily reflect the position of all the FCRBE project partners nor that of the funding authorities.

Unless explicitly stated otherwise, the content of these sheets is credited in the Creative Commons Attribution NonCommercial – Share Alike format (CCBY-NC-SA).



Unless explicitly stated, the images used in this document belong to © Rotor vzw/asbl or © Opalis. Any other image has been the subject of a systematic request for authorisation from their authors or rightful owners. When this request has not been answered, we assumed that there were no objections to the use of the image. If you feel that this interpretation is unreasonable, please let us know.

**Material description**

**Solid clay bricks (called "bricks" in the rest of the document) are obtained by firing moistened clays, mixed, shaped by pressing or stretching, moulded or pre-formed, dried and finally fired at a temperature of 850 to 1200° C. It is a craftsman or industrially manufactured ceramic material, the technical properties of which depend essentially on the composition of the mixture, the firing temperature and the technical skill used in its manufacture. Although mechanised from the 19th century, the manufacturing process has remained similar for over 6000 years. Until World War II, the majority of bricks were produced regionally, from local clays.**

Under normal conditions, bricks are traditionally used for the construction of load-bearing or decorative masonry, protected or not. Clay bricks generally exhibit very good durability. However, external factors can affect their properties during their use: structural constraints, bad weather, various pollutants, etc.

*Protected and unprotected masonry*

*Protected masonry is a wall which is not exposed to water and which is not in contact with soil and groundwater. This is the case for interior walls and exterior walls covered with an appropriate coating or protected by cladding.*

*Unprotected masonry is a wall exposed to rain and frost and which may be in contact with soil and groundwater. This is the case for exterior walls without protection or with limited protection (for example, a thin layer of plaster).*

*Whether or not it is protected is independent of the structural role (load-bearing or non-load-bearing masonry).*

A large part of the bricks present on the reclamation market were produced between 1800 and 1970 and mainly come from masonry walls with lime mortar (or other soft mortar). From 1970, the use of cement-based mortars made their reclamation more difficult, if not impossible. Other factors such as the use of hollow or perforated bricks, which are lighter, as well as the lowering of the firing temperature of the bricks due to the oil crisis of 1973 limited their potential for reclamation.

Despite this, large quantities of reclaimed solid bricks from dismantling are available from professional suppliers, mainly in Belgium, Great Britain and the Netherlands. There is a great diversity of models there, which often reflect historical regional specificities. Several criteria make it possible to distinguish reclaimed bricks:

→ *Production methods, including:*

- Hand-moulded (also called "handmade"). These bricks are generally rough and uneven in appearance.
- Mechanically moulded: same as the previous ones, with a more or less pronounced depression at the level of the installation face ("Frog" in the United Kingdom).
- Stretched (or extruded, mechanical, "wire cut"): clay is pressed through a mould into a continuous mass and cut into regular sized pieces. The appearance of these bricks is often smoother and more even.

→ *Origin.* Reclaimed bricks are often referred to by the region where they were produced (e.g. Beersesteen and Scheldesteen in Belgium, IJzelsteen in the Netherlands, Accrington in Great Britain, etc.) or by the type of kiln in which they were fired (e.g. Paepsteen, Klampsteen, Veldovensteen, portable kiln, etc.).

→ *Formats.* There is a wide variety of models, usually associated with a manufacturer and/or a region of origin. For example: rijnformaat (BE) (180 × 85 × 50 mm), derdeling (BE) (160 × 80 × 40 mm), boerkes (BE) (170 × 90 × 65 mm), waalformaat (BE) (210 × 100 × 50 mm), Spaanse Moef (BE) (210 × 50 × 100 mm), Imperial bricks (UK) (225 × 110 × 65 mm), etc.

→ *Appearance and colours.* Depending on the model, reclaimed bricks have a smooth or rough texture, with straight or rounded/blunt edges. Solid bricks are not perforated, but may have more or less pronounced recesses (in the case of mechanically moulded bricks, for example). The colours are often yellow, orange, red, brown, purple, grey or blue. In some cases, the faces or ends may show traces of paint. Slight traces of residual mortar or sand may also remain.

*The firing of bricks in traditional kilns was less uniform than in modern kilns. A batch resulting from the same firing could therefore have bricks with different characteristics depending on their position in the kiln and their exposure to heat. The better fired bricks exhibited darker colours and better mechanical performance (frost resistance, compressive strength, etc.). They were intended for load-bearing and unprotected masonry uses. Less fired bricks were intended for less demanding uses, such as interior partitions. This sorting was based on the know-how of bricklayers and masons. Nowadays, most new bricks are fired in tunnel kilns which ensure a more even heat distribution. Their performance is determined by means of standardised tests.*



Boomse Klampsteen hand moulded reclaimed brick (BE)



Beersesteen-type extruded reclaimed brick (BE)



Accrington type mechanically moulded reclaimed brick (UK)



Varieties of reclaimed bricks on the Belgian market. From g. to d., from the top: 1. (Boomse) Handmade Klampsteen or Klinkaard (rijnvorm). 2. (Boomse) Klampsteen or Klinkaard handmade (derdeling). 3. Papesteen (rijnvorm). 4. Papesteen (derdeling). 5. Blue papesteen (derdeling). 6. Beerse steen or machinale Klinkaard (rijnvorm). 7. Beerse steen or mechanical Klinkaard (Beerse 65). 8. Beerse steen or mechanical Klinkaard (waalfmaat). 9. Handmade Poldersteen (moef) or Brugse moef/poldersteen. 10. Damse Poldersteen (moef) or Damse (abdij) moef, Kuststeen. 11. Spaanse moef. 12. Brusselse Klampsteen. 13. Scheldesteen. 14. Scheldesteen (dik). 15. Veldovensteen.

Currently, reclaimed bricks are mainly used for decorative non-load-bearing masonry, indoors or outdoors. Some models are very popular. There are also cases of use of reclaimed bricks for load-bearing masonry. Reclaimed brick is also commonly used for landscaping.

In this document, we do not deal with clay paving bricks, refractory bricks, hollow, perforated or honeycomb bricks, enamelled or coated bricks, or sand-lime masonry products.

**Tip**

Do not confuse solid masonry bricks with paving bricks. Despite strong similarities, these are produced from a particular clay composition and high firing temperatures. They are naturally very resistant to frost, pressure, wear and aggressive agents such as road salt and cleaning products. For more information, see the dedicated sheet.



Paving bricks

**Do not mix up...**

Some contemporary bricks are called “manual” in reference to their appearance, although they have actually been pressed by machines. These days hardly any bricks are truly hand-moulded in Europe. The success of reclaimed bricks has led some manufacturers of new bricks to produce bricks imitating the appearance of old bricks using artificial ageing techniques: knocks on the edges, pounding, false traces of mortar, etc. So check the origin of the bricks with the supplier!

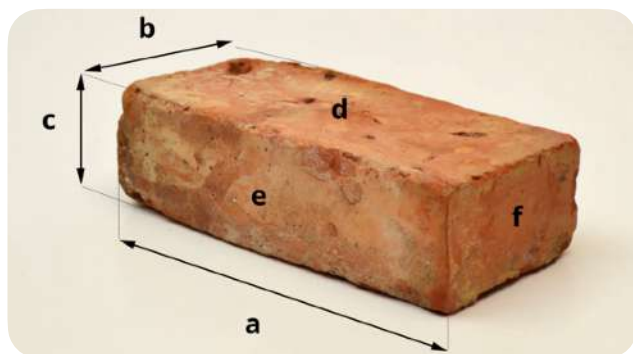

- a. Length
- b. Width
- c. Height (thickness)
- d. Laying face
- e. Face
- f. End

“Anatomy” of a solid masonry brick





**Material reclamation**

**The reclamation of bricks must always be done in compliance with the safety rules applicable to demolition works. If the bricks do not find a new use directly on site, they can be sent to professional reclaimed channels. Often, operators who salvage bricks are also active as demolition contractors. Trade terms can then be negotiated depending on the value of the bricks.**

→ *Dismantling test* (or expert opinion). In practice it makes it possible to ensure the feasibility and profitability of a removal. An “expert eye” generally makes it possible to estimate the interest of a batch based on plans, photos, historical documents or by an on-site visit. The focal points will be among others:

- the general condition of the batch and the method of installation (type of mortar, damage, etc.)
- Commercial interest (depending on model, quantity, salvage and resale potential, specific regional particularities, etc.)
- logistics arrangements (deadline, working time, handling, transport, etc.).

In order to more confidently determine the salvage potential of bricks and to estimate the rate of loss, a dismantling and cleaning test is usually performed on a sample of several dozen bricks.

*Limitations to the reclamation of bricks.*

*Certain factors can limit or even compromise the reclamation of bricks.*

- *Original applications* . Bricks found in stables (smell of ammonia), basement walls, foundations, cesspools, cisterns and chimneys are not salvaged because the permanent damage caused by the moisture and/or pollution during their working life prevent them from extending their life in a safe and correct manner.
- *Mortar* . Removal of leftover mortar is necessary to reuse the bricks. In general, soft mortars such as lime, ash, clay-based mortars and cement/lime bastard mortars are relatively easy to remove. Cement-based mortars and adhesive mortars, which have become widely used since the 1970s, make cleaning more difficult. These mortars are more resistant but also more adherent. Technically, their elimination is not impossible but, in practice, it is generally too expensive and affects the profitability of reclamation. In addition to the age of masonry, the two types of mortar can often be distinguished visually: lime mortars are lighter and often beige, cement mortars darker and grey.

→ *Removal*. Careful dismantling should aim to ensure the integrity of the bricks and a certain uniformity of the batches. First, the surface coatings (plaster, ceiling installations, etc.) are removed mechanically. Then the actual disassembly can be done manually or, for larger volumes, using a grapple crane, paying particular attention to ensuring that the bricks are laid smoothly on the ground or in a container. Even a drop from a low height can be enough to break a perfectly reusable brick. Bricks that break or spontaneously pulverize during dismantling are automatically discarded.

If the bricks to be dismantled show variations (for example, according to their exposure), it is recommended to list these and to make a precise distinction at the time of removal.

→ *Treatment*. Apart from cleaning up the mortar remains and qualitative sorting, reclaimed bricks generally do not undergo any treatment. Cleaning can be carried out on site or at a specialist. Removal of mortar remains or dirt (foams, etc.) is done manually or mechanically, brick by brick, using a hatchet, a chisel, a steel brush or a scraping machine or vibrating plates. In order to facilitate the installation of reclaimed bricks, only slight traces of surface mortar or thin layer of cement are tolerated. For this reason, hollow or perforated bricks do not lend themselves well to these operations and are therefore rarely reclaimed.



*Crumbling brick, unsuitable for reclamation*



*Variations in colour and appearance of old brick models*



*Traces of paint and slight remains of mortar*



*Demolition and reclamation on site. Renovation of the Tour A Plomb, Brussels. © BVDA - Bernard Van Damme Architecte*



*Manual cleaning of mortar remains*



*Mechanical cleaning of mortar remains*



## Solid clay brick

The bricks are sorted during cleaning according to a check:

- **visual:** the bricks are inspected and the items showing significant damage are rejected. Bricks can be irregular, but must have at least one face and one end in good condition. When paint remains are present on the surface of a brick, the opposite face or end must be in good condition. Bricks unsuitable for reuse because of their former use can often also be recognised visually (e.g. bricks with burn marks from old chimneys or fireplaces).
- **olfactory:** bricks emitting foul odours (ammonia, fuel oil, etc.) are eliminated.
- **auditory:** to check that a brick is intact, solid and non-porous, it can be tested by tapping lightly with a hard object or tool. A “dull” sound indicates an internal fracture, a “clear” sound means that the brick is unaltered. This rudimentary inspection is usu-

ally carried out by qualified personnel, who have long-standing expertise in the field.

- **mechanical:** the bricks are rubbed in order to check the porosity. A brick that is peeling is usually too porous.

The bricks are sorted by models, qualities, possible deterioration, colours and dimensions. The total proportion of bricks recovered depends on the condition of the original masonry. It is often in the order of 50 to 70 %. Bricks that break during disassembly and cleaning are largely unusable. However, it is possible to keep a small amount of half or three-quarter brick for the joints and angles, depending on the type of assembly planned during their reinstallation. Some professional suppliers are also able to deliver these incomplete formats.

→ **Complimentary tests.** A series of simple techniques can be deployed for in-depth diagnosis in situ.



◀ **Karsten's Pipette** is a simple test to estimate the water absorption of bricks. A glass tube filled with water is hermetically attached to the surface of the brick. A graduated scale indicates the amount of water that penetrates in a given time. © [Plate-Forme Maison Passive](#)



▲ The moisture content (water content) of bricks can be measured with a **moisture meter** or with a simple **carbide bomb** test. This measurement makes it possible to assess the porosity of the bricks. © [dmelaser.com](#)



◀ The **rebound hammer** (or **Schmidt hammer**) is a portable piece of equipment used to non-destructively estimate the strength/hardness of certain materials. An elastic impact force is sent to the material to be tested, the unabsorbed energy is then returned and quantified by the apparatus. An analysis of the data by means of charts or calibration curves then makes it possible to compare the samples to be tested. © [proceq.com](#)



▲ To a certain extent, the compressive stresses (and therefore the compressive strength in situ) can be estimated by means of a **flat cylinder**. This technique consists of making a groove in the masonry at the level of a horizontal mortar joint in order to insert a flat cylinder placed under pressure. However, this technique is not suitable for all types of mortars and the results should be interpreted with caution by experienced persons. © CSTC, *Guide pour la restauration des maçonneries: 1ère partie, Stabilité des ouvrages*, 2002



▲ **Indicator strips** are used to determine and quantify the presence of soluble salts in masonry (nitrates, chlorides, sulphates).

© [technichem.be](#)





## Solid clay brick

→ **Storage.** The bricks are ideally stacked in an offset manner, and stored on pallets (500 to 1000 pieces/pallet depending on the model). Complete pallets do not exceed 1 m in height and are shrink wrapped, to ensure their stability during transport and to protect them from weather and dust. When the bricks are cleaned and reclaimed on site, it is also possible to store them in piles on level, dry ground. It is essential to protect them from rain and rising damp from the ground, so that they are dry when re-installed.

→ **Transport and delivery.** The necessary precautions must be taken during transport and delivery in order to minimise breakage (strapped, shrink wrapped pallet, etc.).

It is advisable to involve specialised professionals to ensure the smooth running of these operations.

### Tip

*It is recommended to purchase a sufficient quantity of bricks from the outset. Each delivery of reclaimed bricks has a unique composition. The bricks of a subsequent delivery may therefore have different dimensions and colours.*



Storage of dismantled bricks before sorting and cleaning, at a professional dealer



Storage of sorted and cleaned bricks on covered pallets

### Reclaimed brick facing

*Some suppliers offer facing tiles made from reclaimed bricks. The original bricks are sawn lengthwise into pieces 25 to 40 mm thick. The edges are sold separately and their characteristic patina is retained.*



Facing bricks © [BCA matériaux anciens](#)



Showroom of a reseller of reclaimed bricks. Enhancement of the different models, with joints of varying nature and thickness



Facing bricks © [franck.be](#)



Facing bricks © [BCA matériaux anciens](#)

### Did you know?

*Danish reclaimed brick dealer Gamle Mursten has initiated a procedure to obtain CE marking for certain types of bricks common to the Danish market. To do this, an accredited European body was tasked with adapting the harmonised standards developed in the context of industrial production to the specificities of reclaimed products. This provided Gamle Mursten with clear guidelines for establishing a Declaration of Performance (DoP) for the most common types of reclaimed bricks. In addition to the commercial advantage associated with CE marking, this process allows construction professionals to have reliable data on certain characteristics of reclaimed bricks (for example: compressive strength, frost resistance, absorption rate, flexural and traction strength). An environmental declaration of their products (EPD) is also available.*



Mechanised sorting and packaging of reclaimed bricks © [Gamle Mursten \(DK\)](#)





## Applications and installation

**Reclaimed solid clay bricks are mainly used in masonry of protected or unprotected structures such as exterior façade claddings, interior wall cladding and partition walls. They can also be used in load-bearing masonry, exterior masonry (low walls, etc.), interior paving and decorative masonry. Their use is not recommended for exterior paving (for this use, refer to clay paving or terracotta clinkers).**

As a general rule, the choice of bricks must take into account the expected stresses (see § Characteristics and fitness for use) and urban planning regulations. Depending on the application, it is advisable in all cases to refer to the conception standards in use (e.a. EN 1996: Eurocode 6 for the design and calculation of masonry structure), to the European and national standards relating to the product (e.a. EN 771-1+A1, etc.), to the rules of practice in force and to the installation standards. According to the regulations in force, it is also necessary to take into account seismic, thermal and acoustic requirements, fire resistance, waterproofing, etc.

The reuse of a complete batch of reclaimed solid clay bricks in good condition is no different from that of new bricks. Broadly speaking, they raise the same points of attention, in particular: properties and condition of all the masonry elements (cavity wall, composite wall, fittings, wall ties, etc.), choice of mortar, joints, brick-laying, finish, climatic and meteorological factors, insulation, attachment and console system, safety factors during sizing, costs and installation times, etc.

Due to greater dimensional variability through their irregular surface, reclaimed bricks are often “wild bond” (or irregular) laid and with wide mortar joints (10 to 12 mm), but other solutions are possible, depending on the model. Glued installation is not recommended.

The integration of reclaimed bricks into load-bearing masonry requires compliance with mechanical requirements. In general, the mechanical performance of masonry depends on the nature of the elements, the type and thickness of the mortar joint and the resistance of the materials. In this regard, the choice of mortar must also take into account the characteristics of the bricks (porosity, initial water absorption, humidity level, specific weight, adhesion, etc.) and the requirements related to the masonry (climatic exposure, resistance, etc.).

### *Think reversible!*

*The use of a lime mortar or a bastard mortar (lime-cement), without resins or additives, facilitates future dismantling. This bonding method must be considered with regard to the application of the bricks, and requires special precautions during installation. For more information, refer to standard EN 998 (1-3): Definitions and specifications of masonry mortars. Some producers of new bricks are interested in the question of reversibility and offer solutions in this direction. Feel free to contact them.*

Once completed, several finishes are applicable to the masonry: sanding of the remains of paint and mortar present on the reclaimed bricks, application of a lime plaster/whitewash, or even according to requirements, application of a waterproofing coating.

To facilitate laying, the designer/specifier will take care to use batches with a certain degree of uniformity in terms of the following characteristics:

→ **Batch composition.** The batch must consist entirely of the same model of clay bricks. In most cases, professional suppliers offer batches of uniform bricks, but from different origins. In on-site reclamation, the characterization of the batches is carried out based on a detailed inventory of the products, in relation to their original application and their installation mode. This information generally makes it possible to define the potential risks and the criteria necessary for the distribution and uniformity of the batches with regard to the intended application. The focal points will be among others:

- **Brick Information:**

- Type, make, model, manufacturer, year of production, dimensions, technical sheet, visual appearance and possible deterioration, etc.

- **Original application information:**

- Type of work, year of construction, geographical location, specificities (seaside, roadside, mountain area, etc.)

- Types of application (protected, unprotected, facing, load-bearing wall, etc.) and location in the structure.

- Specificities (orientation of unprotected walls, foundations, insulated wall, interior vs exterior, foundation, stables, etc.)

- **Installation information:**

- Types of joints, mortars, fastening and fitting systems, water repellent treatments and injections against humidity, renovations, etc.

→ **Dimensions.** The dimensions of the bricks must be uniform. The dimensional tolerance will be determined by the designer/specifier according to the installation constraints. Generally speaking, the brick faces that are too irregular can be hidden by directing them towards the non-visible side of the masonry. For bricklaying requiring half bricks, the desired quantities should be specified. It is recommended to check in advance which types of bricks are available in which formats.

→ **Colour.** Variations in colour and appearance are frequent. In the case of reclaimed clay bricks, these variations are mainly due to the production method and the origin of the batches. Palletized bricks from professional dealers are generally mixed enough to obtain a good aesthetic result. In case of doubt, the different pallets can be mixed again during placement.

→ **Cleaning.** Despite thorough cleaning, surface mortar residues are inevitable, especially for hand-moulded bricks. The traces of cement mortar are often more visible. These can give an aesthetically interesting appearance to the wall. If necessary, it is possible to provide a finishing treatment a posteriori (e.g.: sandblasting, plaster/whitewash, etc.).



→ **Condition.** In addition to traces of mortar residues, reclaimed bricks may show minor alterations such as signs of surface wear, chips, cracks, craters, or light flaking, stains, traces of paint, remains of moss, traces of efflorescence, etc.

These deteriorations can influence the technical and aesthetic performances of the bricks, as well as their reinstatement, but do not constitute a major obstacle for reuse (see § *Characteristics and fitness for use*). It is up to the designer/specifier to define the degree of imperfection tolerated, according to the defined use and the installation conditions, by specifying the degree of acceptable alterations.

→ **Quantity.** Some suppliers may include a 5% surplus when the product is delivered if they are not able to guarantee the absolute uniformity of the characteristics mentioned above. This surplus can also be applied in the case of an on-site salvage scenario. To limit the risk of not finding the model, special attention should be paid to the quantities ordered.

Most professional suppliers are able to ensure that delivered batches meet these requirements. Generally, reclaimed building materials are sold as is. The conditions of sale may however contain special guarantees specific to the material. Some suppliers are able to indicate the origin of the material and/or provide documentation on the product purchased (for more information, see the introductory sheet).

Some models of old bricks are renowned for their excellent technical characteristics, linked in particular to the quality of the clays, to the firing temperatures (historically higher than that of today) and to the know-how of the old brick makers. The persistence of constructive works that are sometimes centuries-old (and even thousands of years) clearly attests to the durability of old bricks. Today, this largely empirical knowledge and based on a more direct relationship with the material, which is still found among many old brick specialists, struggles to gain recognition for its validity in the normative frameworks of the construction sector, based on a more statistical and depersonalised approach. The advice of specialists remains extremely valuable in choosing a brick model suited to the requirements of the intended use.

#### **Design tip!**

*To increase the chances of meeting the offer available on the reclamation market, the designer/specifier can choose to split large surfaces into smaller quantity batches, for example, by providing combinations of formats and patterns in the masonry. In this case, the compatibility of the models must be determined in advance, both at the technical level and at the design level.*



Reuse of brick modules. The Resource Rows.  
© Lendager Group (DK)

#### **Did you know?**

*An alternative to salvaging bricks “individually” has been explored by the Danish company Lendager Group. Their “Resource Row” project (2019) is a housing complex in which brick modules from several demolition sites have been integrated into the façade. The variations in pattern and orientation of the modules contribute to the unique character of the building.*



**Characteristics and fitness for use**

Most of the time, it is complicated, if not impossible, to simultaneously demonstrate all the technical performance associated with batches of reclaimed bricks. This is explained by a significant variability within the batches, in particular due to:

- the brick production process (heterogeneity of clay mixtures, variable and seasonal natural drying conditions, uneven heat distribution during brick firing, etc.).
- the unequal distribution of the stresses applied to the masonry of the same building during the life of the work. For example, local variability of exposure to frost and humidity, variability of mechanical or physicochemical stresses, etc. To a certain extent, it is possible to separate the elements at the time of removal based on

simple characteristics (e.g. masonry exposed and not exposed to frost and humidity, elimination of sensitive areas such as stables, tanks or foundations, etc.) but the degree of uncertainty generally remains at a more local level.

- the mix of supply sources. The suppliers of reclaimed bricks usually put together batches of similar bricks from different buildings. Bricks that have undergone different stresses are therefore mixed during the sorting and cleaning process.

This variability does not generally pose a problem for applications subjected to low stresses. It is even, in a certain respect, a factor allowing an increase in the quantities of reclaimed bricks.

On the other hand, reclaimed bricks are less suitable for applications for which a

great homogeneity of certain technical characteristics is essential (for example: compressive strength). In this case, the use of laboratory tests can provide answers, as long as the sampling is representative of the batch. Design strategies such as oversizing and robustness of details can also be an alternative to performing expensive tests.

The harmonised European standard EN 771-1+A1 defines the relevant characteristics (depending on the context) and the performance requirements to determine the fitness for use of new solid clay bricks. Although detailed for new bricks with identical intended use, these characteristics can also be useful in assessing the suitability of reclaimed bricks. The table below comments on these for exposed and unexposed, load bearing (L.) and non-load bearing (N.L.) masonry applications.

Characteristics	Exposed		Unexposed		Comments
	L.	N.L.	L.	N.L.	
<b>Density</b>					This parameter is commonly used for the calculation of the performance of stability, sound insulation, thermal insulation, fire resistance, water vapour permeability. It can be estimated simply by using scales and a meter, or it can be determined with precision in the laboratory.
<b>Dimensions (length, width, thickness)</b>	x	x	x	x	These characteristics are closely related to the degree of sorting and cleaning of the bricks. A visual or detailed examination of the batch is often sufficient to estimate them. In general, the degree of dimensional tolerance of reclaimed bricks is higher and is compensated by the use of thicker joints or by an adapted design (for example "wild" or irregular bond).
<b>Surface condition</b>	x	x	x	x	Ditto. Minor damage is not considered a defect as long as it does not prevent correct placement and affect the mechanical properties of the brick. The surfaces that may be coated must have sufficient roughness to allow the product to adhere.
<b>Structural integrity</b>	x	x	x	x	The structural integrity of bricks can be determined quite simply by means of visual or auditory tests.
<b>Porosity and water absorption</b>	x	x			<p>The porosity of used bricks varies considerably between models, ranging from very little absorbent to very absorbent. In general, the porosity is between 5 and 20%, mainly depending on the temperature at which they were fired. Porosity influences water absorption and the level of fouling. Water-repellent finishing treatments can limit this factor.</p> <p>The initial water absorption rate makes it possible to determine the good compatibility between a mortar and a brick, depending on the level of adhesion required. This characteristic is important for load-bearing masonry and exposed masonry subjected to horizontal loads (wind pressure, earthquakes, etc.)</p> <p>These parameters can be tested in the laboratory or estimated under in situ conditions ( see karsten pipette, moisture meter, carbide bomb ).</p>
<b>Frost resistance</b>	x	x			<p>In general, bricks which have been subjected to numerous freeze/thaw cycles without being damaged have already proved this aptitude. Therefore, special attention should be paid to the application and the original climatic zone, especially if the bricks are reused as unprotected masonry.</p> <p>In case of uncertainty, specific laboratory tests can be performed. In the absence of tests, bricks from protected masonry are not recommended for exterior applications.</p>





Characteristics	Exposed		Unexposed		Comments
	L.b	N.L.b	L.b	N.L.b	
<b>Fire resistance</b>	x	x			Fire resistance is assessed according to the construction system. It is determined according to the thickness and the characteristics of the various constituent layers. The basic rules in this area are given in standard EN 1996-1-2 (Eurocode 6).
<b>Reaction to fire</b>	x	x	x	x	Commission Resolution 2000/603/EC provides that masonry bricks with an organic matter content of less than 1.0% may be classified, without prior testing, in reaction to fire class A1. In case of uncertainty, bricks can be classified according to EN 13501-1.
<b>Compressive strength</b>	x	(x)	x	(x)	<p>This characteristic is particularly important in load-bearing masonry. The average compressive strength of a batch of reclaimed bricks can be determined in the laboratory, and then used for the calculation according to Eurocode 6. For information, the dispersion of the sampling results should not be too great. It is therefore advisable to work from batches of unmixed bricks.</p> <p>For non-load-bearing facing masonry, carried out according to the rules of practice, the compressive strength is generally not considered to be an essential criterion.</p> <p>To our knowledge, the tests carried out on several old models of reclaimed bricks result in a high compressive strength, mainly due to the high firing temperatures. Most suppliers of reclaimed bricks have a good knowledge of the models and their empirical mechanical properties. They can provide helpful advice.</p> <p>The compressive strength of masonry also takes into account the type of mortar used.</p> <p>This parameter can also be estimated in situ (<i>see flat cylinder technique</i>).</p>
<b>Flexural and shear bond strength</b>	(x)	(x)	(x)		These characteristics are relevant to assess where the masonry is subjected to horizontal forces (long spans of wall, wind pressure, seismic region) and particularly in the case of load-bearing masonry. They can be calculated from tabulated values according to the type of masonry element and the type of mortar (Eurocodes 6) or by laboratory tests (EN 1052-2 and EN 1052-3).
<b>Thermal properties</b>	x	x			<p>Relevant characteristics to assess whether bricks contribute to the thermal performance of the building envelope. Thermal values can be determined according to tabulated data (from density data), measurements, calculations, or a combination of the three. Refer to standard EN 1745 - Masonry and masonry products - Methods for the determination of thermal properties.</p> <p>Generally speaking, bricks, like most clay products, have relatively high thermal inertia which helps to regulate the temperature of the indoor climate.</p>
<b>Moisture expansion</b>	x	x			Clay products are generally dimensionally stable.
<b>Efflorescence</b>	x	x			<p>The appearance of efflorescence on the surface of used bricks is mainly caused by the transport of soluble components through the brick by rain.</p> <p>Most of the time, the exposed bricks have generally had time to evacuate their soluble salt content during their working life (beware of bricks subjected to sea spray). However, the exterior application of unexposed (interior) bricks or that have been in contact with the ground may cause the appearance of efflorescence.</p> <p>The type of mortar used, the degree of exposure of the masonry to humidity (infiltration, installation of wet bricks, etc.) and the microporosity of the bricks also influence the appearance of efflorescence. It is useful to know that Portland cement-based mortars are more likely to cause efflorescence to appear.</p> <p>However, the risk can be controlled thanks to a well-thought-out choice of materials and architectural details as well as careful installation.</p>



Characteristics	Exposed		Unexposed		Comments
	L.b	N.L.b	L.b	N.L.b	
<b>Water vapour permeability</b>	x	x			This characteristic is to be assessed for exposed and isolated masonry. The resistance coefficients to water vapour diffusion can be taken from tabulated values (EN 1745), depending on the density of the bricks considered or from test measurements.
<b>Content in active soluble salts</b>	x	x			<p>This characteristic can influence efflorescence as well as the resistance of cement-based joints. In general, bricks coming from unprotected masonry have evacuated a large part of the soluble salts that they could have contained. To avoid using bricks with too high a soluble salt content, it is recommended not to re-install bricks that have been in contact with the ground (foundations, cellars), or from stables, old fireplaces, septic tanks, foundations at the edge of the road (snow melt salts), etc.</p> <p>The soluble salt content can be laboratory tested or using indicator strips.</p>
<b>Toxicity</b>	(x)	(x)	x	x	<p>In the outset, clay bricks are not likely to contain dangerous substances. However, during their lifetime, they could have been contaminated in various ways (mould, finishing treatments, painting, absorption of contaminated water, etc.). In the absence of a precise determination method, it is advisable to avoid the reclamation of bricks from cesspools, foundations, oil tanks, stables, etc. (+ see § <i>Hazardous substances and precautions</i>).</p>



Bricklaying of a façade with three different models of reclaimed bricks. Chiro Itterbeek (BE). © ROTOR



**Availability**

Almost all reclaimed bricks sold by specialist suppliers are sorted, inspected, cleaned, palletized and ready for delivery. Several Belgian suppliers have reported an interesting development on the reclaimed brick market. In the past, so-called “hand-made” bricks were the most popular. These are irregular-looking bricks, often one hundred years old or even two hundred years old. Since the 1990s, the frequency of dismantling of very old buildings has declined while the demand for reclaimed bricks has persisted. The consequence of this was to lead salvage operators to take an interest in more recent types of solid bricks, qualified as “mechanical” (extruded) bricks. These date from the first half of the twentieth century and have a more regular appearance. These more recent reclaimed bricks have gradually found a place on the market. Because they are more common in dismantling, they are also less expensive than hand-made reclaimed bricks.

**Indicative prices (Excl. tax, for private customers)**

Random sampling of the reclamation market in Western Europe (Belgium, France, Great Britain and the Netherlands) made it possible to extract some indicative prices. These vary according to the models and their dimensions, the quality of the batches and their rarity.

- and-moulded bricks: from 0.30 to 0.60 €/pc
- extruded bricks: from 0.25 to 0.35 €/pc

**Find specialised businesses**

**SALVO** **OPALIS**

salvoweb.com opalis.eu

salvoweb.com opalis.eu

In the UK:  
[http://www.brickdirectory.co.uk/html/reclaimed\\_and\\_renovation\\_brick.html](http://www.brickdirectory.co.uk/html/reclaimed_and_renovation_brick.html)



Mixture of reclaimed bricks and new bricks. Folklore Museum, Mouscron (BE). © V+ architectes

**Embodied carbon (Cradle to gate - production A1-A3)**

	kg CO <sub>2</sub> eq./m <sup>2</sup>	kg CO <sub>2</sub> eq./kg
CTMNC (FR)- Collective declaration*	41.6	-
TERREAL (FR) - Individual declaration **	72.9	-
INIES database - Generic data ***	23.2	-
ICE Database (UK) – Clay Brick****	-	0.45
GAMLE MURSTEN (DK) - Reclaimed brick	-	0.0027

\* Indicative value for a facing masonry of 1 m<sup>2</sup> in clay bricks (mortar and ties included). Valid for exposed bricks whose mass per m<sup>2</sup> is between 75 kg/m<sup>2</sup> and 186 kg/m<sup>2</sup>.

\*\* Indicative value of 1 m<sup>2</sup> masonry in hand-moulded solid brick (136 kg/m<sup>2</sup>), (mortar and ties included)

\*\*\* Indicative value for a 1 m<sup>2</sup> wall made of small clay masonry products (thickness between 15 and 25 cm)

\*\*\*\* Indicative value for a clay brick (specific weight 2.13 kg/brick)

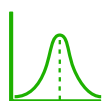

According to the sources, reusing 100 m<sup>2</sup> of reclaimed clay bricks prevents the production of ~ 2 320 to ~ 7 290 kg of CO<sub>2</sub> equivalent related to the manufacture of new bricks (production phase only). This corresponds to a trip of ~ 13 900 to ~ 43 700 km in a small diesel car. Based on the data collected, we can estimate (in a simplistic way) that the impact of the reclamation of bricks on the global warming index is up to 150 times less.





**Hazardous substances and precautions**

*Cement dust* can contain silicon or quartz particles which can be harmful to health. It is recommended to provide the necessary protective equipment when dismantling and cleaning the bricks (FFP3 masks).

*Dry rot*, is a wood-eating fungus that thrives and attacks wood in humid or poorly ventilated conditions, which can cause structural damage. Although it does not attack masonry, the fungus produces spores that can infiltrate bricks and mortars near attacked woodwork. The use of reclaimed bricks can therefore be a source of propagation if the hygrometric conditions are poorly controlled.



Interior wall facing in reclaimed bricks. Zonnige kempen. (BE)



Extension of a single-family house. Reclaimed brick façade cladding. Brussels (BE) © Sophie Boone for VLA-Architecture

LE BATI BRUXELLOIS SOURCE DE NOUVEAUX MATERIAUX

Fiche produit-application : briques de terre cuite destinées à être réemployées en parement  
Mai 2021

Logos: UCLouvain, CSIC, VUB, Région de Bruxelles-Capitale, Région flamande, Région wallonne, Région de Bruxelles-Flandre

**Read more!**

Product sheet-application: clay bricks for re-use in facing. *The Brussels Building: Source of new Materials (BBSM)*. May 2021. (In French).  
<https://www.bbsm.brussels/wp-content/uploads/2021/06/annexe-17-WP6-fiche-produit-application-briques-de-terre-cuite-parement.pdf>

**Read more!**

Diagnostic and performance evaluation methodology for the re-use of bricks - *Fondation Bâtiment Énergie (FBE)*. December 2020 (In French).  
<http://www.batiment-energie.org/doc/70/FBE-ECB-enjeu-A-brique-V5.pdf>

ÉCONOMIE CIRCULAIRE DES BÂTIMENTS

**Méthodologie de diagnostic et d'évaluation des performances pour le réemploi de briques**

FONDATION BÂTIMENT ÉNERGIE

**Disclaimer**

This sheet is intended for designers, specifiers and other members of construction project teams wishing to reuse this building material or product. It is part of a collection of sheets aimed at bringing together the available information to date that is likely to facilitate the reuse of building materials and products.

This sheet has been produced by Rotor vzw/asbl within the framework of the Interreg FCRBE project - Facilitating the Circulation of Reclaimed Building Elements, supported by the entire project partnership. Sources of information include the experience of reclamation dealers and involved project partners, lessons learned from exemplary projects, available technical documentation, etc.

The sheets have been produced between 2019 and 2021. As the reclamation sector is evolving, some information, notably regarding pricing and availability, may change over the time. When the text refers to European standards, it is up to the project team to refer, if necessary, to their national implementations and local specificities.

It is important to note that the information presented here is not exhaustive or intended to replace the expertise of professionals. Specific questions are always project related and should be treated as such.

The complete collection of sheets (including the introductory sheet) is freely available from different reference websites (a.o. [opalis.eu](http://opalis.eu), [nweurope.eu/fcrbe](http://nweurope.eu/fcrbe), [futureuse.co.uk](http://futureuse.co.uk)).

Non-exhaustive directories of dealers in reclaimed building materials are available on [www.opalis.eu](http://www.opalis.eu) and [www.salvoweb.com](http://www.salvoweb.com).

---

Interreg FCRBE partnership: Bellastock (FR), the Belgian Building Research Institute / BBRI (BE), Brussels Environment (BE), the Scientific and Technical Center of Building / CSTB (FR), Confederation of Construction (BE), Rotor (BE), Salvo (UK) and University of Brighton (UK).

The information contained in this document does not necessarily reflect the position of all the FCRBE project partners nor that of the funding authorities.

Unless explicitly stated otherwise, the content of these sheets is credited in the Creative Commons Attribution NonCommercial – Share Alike format (CCBY-NC-SA).



Unless explicitly stated, the images used in this document belong to © Rotor vzw/asbl or © Opalis. Any other image has been the subject of a systematic request for authorisation from their authors or rightful owners. When this request has not been answered, we assumed that there were no objections to the use of the image. If you feel that this interpretation is unreasonable, please let us know.



**Material Description**

Clay roof tiles are obtained by firing moistened, mixed, degassed clays (or loam); shaped by pressing or extrusion, moulded or preformed; dried and finally fired at a temperature of 1000 to 1100 °C for 12 to 48 hours. It is a ceramic material manufactured by hand or industrially, the technical properties of which depend essentially on the composition of the mixture, the firing temperature, the technical skill used in the manufacture and the surface finish. Under normal conditions, they ensure the waterproofing of roof covering or exterior cladding structures. Clay tiles have very good durability (lifespan up to 100 years). However, during their use, they will be subjected to a series of factors likely to affect their integrity and their properties (for example: the slope of the roof and the drainage capacity, the meteorological and climatic factors, the orientation of the slope, the behaviour of the finish layer, the frequency of roof maintenance, etc.)



Produced in abundance in Europe since the 19th century, clay tiles are readily found on the reclamation market. They should not be confused with their concrete counterparts, which are more porous and have an estimated lifespan of 50 years.

→ **Formats:** there is a very wide variety of models and formats, generally associated with a producer and/or a region of origin as well as with the climatic and installation conditions (roof slope, necessary waterproofing, surrounding vegetation, orientation slope, wind resistance, loads on the frame, etc.). A distinction is made between overlapping tiles (flat tiles, barrel tiles, purlin tiles, etc.) and interlocking tiles (single, double or triple; head and/or lateral interlocking). Depending on the type and model, between 10 and 20

tiles/m<sup>2</sup> are required for interlocking models, and up to 65 tiles/m<sup>2</sup> for overlapping models.

→ **Accessories:** several accessory parts, associated with specific models, are found in smaller quantities on the reclamation market. For example: ridge/hip tiles, butt tiles, edge tiles, vented tiles, half tiles, etc.

→ **Finished and Colors:**

- **Untreated:** the tiles have a red colour (uniform tile), determined by the type of clay used and the iron oxide content. Their appearance is mainly matte and slightly rough.
- **Engobed:** After the drying process, a thin layer of clay is applied to the tile to which mineral oxides or pigments have been added. During firing, this layer merges with the underlying tile. The result is a dark red, brown or black tile with a shiny or satin appearance.
- **Glazed:** a glaze suspension is applied to the unfired tile. During firing, this layer vitrifies and makes it possible to obtain red, brown and black, matte or shiny tiles, in different shades. Glazed tiles are generally smooth, have very low porosity and are more resistant to dirt, moss and algae.
- **Dark tile:** Using manganese pigmented clays, the tiles are completely black, throughout their thickness; superficial damage is therefore little or not visible.
- **Braised:** the tiles are fired in a reduction atmosphere, which gives them a blue/grey appearance.
- **Preservation treatments:** some reclaimed tiles may show traces of a water-repellent preservation treatment or of a coat of paint applied during use.







### Material reclamation

The recovery of tiles must always be done in compliance with the safety rules applicable to roofing work. If the tiles do not find a new use directly on site, they can be sent to professional reclaimed channels. There are in fact operators likely to recover batches of tiles. Their interest will depend essentially on the model of tile, the quantities and the general condition of the batch.

→ **Dismantling** test (or expert opinion): in practice it makes it possible to ensure the feasibility and profitability of a removal. An 'expert eye' generally makes it possible to estimate the interest of a batch based on photos or information on the back of the tiles, or by an on-site visit. The focal points will be among others:

- the general condition of the batch and the method of installing the elements (free, nailed, screwed, fixed to the battens by clip hooks, sealed with mortar, etc.);
- commercial interest (depending on the tile model, quantity, resale potential, regional specificities, etc.);
- safety provisions (condition of the frame, roof slope, building configuration, etc.);
- logistics arrangements (deadline, working time, handling, transport, etc.).

→ **Removal**: careful dismantling should aim to ensure the integrity of the tiles and a certain uniformity of the batches. The tiles will be sorted by models, quality, possible deterioration, colours, dimensions, degree of soiling and accessory parts. Tiles showing breaks, cracks, significant damage to the surface layer, crumbling or traces of lead will be downgraded. The tiles recovered will preferably be stored on their edge in order to limit the risks of breakage and prevent the accumulation of water which can aid the development of algae and mould and which can deteriorate the porosity and the technical properties of the tiles.

#### Hearing test!

To check if a tile is intact, you can probe it by tapping lightly with a hard object. A 'dull' sound indicates an internal fracture, a 'clear' sound means that the tile is unaltered.



→ **Treatment**: apart from a qualitative sorting, reclaimed tiles generally do not undergo any treatment. Please note that high pressure cleaning can severely damage the surface layer and affect the impermeability. If necessary, the tiles can be cleaned with a soft brush to remove moss, algae and other dirt.

→ **Storage**: the tiles are ideally stored on box pallets, taking the necessary precautions to limit the risk of breakage (packaging on their edge, separation of layers, etc.) or transported in bulk to the storage place and stacked vertically several rows in height.

→ **Transport and delivery**: the necessary precautions must be taken during transport and delivery in order to minimise breakage (strapped, shrink wrapped pallet, etc.).

It is advisable to involve specialised professionals to ensure the smooth running of these operations.

For batches of old tiles, the percentage of loss at the time of removal can reach 40%. It is therefore often necessary to adapt the project or to supplement with other reclaimed tiles or new tiles in the event of on-site fitting.







### Applications and laying

Reclaimed clay tiles are mainly used as roof coverings or exterior cladding. As a general rule, the choice of tiles must take into account the expected stresses (see § 'Characteristics and fitness for use') and urban planning regulations. In all cases, reference should be made to the European and national standards relating to the product (EN 1304:2013) and to the rules of practice in force (or implementation standards).

The reuse of a complete batch of reclaimed clay tiles in good condition is no different from that of new tiles. They lend themselves to the same variety of installation methods. They raise the same points for consideration, in particular: properties and condition of the frame and sub-roof, climatic and meteorological factors, minimum slope, fastening system, anchoring points and safety hooks, connection works, waterproofing underlay, ventilation system, drainage and rainwater collection, installation costs and times, specific maintenance, etc.

To facilitate installation, the designer/specifier will take care to use batches with a certain degree of uniformity in terms of the following characteristics:

→ **Batch composition:** the batch must consist entirely of the same model of clay tiles. The supplied accessories must be compatible.

→ **Completeness of the batch:** before purchasing a batch or opting for reuse on site, it is necessary to ensure the availability of the necessary accessories (new or reclaimed) and compatibility with the restoration of a roof covering in reclaimed tiles. Depending on the project, these accessories may concern: clip hooks, ridge/hip tiles, half-tiles, edge tiles, vent tiles, end tiles, etc.). Reclaimed tiles generally do not have installation guides, so it is advisable to hire a professional roofer to assist with your project.

→ **Dimensions:** the dimensions of the tiles must be uniform. Variations are however possible for old, handmade tiles. The dimensional tolerance will be determined by the designer/specifier according to the installation constraints.

→ **Colour:** variations in colour and appearance are possible. In the case of reclaimed clay tiles, these variations may be due to the production method, the original exposure, previously applied treatments, etc. It is advisable to mix the tiles when installing.

→ **Condition:** reclaimed tiles may show minor alterations such as:

- traces of surface wear, splits or crazing cracks in the glaze/engobe ;
- slightly chipped or cut edges ;
- slight damage to the protrusions/hooks and the fixing holes ;
- damage to the assembly grooves and/or flow rims ;
- stains, traces of mould, swellings, etc.

These deteriorations can influence the technical and aesthetic performances of the tiles, as well as their reinstatement, but do not constitute a major obstacle for reuse (see § 'Characteristics and fitness for use'). It is up to the designer/specifier to define the degree of imperfection tolerated, according to the defined use and the installation conditions, by specifying the degree of acceptable alterations.

→ **Quantity:** some suppliers may include a 5% surplus when the product is delivered if they are not able to guarantee the absolute uniformity of the characteristics mentioned above. This surplus can also be applied in the case of an on-site salvage scenario.

Most professional suppliers are able to ensure that delivered batches meet these requirements. Most of the reclaimed building materials are sold as is. The conditions of sale may however contain specific guarantees specific to the material. Some suppliers are able to indicate the origin of the material and/or provide documentation on the product purchased (for more information, see introductory sheet).

#### Tip!

*Clay tiles from stables, which are subjected to strong nitrogen and sulphur fumes, tend to crumble easily. Depending on their condition, it is not always advisable to reuse them.*



#### Find specialised businesses

**SALVO**  
salvoweb.com

**OPALIS**

[salvoweb.com](http://salvoweb.com)

[opalis.eu](http://opalis.eu)



**Characteristics and fitness for use**

The harmonised European standard EN 1304:2013 establishes the relevant characteristics (depending on the context) in order to determine the fitness for use of clay tiles. Although detailed for new materials, these characteristics may prove useful in considering the specific case of reclaimed clay tiles.

Characteristics	Comments
<b>Dimensions (length, width), regularity of shape</b>	These characteristics are closely related to the degree of sorting of the reclaimed tiles. A visual or detailed examination of the batch is often sufficient to estimate them. The irregularity of old hand-moulded tiles must be taken into account when refitting them.
<b>Structure</b>	Tiles showing cracks, breaks, crumbling or missing hooks are discarded. A hearing test (see above) can be set up when installing. This characteristic is therefore linked to the degree of sorting of the reclaimed tiles. A visual or detailed examination of the batch is often sufficient to estimate them.
<b>Surface quality</b>	Scratches, scrapes, scuff marks, swelling and crazing cracks in the glaze are not considered to be defects as long as they do not affect the physical and mechanical properties of the tiles.
<b>Impermeability</b>	<p>Ceramic tiles are porous in nature. Glazed, engobed or water-repellent finishes improve water tightness. It is therefore necessary to ensure the surface condition of the tiles and the finish layer. The presence of moss and algae on the tiles may indicate a deterioration of the waterproofing.</p> <p>For overlapping tiles, in the absence of drainage grooves, the water tightness of the system is not guaranteed. This involves providing a good waterproof underlay. This arrangement is also valid for overlapping tiles with signs of deterioration in the assembly grooves and/or flow rims. It is also possible to test the waterproofness of a batch in the laboratory.</p>
<b>Flexural strength</b>	To be taken into consideration according to the climatic zone (strong winds, snowfall, etc.) and the configuration of the roof (orientation, slope, etc.). Specific tests can be performed in the laboratory to determine the breaking strength of a batch.
<b>Frost resistance</b>	Reclaimed tiles have generally passed the test of time and freeze/thaw cycles. However, it is important to compare the origin of the batches and the climatic zone of installation. For old tiles that have been damaged by frost, please refer to the point on structural characteristics. Specific tests can also be performed in the laboratory.
<b>Performance regarding an exterior fire</b>	According to the European Commission decision 2000/553/EC, clay roof tiles belong to the B <sub>ROOF</sub> class (t1) without additional testing, subject to the design and proper realisation of the roof.
<b>Reaction to fire</b>	In accordance with European Commission Decision 96/603/EC, clay roof tiles are classified as non-combustible materials and belong to the European reaction to fire class A1 without prior testing.
<b>Fixings</b>	Several fixing methods are generally accepted. It is advisable to refer to the installation rules and the condition of the fixing device to judge the conformity of the batch (in particular for cladding applications). Some implementation rules may require the presence of 2 fixing holes. It is always possible to (re)drill the tiles, but this work is tedious.
<b>Overlapping</b>	For overlapping tiles (flat tiles, purlin tiles, etc.), a minimum overlap distance and cross-joint installation must be observed. In the absence of specific technical documentation relating to reclaimed products, reference should be made to new equivalents or to the experience of professionals.
<b>Toxicity</b>	The tiles must not be contaminated with lead (visible as grey traces) from external elements. This characteristic is therefore linked to the degree of sorting of the reclaimed tiles. A visual or detailed examination of the batch is often sufficient to estimate them.

in the event of specific and demanding applications, parameters related to characteristics such as mechanical resistance, frost resistance or impermeability can be measured and quantified using tests carried out by accredited laboratories.





**Availability**

Clay roof tiles are present in relatively large quantities on the reclamation market, depending on the model and the geographic region. The most common batches of models easily reach a few hundred to a few thousand m<sup>2</sup>. The rarer models and some decorative items are mainly sold for repairs or roof renovations. Some resellers are also suppliers of new tiles and accessories.

In Belgium, the tiles concerned are mainly Boom tiles, Burgundy tiles, Side tiles, Storm tiles, Flat tiles, etc.

The market is very important in the Netherlands. The most common rustic models are Boom tiles, Side tiles, Storm tiles, Ball tiles and Roman tiles. Contemporary engobed or glazed models are also widely available.

In France, the offer is more focused on French types of rustic tiles and half-round tiles.

**Indicative prices (excl. tax)**

A non-exhaustive sample of the Western European reclaim market (Belgium, France, UK, and the Netherlands) has allowed us to extract some indicative prices:

- Inexpensive and common models: from €8/m<sup>2</sup>
- Contemporary models: €15–25/m<sup>2</sup>
- Rare models: €35–40 €/m<sup>2</sup>
- Accessory parts: €15–25/piece

**Hazardous substances and precautions**

*Lead:* Some old tiles were made from engobe or lead-based glaze. Some tiles may also have been contaminated with lead or other substances from associated roofing elements.



*Read more!*

*Diagnostic and performance evaluation methodology for the re-use of clay roof tiles - Fondation Bâtiment Énergie (FBE). December 2020 (In French).*

<http://www.batiment-energie.org/doc/70/FBE-ECB-enjeu-A-facade-V5.pdf>

**Embodied carbon (Cradle to gate – production A1-A3)**

	kg CO <sub>2</sub> eq./m <sup>2</sup>	kg CO <sub>2</sub> eq./kg
INIES database (FR) – Generic data*	26.4	0.53
CTMNC – Collective Declaration – Interlocking tiles **	12.2	0.27
CTMNC – Collective declaration – Half-round tiles and flat tiles ***	18.9	0.29
ICE Database (UK) – Clay Tile	24.0	0.48

\* Indicative values for a surface mass estimated at 50 kg/m<sup>2</sup>  
 \*\* Indicative values for a surface mass estimated at 45,4 kg/m<sup>2</sup>  
 \*\*\* Indicative values for a surface mass estimated at 65,8 kg/m<sup>2</sup>



According to the sources, reusing 100 m<sup>2</sup> of reclaimed clay tiles prevents the production of ~ 1220 to ~ 2640 kg of CO<sub>2</sub> equivalent related to the manufacture of new tiles (production phase only). This corresponds to a trip of ~ 7 320 to ~ 15 840 km in a small diesel car.



Example of reused clay roof tiles (BE)  
© AGWA



Example of reused clay roof tiles (BE)  
© recupan.be



Example of reused clay roof tiles (BE)  
© deoudedakpan.be

**Disclaimer**

This sheet is intended for designers, specifiers and other members of construction project teams wishing to reuse this building material or product. It is part of a collection of sheets aimed at bringing together the available information to date that is likely to facilitate the reuse of building materials and products.

This sheet has been produced by Rotor vzw/asbl within the framework of the Interreg FCRBE project - Facilitating the Circulation of Reclaimed Building Elements, supported by the entire project partnership. Sources of information include the experience of reclamation dealers and involved project partners, lessons learned from exemplary projects, available technical documentation, etc.

The sheets have been produced between 2019 and 2021. As the reclamation sector is evolving, some information, notably regarding pricing and availability, may change over the time. When the text refers to European standards, it is up to the project team to refer, if necessary, to their national implementations and local specificities.

It is important to note that the information presented here is not exhaustive or intended to replace the expertise of professionals. Specific questions are always project related and should be treated as such.

The complete collection of sheets (including the introductory sheet) is freely available from different reference websites (a.o. [opalis.eu](http://opalis.eu), [nweurope.eu/fcrbe](http://nweurope.eu/fcrbe), [futureuse.co.uk](http://futureuse.co.uk)).

Non-exhaustive directories of dealers in reclaimed building materials are available on [www.opalis.eu](http://www.opalis.eu) and [www.salvoweb.com](http://www.salvoweb.com).

---

Interreg FCRBE partnership: Bellastock (FR), the Belgian Building Research Institute / BBRI (BE), Brussels Environment (BE), the Scientific and Technical Center of Building / CSTB (FR), Confederation of Construction (BE), Rotor (BE), Salvo (UK) and University of Brighton (UK).

The information contained in this document does not necessarily reflect the position of all the FCRBE project partners nor that of the funding authorities.

Unless explicitly stated otherwise, the content of these sheets is credited in the Creative Commons Attribution NonCommercial – Share Alike format (CCBY-NC-SA).



Unless explicitly stated, the images used in this document belong to © Rotor vzw/asbl or © Opalis. Any other image has been the subject of a systematic request for authorisation from their authors or rightful owners. When this request has not been answered, we assumed that there were no objections to the use of the image. If you feel that this interpretation is unreasonable, please let us know.



**Material description**

**Slate is a metamorphic rock from the schist family. It is composed of a structure of horizontal layers and fine, hard grains. The use of this material for construction has been documented since at least the 12th century. Its properties make it a popular material:**

→ *Fissionable*, slate has a good ability to split into thin and clean sheets, which facilitates their shaping into roofing elements (planimetry and thickness precision).

→ *Very slightly porous*, it is resistant to frost and weathering.

→ *“Flexible”*, it can be cut and drilled easily.

Natural slate has several uses in construction. It is most often found on roofs and for exterior cladding - which are the subject of this sheet. It is not uncommon to find it also available in the form of floor tiles, interior wall coverings, steps, etc. (these uses are not discussed here).

The roofing elements in natural slate (called “slates” in the remainder of the document) generally show excellent durability (reference lifespan of 100 years, or even up to 300 years for quality slates). Specialized craftsmen are able to ensure careful disassembly. In practice, the potential for reclamation depends on aspects such as the original quality of the slates (absence of natural defects), the quality of the original installation, good maintenance and resistance to meteorological and climatic factors likely to alter their properties.

Companies specializing in the reclamation and resale of slates are frequently located in regions which have (or had) a great tradition of exploiting this material: Wales, Scotland, Ardennes, Anjou, Corrèze, etc. Specific names characterize certain traditional models (i.e. “1st quarry”, “cartelettes”, “Princesses”, “Duchesses”, “Bangor Blue”, etc.). Models imported more recently from Spain, China, Canada or Brazil can also be found at

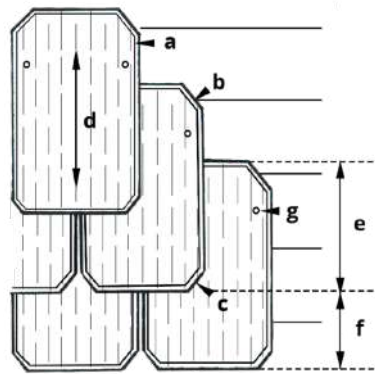

- a. Splinter = sizeable chamfer or bevel, on the visible face
- b. Shoulder = breaking of upper corners
- c. Deflection = breaking of lower corners
- d. Longrain = direction of schist crystals
- e. Cover = part covered with slate
- f. Margin = visible part of an installed slate
- g. Nail hole

Anatomy of a reclaimed natural slate tile. Rectangular model

certain suppliers. In general, the slates produced before the first half of the 20th century are generally thicker and have a rougher aspect than later slates. In any case, they should not be confused with artificial slates (asbestos-cement, fibre-cement, plastics) having a shorter lifespan (30 years) or with other covering stones (i.e. lava or lauzes).

The careful installation or removal of a natural slate roof requires specific know-how. These works are generally entrusted to professional and highly qualified craftsmen (slate roofers).

→ *Formats*. There is a wide variety of models and sizes, usually associated with a manufacturer and/or a region of origin as well as the climatic and installation conditions. Most reclaimed slates are rectangular in shape. Their dimensions generally vary from 120/240 mm to 300/600 mm. There are occasionally square or diamond formats, as well as some particular “tortoiseshell” or “ogive” models. Depending on the model, the thickness generally varies from 2.5 to 9 mm. Reclaimed slate batches may contain models of uniform or variable dimensions (mixed batches).

→ *Colours*. The colour of the slates varies greatly depending on their origin. They are available from light grey to black, passing through shades of orange, dark red, pink, shades of blue, purple and green. Due to the influence of external factors, a reclaimed

slate can show significant differences in colour between the margin (visible part) and the overlap (covered part). These testify to the difference in exposure to climatic elements and bad weather. In general, a uniformity of hue and colour within the same reclaimed slate characterizes a rather recent model, with a low content of carbonates and mineral inclusions.

→ *Appearance and finish*. Depending on their origin and their original production method, reclaimed slates may vary in appearance. For example: smooth or rough texture, presence of old nail holes, presence of traces of mosses and lichens on the exposed parts, variation in the direction of the longrain, etc.



Colour and shade variation between the protected part and the unprotected part © [roofslates.com](http://roofslates.com)

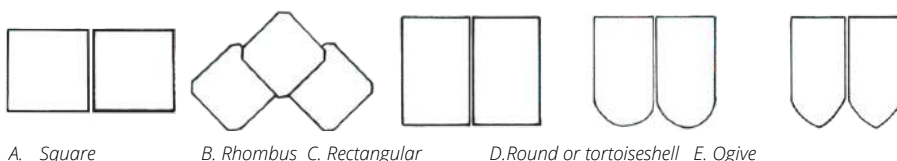

Variations in the shapes of the slates.





**Material reclamation**

**The reclamation of slate must always be done in compliance with the safety rules applicable to roofing work and preferably by a professional. If the slates do not find a new use directly on site, they can be sent to professional reclaimed channels. There are in fact operators likely to recover batches of slates. Their interest will depend essentially on the model, the quantities and the general condition of the batch.**

→ *Dismantling test* (or expert opinion). In practice it makes it possible to ensure the feasibility and profitability of a removal. An “expert eye” makes it possible to estimate the interest of a batch based on photos, during an on-site visit or based on dismantling tests. The focal points will be among others:

- The general condition of the batch:
  - An overall examination of the roof generally provides a first indication of the slate's potential for reclamation (age, general appearance, slope, number of broken slates, percentage of repairs, presence of discolourations or delaminations, etc.). When the slates are placed on battens (installation with hooks) and the roof is not insulated, it is sometimes possible to observe the slates from inside the building. The environment also influences the lifespan and the possibility of reusing slates (i.e. inclination of the roof, atmospheric pollution, presence of trees, insulation and ventilation of the under-roof, etc.). For example, in North-western Europe, roofs facing east and south generally have slates that are less subject to weather factors and are better preserved than those facing west or north. An industrial environment or proximity to the sea are likely to affect the quality of reclaimed slates.
  - An in-depth examination of a slate sample makes it possible to assess their individual condition (*see sorting criteria*) and to extrapolate its characteristics to the entire batch. Checking for flexural strength and water absorption with appropriate testing can also help confirm the batch potential.

*In general, natural slates tend to become more porous under the repeated action of humidity and temperature. They are also sensitive to certain forms of atmospheric pollution (acids). Over the long term, this can result in a gradual increase in their porosity, leading to a decrease in their water tightness. The speed and intensity of this decrease depend on several factors: thickness of the slate, intensity and repetition of external factors but also intrinsic characteristics of the original material. As such, the content of calcium carbonate (calcite) and iron (pyrite), linked to the original deposit of the slates, play a preponderant role in the mechanisms affecting porosity. Under the effect of carbonate, slate may tend to whiten and disintegrate over time (delamination). While pyrite, in its various forms, can cause disorders with various consequences (i.e. streaks of rust, oxidation, perforations). Thin slates with a high calcite and pyrite content therefore tend to degrade more quickly. It should be noted that deterioration affects both exposed and protected faces. Therefore, deteriorated natural slates generally cannot be returned and reused. The initial processing conditions also play an important role in the longevity of slates. Thus, a very sloping roof will tend to limit water retention at the slate level. A well-ventilated loft will also have a beneficial effect on the life of the slates.*

- the installation method of the elements: the reclamation of slates is facilitated in the case of installation with a hook. For a nailed slate roof, it should be ensured that there is no excessive chipping at the level of the existing holes and that the latter are suitable for subsequent installation. If they are too wide, it will be necessary to check the possibility of creating new holes (minimum distance to the edges to be respected ~ 30 mm). Sometimes the slates have already been re-used several times. In the long run, the presence of many holes can complicate their reclamation.
- commercial interest, depending on the slate model, quantity, resale potential, regional specificities, etc.
- safety provisions such as condition of the frame, roof slope, building configuration, etc.
- logistics arrangements: deadline, working time, handling, transport, etc.

→ **Removal.** Careful dismantling should aim to ensure the integrity of the slates and a certain uniformity of the batches. Using a roofer's ladder or scaffolding helps prevent stepping on slates that would not withstand a person's weight. The slates are ideally placed from the top of the roof downwards, using tools appropriate to the method of attachment (pliers, pincers, roofer's hammer, “slate ripper”, etc.). Hooked slates are easily detached after twisting the hook, while nailed slates can be more difficult to remove. For the latter, it is necessary to extract the nail by exerting a lever arm, while avoiding breaking the slate. The type

of nail is also a determining factor (iron nails are more difficult than copper ones). Fasteners are rarely recovered. In some cases it is necessary to sacrifice the first and last row of slates to facilitate removal.

It is advisable to carry out a first sorting during the removal, for example by separating the original slates from those used for “repairs”. In the case of slates laid in rows of variable length (for example laying with decreasing gauge), it is advisable to proceed with the dismantling row by row by grouping the slates of similar length.



« Slate ripper »



Roofer's hammer

*For batches of old and thin slate, the percentage of loss can be very high and reach 80%, or only 20% of the slates recoverable in the end (damaged edges, broken corners + breakage during removal).*



→ **Sorting.** Once lowered, the slates can be sorted directly on site, or shipped in bulk to a professional dealer. The latter will then carry out a visual sorting and a rigorous classification according to the model and the dimensions, the qualitative aspect, the possible deteriorations, the colour, the degree of soiling, etc.

Some of the factors that may lead to the downgrading of natural slates include:

- Major damage: breaks, cracks, chips and punctures (other than old nail holes).
- Deterioration of the surface layer: crumbling, delaminations, protruding nodes.
- Deformations affecting flatness.
- Presence of through mineral or metallic inclusions.
- Presence of efflorescence and suspicious discolourations.
- Presence of numerous nail holes, or holes of unsuitable size;
- Presence of hazardous substances: lead, etc.

→ **Opérations.** Reclaimed natural slates are generally sorted qualitatively (model, dimensions, etc.). If necessary, they can be cleaned with a soft brush to remove moss, algae and other dirt. The use of a high pressure cleaner should be avoided as it could damage the surface layer and affect the waterproofing of slates. Some resellers and roofers also offer to resize and calibrate slates according to the desired model. Repairing nail holes is also possible under certain conditions.

→ **Storage.** Natural slate tiles are ideally stored and stacked in box pallets, taking the necessary precautions to limit the risks of breakage (packaging on the edge, separation of layers, tightening of the elements, etc.) and to avoid water damage.

→ **Transport and delivery.** The necessary precautions must be taken during transport and delivery in order to minimise breakage (strapped, shrink wrapped pallet, etc.).

It is advisable to involve specialised professionals to ensure the smooth running of these operations.

**Hearing test!**

To check if a slate is intact, you can probe it by tapping lightly with a hard object. A “dull” sound indicates an internal fracture, a “clear” sound means that the slate is unaltered.



Breaks, cracks and splinters. © [nachi.org](http://nachi.org)



Mineral inclusions and traces of rust.



“Original” slates and “repair” slates.



Mineral inclusions and traces of rust. © [nachi.org](http://nachi.org)



Efflorescence and delamination. © [nachi.org](http://nachi.org)



Colour variation © [toiture.pro](http://toiture.pro)



Storage of reclaimed slates © [slateprices.co.uk](http://slateprices.co.uk)



Storage of reclaimed slates © [hastingswhite.co.uk](http://hastingswhite.co.uk)





**Applications and installation**

Reclaimed slates are primarily used as roof covering or waterproof exterior cladding, but they can also be used for other less demanding applications such as decorative cladding or interior facing. As a general rule, the choice of slates must take into account the expected stresses (see § Characteristics and fitness for use) and urban planning regulations. In all cases, reference should be made to the European and national standards relating to the product (e.a. EN 12326: Slates and stones for roofing and exterior cladding for discontinuous installation) and in accordance with the rules of practice in force and the applicable installation standards.

The reuse of a complete batch of reclaimed slates in good condition is no different from that of new slates. As long as they are not already perforated, they lend themselves to the same variety of installation methods. They raise the same points for consideration, in particular: properties and condition of the frame and sub-roof, climatic and meteorological factors, overlap, minimum slope, fastening system, air and vapour tightness, roof ventilation system, thermal and acoustic insulation, drainage and rainwater collection, installation costs and times, specific maintenance, etc.

In general, the frame should be sized appropriately, given the potentially heavier weight of a slate roof. A minimum roof slope must be observed.

→ **Fixing.** reclaimed natural slates are fixed with nails or hooks (galvanized, copper or stainless steel). Those with old nail holes are preferably re-nailed and existing holes should be examined to ensure they are in good condition and can be reused. Otherwise, new holes can be made (minimum distance from the edge: 30 mm, minimum distance from old holes: 20-25 mm). Hooking old nailed slates is possible as long as waterproofing can be ensured (depending on the size of the slates, the positioning of the holes, the slope of the roof, the exposure conditions, the overlap, etc.). Installation with nails is carried out on laths and is generally less rapid and more expensive than installation with a hook, which is done on battens. The installation of slate at the level of complex roofing structures (valleys, hip, ridge, chimneys, dormers, etc.) requires excellent know-how.



Hook installation, Caserne de Reuilly, Paris (FR)



Nail installation (source: Pixabay)

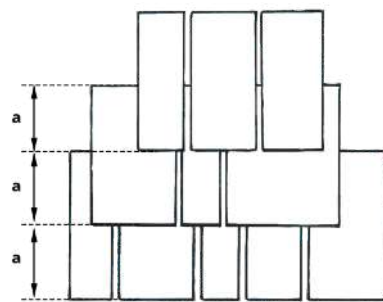

Mixed installation: gauges of equal length, variable width of the slates.

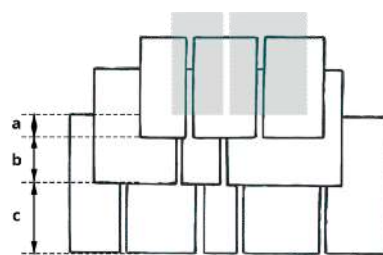

Mixed installation: gauges of decreasing length, variable width of the slates.

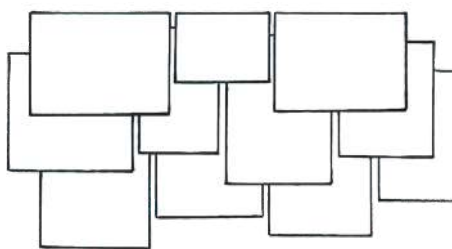

"Staggered butt" installation: use of slates of variable formats and dimensions.

**Tip !**

Reclaimed slates generally do not have technical documentation or specific installation guides. It is therefore advisable to call on a professional roofer/slater to support your project.

→ **Equipment.** Depending on the use (roof or cladding), the shape of the roof, the type of slate, the age of the building or the budget available, there are a large number of types of installation and ways of placing the slates. Some are suitable only for batches that are uniform in size and thickness, while others adapt to greater variability. For example :

- Mixed laying is ideal for laying slates of varying width.
- The traditional laying with decreasing gauge (i.e. the slates are larger at the foot of the slope and smaller and smaller as you go up towards the ridge) allows working with slates of variable width and length (identical length per row).
- In the United States, the so-called "staggered butt" installation allows a mixture of slates of variable width and length or staggered installation on the roof.

To choose a type of installation, it is necessary to define the length of the necessary overlap. This depends in particular on the slope of the roof, the region, the orientation, the drainage length and the fixing method. Overlap tables (see national implementation standards) are used to determine this value. In general, the height of the slates must be at least equal to 3 times the value of the overlap. In some cases, slates can be re-cut, but this involves an additional cost.





To facilitate laying, the specifier will take care to use batches with a certain degree of uniformity in terms of the following characteristics:

→ **Batch composition.** The batch must consist of slates of the same type and same format. In order to ensure relative uniformity of their characteristics, it is preferable to ensure that the slates come from the same original roof.

→ **Completeness of the batch.** Before purchasing a batch or opting for reuse on site, it is necessary to ensure the availability of the necessary accessories (new or reclaimed) and their compatibility when re-using a reclaimed slate roof covering as well as the availability of batches (new or reclaimed) that can complete the area to be covered if necessary.

→ **Dimensional characteristics.** The nominal dimensions and the thickness of the slates must correspond and satisfy the chosen method of installation. The dimensional tolerance will be determined by the specifier according to the installation constraints. It is important to note that most professional suppliers of reclaimed natural slates offer “traditional” models, which have elements of varying sizes.

→ **Colour and appearance.** Variations in colour and appearance are possible within the same slate batch. In the case of reclaimed slates, these variations may be due to the chemical composition, the origin and quality of the batches used, the original exposure, etc. For these reasons, it is advisable to mix the slates when installing.

→ **Condition.** The designer/specifier can specify the condition of the slates tolerated. For example, reclaimed slates may show minor alterations such as:

- superficial chips and signs of wear
- slightly chipped or cut edges
- slight damage to the fixing holes
- stains, traces of mould or lichens, efflorescence
- etc.

These deteriorations can influence the technical and aesthetic performances of the slates, as well as their reinstatement, but do not constitute a major obstacle for reuse (see § *Characteristics and fitness for use*). It is up to the specifier to define the degree of imperfection tolerated, according to the defined use and the installation conditions, by specifying the degree of acceptable alterations.

→ **Quantity.** Some suppliers may include a 5 to 10% surplus during delivery to cover the risks of breakage during transport and handling as well as losses related to the sorting and classification process by the roofer/slater at the time of installation. This amount can vary considerably depending on the type and complexity of the roofing project, and can be particularly high and difficult to predict when using slates of random size. Generally, this surplus prediction can also be applied in the case of an on-site salvage scenario.

Most professional suppliers are able to ensure that delivered batches meet these requirements. Generally, reclaimed building materials are sold as is. The conditions of sale may however contain special guarantees specific to the material. Some suppliers are able to indicate the origin of the material and/or provide documentation on the product purchased (for more information, see the introductory sheet).

**Tip !**

*It is recommended to purchase a sufficient quantity of slates from the outset. Each delivery of reclaimed slates has a unique composition. The slates of a subsequent delivery may therefore have different dimensions and colours.*



*Nailed installation of reclaimed slate, thick model, mixed installation with decreasing gauge (FR)  
© Sarl Ritouet*



*Nailed installation of reclaimed slate, thick model, mixed installation with decreasing gauge (FR)  
© Sarl Ritouet*



*Hook laying of reclaimed slate, fine model (FR)  
© Sarl Ritouet*



*Slates reused as wall covering inside, Hôtel Pasteur (FR) © Encore Heureux architectes*



**Characteristics and fitness for use**

The harmonised European standard EN 12326-1 (product specifications) and -2 (tests) establishes the relevant characteristics (depending on the context) in order to determine the fitness for use of natural slate for roofing and exterior cladding. Although detailed for new materials, these characteristics may prove useful in considering the specific case of reclaimed slate shingles. In general, the expertise of a professional can be useful and necessary to assess the performance of a batch of reclaimed slate shingles.

Characteristics	Comments
<b>Dimensions (length, width), regularity of shape</b>	<p>These characteristics are closely linked to the degree of sorting of the shingles and the method of installation envisaged during re-use. A visual or detailed examination of the batch is often sufficient to evaluate them.</p> <p>For uniform slate batches intended for a fixed geometry installation, it is advisable to pay particular attention to these characteristics. By way of comparison, a tolerance in the order of <math>\pm 5</math> mm over the length and width of the elements is recommended for new slates. It is also advisable to check the flatness and straightness of the elements. However, certain installation methods (see § "Applications and installation") make it possible to work with slates of more heterogeneous dimensions.</p> <p>If necessary, natural slates can optionally be re-cut.</p>
<b>Thickness</b>	<p>In order to facilitate installation, it is recommended to work with batches of reclaimed natural slate of uniform thickness. It is common practice to assess the average thickness of slates based on a sample of 100 slates ("stacked thickness"). In practice, it is recommended that the deviation from the average does not exceed 25%.</p> <p>In general, the minimum individual thickness of new slates is determined from tabulated values depending on the dimensions of the slates, their flexural strength and the climatic and constructional characteristics of the region of application (see Annex B of EN 12326). In addition, adjustment factors should be applied according to carbonate content and sulphur exposure performance.</p> <p>In the case of reclaimed slates, it can be assumed that batches which have experienced their first use without obvious deterioration are correctly dimensioned in thickness. A visual inspection accompanied by simple measurements is then sufficient to evaluate this characteristic. In most cases, it is recommended to work with reclaimed slates with a thickness greater than 3.5 mm.</p> <p>Most of the time, slates are also sorted by thickness by professional roofers at the time of installation. The thicker slates are placed at the bottom of the slope, the medium ones in the middle and the thinner at the top of the slope.</p>
<b>Density</b>	Usually between 2700 and 2900 kg/m <sup>3</sup> (for information only).
<b>Structure</b>	Slates showing cracks, breaks, crumbling are discarded. An audible test can be set up at the time of re-installation (see box "Hearing test!"). This characteristic is therefore linked to the degree of sorting of the reclaimed slates. A visual or detailed examination of the batch is often sufficient to assess it.
<b>Surface quality</b>	<p>A visual examination of the slates ensures this quality. Slates suffering from alterations such as cracks, breaks, coloured inclusions, piercings (other than old nail holes), crumbling, delaminations and protruding knots must be strictly avoided.</p> <p>Scratches, scuffs and other signs of friction are not considered to be defects as long as they do not affect the physical and mechanical properties of the slates.</p>
<b>Water absorption and frost resistance</b>	<p>To ensure their durability, new slates must have a water absorption of less than 0.6% (by mass). For higher values, a freezing test is recommended.</p> <p>Reclaimed slates, for their part, have already undergone cycles of variation in humidity and temperature. Their physicochemical properties and their sensitivity to freezing are likely to have changed over time. While it is relatively easy to see frost damage (delaminations, crumbling, etc.), it is generally more complicated to determine precisely what their precise performance is in terms of water absorption and frost resistance. The absence of notable damage constitutes an indication suggesting a certain quality of the slates, but only further tests will allow this property to be confirmed. The original application of the slates can be another useful clue, especially if they come from an area with a harsh climate.</p>



Characteristics	Comments
<b>Carbonate content</b>	If the carbonate content of slate is too high (> 20%), it is possible that it will start to swell and disintegrate over time. This phenomenon is more frequent for slates of Italian and Portuguese origin and can be aggravated by ambient pollution. Whitish spots are also likely to appear on the surface of slates. This is more of an aesthetic problem since these stains do not affect the durability of the element. Visual examination and sorting of reclaimed slates can generally allow problematic elements to be rejected. A specific laboratory test can also be considered.
<b>Oxidability</b>	Oxidation occurs due to the presence of iron sulphides included in the slates. It is clearly seen through the presence of a rust-orange veil. Reclaimed slates sensitive to oxidation and having been subjected to external factors will generally show traces of rust (up to perforation in certain cases of through pyrite). Depending on the case, this characteristic can affect an entire batch or just part of the elements. A rigorous sorting generally makes it possible to reject problematic elements. Generally, a visual or detailed examination of the batch is often sufficient to evaluate these characteristics.  For more recent slates, sulphur oxide or thermal shock tests make it possible to highlight this risk.
<b>Sulphur dioxide behaviour (SO<sub>2</sub>)</b>	The measurement of the reaction to sulphur dioxide is recommended in highly polluted regions (automobile, industrial or urban pollution). The SO <sub>2</sub> can indeed cause a softening of the slate which will then have to be chosen thicker.  However, depending on their geographical area of origin, reclaimed slates have been able to demonstrate their behaviour to SO <sub>2</sub> during their previous use. A detailed inspection of the batch can then be used to eliminate unsatisfactory slates. If not, a specific laboratory test can be considered.
<b>Thermal shock resistance</b>	The specifier will ensure that the behaviour of the slates to thermal shock is in line with the type of installation and the intended use. In general, depending on their geographical area of origin, reclaimed slates have been able to demonstrate their behaviour to thermal shocks during their previous use. Rigorous sorting and visual examination make it possible to reject slates sensitive to this parameter. A specific laboratory test can also be considered.
<b>Flexural strength</b>	This characteristic should be taken into consideration according to the climatic zone (strong winds, snowfall, etc.) and the configuration of the roof (orientation, slope, etc.).  It varies between 30 and 70 N/mm <sup>2</sup> . The performance level makes it possible to determine the minimum thickness of the slates, depending on the length of the elements (tabulated values, <i>see above "thickness"</i> ).  In general, it can be assumed that reclaimed slates, having experienced their first use without obvious deterioration, are correctly sized with regard to their flexural strength performance. A visual examination accompanied by simple measurements is then sufficient to evaluate this characteristic.
<b>Performance regarding an exterior fire</b>	According to the European Commission decision 2001/671/EC, slate shingles belong to the BROOF class (t1) without additional testing, subject to the design and proper realisation of the roof.
<b>Reaction to fire</b>	In accordance with European Commission Decision 96/603/EC, slate shingles are classified as non-combustible materials and belong to the European reaction to fire class A1 without prior testing.
<b>Toxicity</b>	The slates must not be contaminated with asbestos or lead (visible as grey traces) from external elements. This characteristic is therefore linked to the degree of sorting of the reclaimed slates. A visual or detailed examination of the batch by a professional is often sufficient to assess it.

However, in the event of specific and demanding applications, parameters related to characteristics such as mechanical resistance, frost resistance or impermeability can be measured and quantified using tests carried out by accredited laboratories.



Storage of reclaimed slates



Storage of reclaimed slates © [slateprices.co.uk](http://slateprices.co.uk)



Storage of reclaimed slates © [slateprices.co.uk](http://slateprices.co.uk)





**Availability**

Slate shingles are present in relatively large quantities on the reclamation market, depending on the model and the geographic region. The most common batches of models easily reach a few hundred m<sup>2</sup>. The market is most developed in the United Kingdom. Some professional suppliers offer batches of more than 15,000 pieces.

The rarer models and some decorative items are mainly sold for repairs or roof renovations. Some resellers are also suppliers of new slates and accessories.

**Indicative prices (Excl. tax)**

Random sampling of the reclamation market in Western Europe (Belgium, France, Great Britain and the Netherlands) made it possible to extract some indicative prices. These vary according to the models and their dimensions, the quality of the batches, their rarity and the suppliers. Reclaimed slates can be sold per unit, per square metre or per ton.

- Common models for waterproof covering: 0.5 to 2 € per slate; 30 to 50 €/m<sup>2</sup>
- Rare models: up to € 4.5 per slate; 50 - 150 €/m<sup>2</sup>

Larger models are more expensive, but their installation is faster.

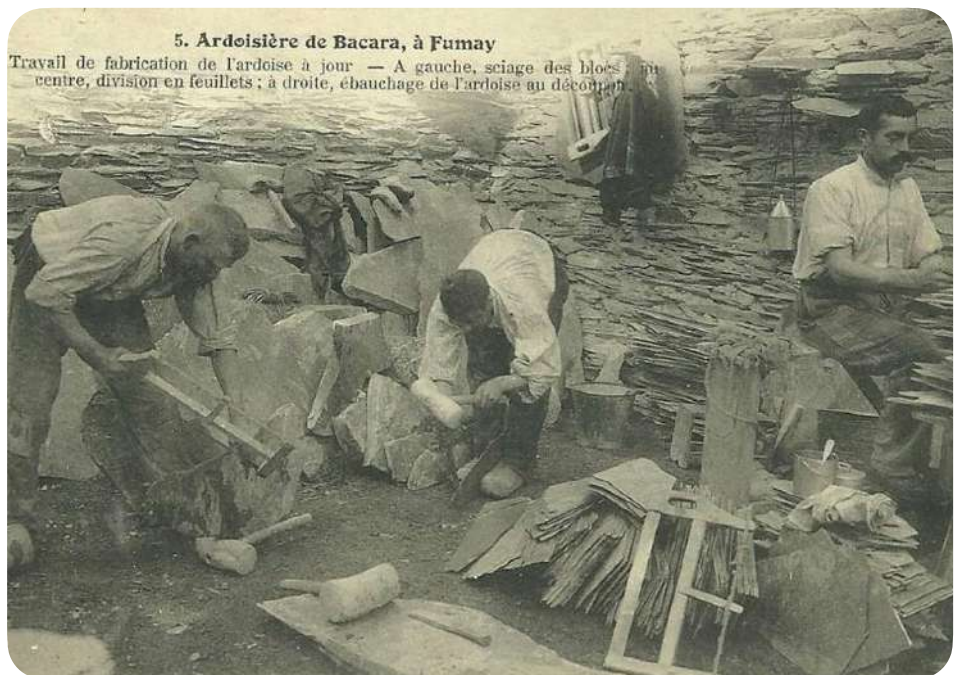
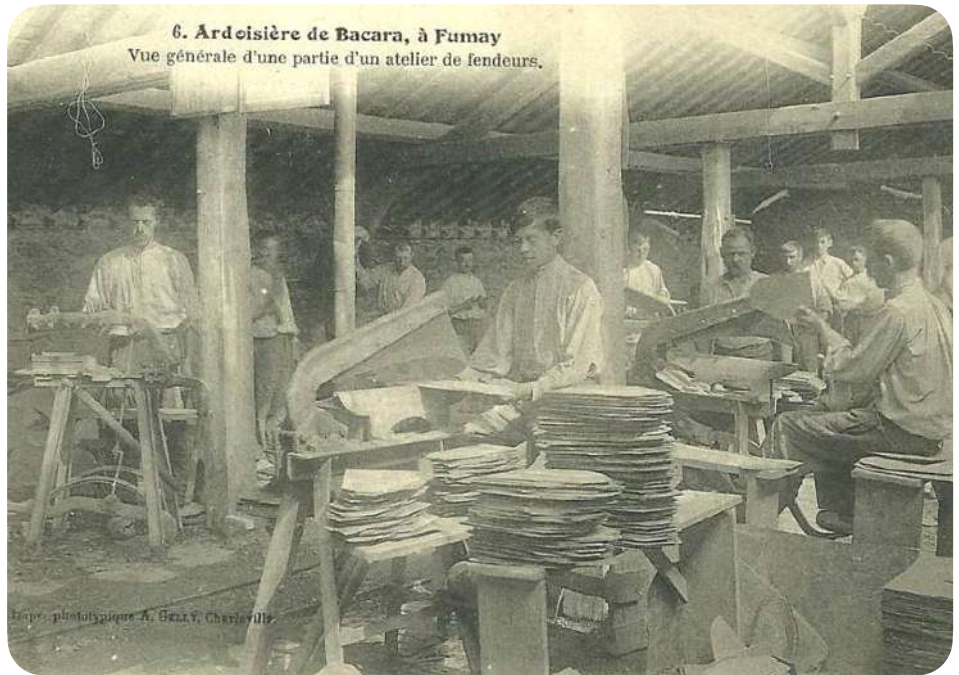

Workshop for manufacturing natural slate roofing elements in the early 20th century, Ardoisières Baccarat, Fumay (FR).

**Find specialist providers**



**Embodied carbon (Cradle to gate - production A1-A3)**

	kg CO <sub>2</sub> eq./m <sup>2</sup>
INIES database (FR) – Generic data *	9.82
CTMNC – Collective Declaration **	3.59

\* Indicative value to ensure the slate roofing of 1 m<sup>2</sup> of roof to a thickness of 4 mm while ensuring waterproofing for a reference life of 100 years.

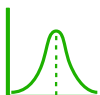

\*\* Indicative value to cover 1m<sup>2</sup> of roofing with CUPA Natural Slates of 4.5 mm thickness and dimensions 32x22 cm (used as roofing), installed outdoors on the roof, for a period of 100 years.



According to the sources, reusing 100 m<sup>2</sup> of reclaimed natural slate shingles prevents the production of ~ 359 to ~ 982 kg of CO<sub>2</sub> equivalent related to the quarrying and production of new slates (production phase only). By way of comparison, this gas quantity corresponds to the emissions caused by a small diesel car during a trip of ~ 2,150 to ~ 5,900 km.



**Hazardous substances and precautions**

	<p>Some slates may also have been contaminated with <i>lead</i> or other substances from associated roofing elements. Vigilance is necessary in case of interior application or likely to come into contact with people. In case of doubt, this diagnosis can be carried out either using a commercially available lead test kit, or by sending a sample to the laboratory or by having this test carried out by a professional.</p>
	<p>From the second half of the 20th century, large quantities of artificial slates were made from <i>asbestos</i> fibre cement. It is not uncommon to encounter this type of slate when repairing natural slate roofing. In case of doubt, it is recommended to discard questionable slates and treat them as hazardous waste. Generally, artificial slates are easily recognizable to the naked eye (no splintering and smooth edged, regular appearance, visible fibres, presence of lettering, etc.). Laboratory diagnosis is also possible.</p>



Reclaimed slate roof and cladding, Ty Pren project (UK), Feilden Fowles architects © David Grandorge



Reclaimed slate © thereclaimedcompany.co.uk



Slate reused and re-installed on the roof © thereclaimedcompany.co.uk



**Disclaimer**

This sheet is intended for designers, specifiers and other members of construction project teams wishing to reuse this building material or product. It is part of a collection of sheets aimed at bringing together the available information to date that is likely to facilitate the reuse of building materials and products.

This sheet has been produced by Rotor vzw/asbl within the framework of the Interreg FCRBE project - Facilitating the Circulation of Reclaimed Building Elements, supported by the entire project partnership. Sources of information include the experience of reclamation dealers and involved project partners, lessons learned from exemplary projects, available technical documentation, etc.

The sheets have been produced between 2019 and 2021. As the reclamation sector is evolving, some information, notably regarding pricing and availability, may change over the time. When the text refers to European standards, it is up to the project team to refer, if necessary, to their national implementations and local specificities.

It is important to note that the information presented here is not exhaustive or intended to replace the expertise of professionals. Specific questions are always project related and should be treated as such.

The complete collection of sheets (including the introductory sheet) is freely available from different reference websites (a.o. [opalis.eu](http://opalis.eu), [nweurope.eu/fcrbe](http://nweurope.eu/fcrbe), [futureuse.co.uk](http://futureuse.co.uk)).

Non-exhaustive directories of dealers in reclaimed building materials are available on [www.opalis.eu](http://www.opalis.eu) and [www.salvoweb.com](http://www.salvoweb.com).

---

Interreg FCRBE partnership: Bellastock (FR), the Belgian Building Research Institute / BBRI (BE), Brussels Environment (BE), the Scientific and Technical Center of Building / CSTB (FR), Confederation of Construction (BE), Rotor (BE), Salvo (UK) and University of Brighton (UK).

The information contained in this document does not necessarily reflect the position of all the FCRBE project partners nor that of the funding authorities.

Unless explicitly stated otherwise, the content of these sheets is credited in the Creative Commons Attribution NonCommercial – Share Alike format (CCBY-NC-SA).



Unless explicitly stated, the images used in this document belong to © Rotor vzw/asbl or © Opalis. Any other image has been the subject of a systematic request for authorisation from their authors or rightful owners. When this request has not been answered, we assumed that there were no objections to the use of the image. If you feel that this interpretation is unreasonable, please let us know.



**Material description**

**By definition, natural stone sills (or thresholds) are construction elements that form the lower part of the openings in order to facilitate the flow of water, prevent infiltration and limit the clogging of masonry.**

Like other natural stone materials, stone sills are good candidates for reclamation and reuse: they are resistant, have beautiful finishes and lend themselves well to various transformations. They are commonly found on the reclamation market, in a multitude of variants often reflecting regional specificities (blue stone in Belgium, Burgundy stone in central France, various kinds of sandstone in the United Kingdom, etc.).

This sheet focuses on the use of natural stone as door thresholds or windowsills. In practice, windowsills are reclaimed more often than door thresholds. The latter are sometimes more complicated to disassemble and may show more marked signs of wear.

The shape of the sills is the result of a set of constraints:

- **To ensure watertightness and allow water to flow.** The protrusion from the façade, the presence of a drip groove, the drop from the upper surface or the presence of a rise (horn, flashing), possibly extended laterally (stool) are some of many devices to prevent infiltration (Figure 1).

- **To ensure the solidity of the structure.** The sills are generally placed on a bed of mortar. To prevent them from tipping over, they are embedded laterally in the masonry to a depth of at least 5 cm.

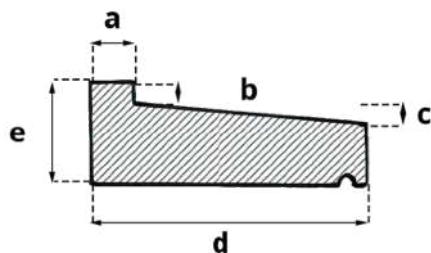

Figure 2. Cross-section of a window sill in natural stone

- a. Horn width
- b. Horn height
- c. Bevel height
- d. Sill width
- e. Sill thickness

The reclamation market has a wide variety of sills models. Several criteria make it possible to distinguish them:

→ **Geological nature.** Many types of rocks were used in the manufacture of sills. Among the most common on the reclamation market, we find granites, sandstones and limestone (blue stone or white stone), in all their local variations.

→ **Dimensions.** Usually the reclaimed sills have widths between 20 and 40 cm, thicknesses between 4 and 20 cm and variable lengths. Unlike current new sills, which are often divided into two parts when over 155 cm in length, there are reclaimed sills of up to 2 m (Figure 2).



Blue stone door threshold (limestone)



Blue stone windowsill (limestone)

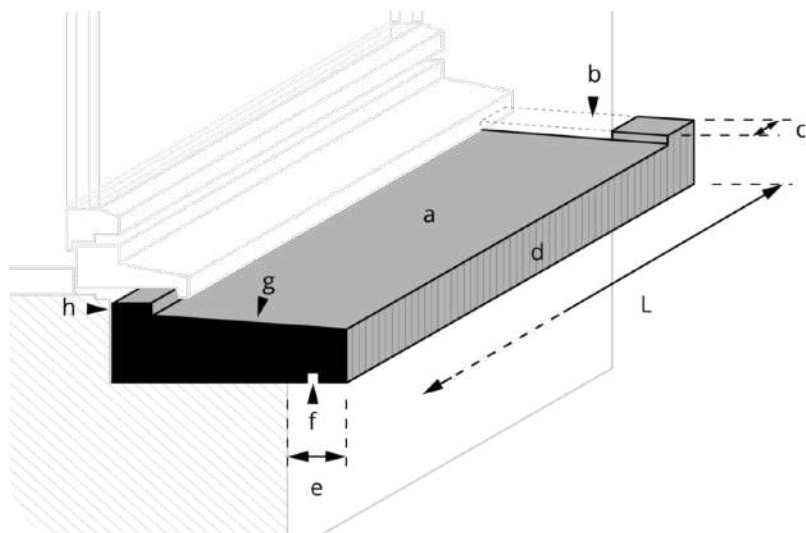

- a. Upper face (ground, bush hammered, softened, etc.)
- b. Stool (glued)
- c. Embedding depth
- d. Front face (chiselled, ground, ...)
- e. Overhang of the façade plane
- f. Drip groove or anti-drip device
- g. Drain slope
- h. Horn or window flashing

Figure 1. Geometry of a window sill in natural stone.



## Natural stone sill

→ **Profiles.** Different sills profiles can meet (see figure 3). Sills that are not at the same level as the ground generally have a drop to facilitate drainage. To do this, they can have a sloping profile (figures 3b, 3d and 3e) or be placed at an incline (figures 3a, 3c and 3f).

→ **Appearance.** The diversity of rocks is reflected in a wide range of colours, including within the same family: grey, beige, ochre, brown, pink, bronze, etc. A specific vocabulary is used to designate the stone inlays: veins, grains, strata, flames, stains, etc.

In addition to the original appearance of the rock, the sills can bear the marks of their cutting method (cleavage, sawing) and of their original finish (grinding, sanding, softening, chiselling, bush hammering, flaming, etc.). Over time, their appearance also varies according to the stresses of use: softening, polishing of the visible face, traces of paint, mortar, development of organisms (mosses, lichens), etc.

When a re-machining of the reclaimed sills is envisaged (sawing, squaring, milling, etc.), this will generally modify the appearance of the visible faces.

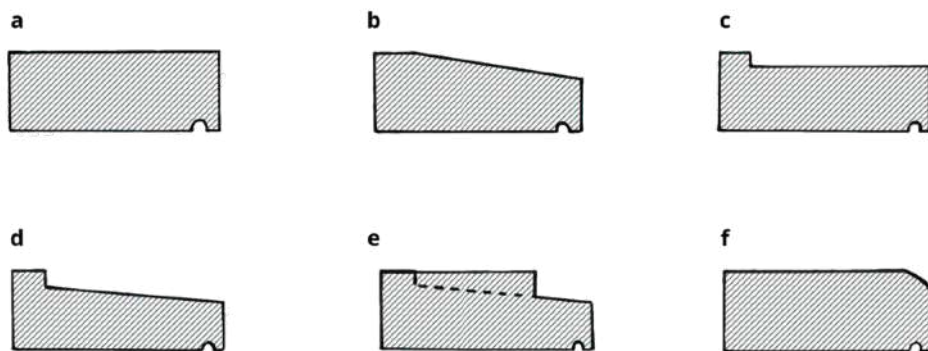

Figure 3 : a. Classic flat sill with drip groove (inclined installation)  
b. Sill with continuous slope and drip moulding and flat at the rear of the sill  
c. Sill cut flat with drip groove and horn (inclined installation)  
d. Bevelled threshold with drip groove and horn  
e. Bevelled sill with drip groove and horn and side seating  
f. Flat threshold with bullnose (inclined installation)



Granite window sill  
© Stone of New England



Sandstone window sill  
© Cawarden Reclaim



Flat threshold in blue stone  
© Het arduinen hoekje



Remains of white painting  
© valleyreclamation.co.uk



Development of living organisms (mosses, lichens)  
© valleyreclamation.co.uk



Traces of remaining mortar  
© valleyreclamation.co.uk



**Material reclamation**

**Natural stone sills are a good candidate for reuse, either on-site or through the professional channels of material resellers. They can also ensure the supply of batches of sills ready for installation. They are able to ensure the smooth running of the following operations:**

→ **Disassembly test** (or expert opinion). Makes it possible to ensure the feasibility and profitability of a removal. An “expert eye” generally makes it possible to estimate the interest of a batch based on plans, photos, historical documents or by an on-site visit. The focal points for sills will be among others:

- the general condition of the batch and the laying method: condition of the stone, formats and dimensions, nature of the laying bed, characteristics of the joints, etc.
- commercial interest, depending on the period, style, stone, condition, quantity in place, etc.
- logistics arrangements: especially in terms of deadline, working time, handling, transport, etc.

In order to more confidently determine the salvage potential of sills, a dismantling and cleaning test is usually performed on a sample.

→ **Removal**. The careful dismantling of sills must ensure the safety of the workers and the integrity of the recovered elements. Once the frame or door has been removed, the sills are first detached from the masonry using suitable tools (jackhammer, pneumatic chisel, etc.) before being pushed out of their notch. The sills can be heavy due to their size and the density of the stone (> 2.5 t/m<sup>3</sup>). They can also be fragile, especially if there are white grooves or veins on the surface of the stone. In the event of cracking or breakage, they lose a lot of their value. It is therefore advisable to equip oneself with suitable means or to call in a professional. Removal may also involve making the necessary arrangements for working at height.

→ **Sorting and cleaning**. The salvaged sills will then be sorted by qualities, colours and dimensions. Cleaning with a brush and water allows removal of laying residues, jointing products and other elements which could adhere to them. Scraping with a suitable blade removes mortar residues and sealant joints. There are products to repair small

cracks and breaks (e.g. mineral mortar, stone grafts, etc.). These can be considered to restore damaged sills.

→ **Operations**. Some sills can be reused as they are after a rough cleaning. Others may require additional operations such as:

- **Sawing**: to obtain flat and vertical side faces or to make the dimensions of the sills uniform.
- **Cutting and machining**: to regain and correct the profile of the sills and ridges.
- **Finish**: in order to homogenize the appearance of the stone or give it a rough appearance on the visible parts. Several techniques are possible depending on the nature of the stone and the expected performance: grinding, sanding, softening, chiselling, bush hammering, flaming etc. A specific vocabulary determines the type of finish depending on the type of rock.

These various operations can be carried out by specialized resellers within their facilities. They can also be considered on site, provided that the site logistics allow it.

→ **Storage and packaging**. Sills are generally stored outside, packaged and strapped on pallets. They are arranged horizontally. Ideally, they are separated by wedging elements in order to limit the risk of damage. The wedges/separation wood must not be treated, be very dry and not contain tannins which could stain the stones. Metal straps should be avoided as there is a risk of staining the stone (rust). The packaging must take into account the large mass of the elements. Appropriate means of transport and lifting are also required.

Reclaimed natural stone sills are generally sold by batch or by piece. Most suppliers are able to provide indications on their main characteristics: type of rock, nominal dimensions and tolerances, finish, intended applications, in certain cases, their origin.



Detachment of the top, side and bottom of the sills  
© CDR Construction



Stacked pallet storage  
© valleyreclamation.co.uk



Storage on strapped pallet





## Applications and installation

**Reclaimed sills can be reused in their original function or be reused for other applications such as exterior flooring, stair treads, street or exterior furniture, etc.**

Most of the considerations related to the implementation of reclaimed stone sills in an identical use are similar to those of new sills - in particular, and non-exhaustively: nature and dimensions of the sills, nature of the bedding, type of jointing, sill profile and difference in level, dimension of the horn, presence of drip groove, construction details, thermal insulation, etc.

It is up to the designers to rely on the regulations in force, the rules of practice and the national and European standards relating to natural stone products. Furthermore, adequate installation requirements must be specified to cover the wide variety of possible applications of reclaimed sills.

In general, finding a batch with very specific characteristics can be complicated. It is often preferable to identify a batch of raw reclaimed sills and to consider additional processing operations. The expertise of professionals can be invaluable in this regard.

The following characteristics can be described and specified when drafting the technical requirements related to the delivery of a batch of reclaimed sills:

→ **Batch composition.** The batch consists of reclaimed stone sills of the same type (same profile), same geological nature (sandstone, granite, limestone, blue stone, white limestone) or even from the same origin of use (geographical area regularly subject to frost, etc.). However, the project developer can choose to combine different batches of stone (formats, type of stone, origins of use, etc.) and distribute them in an organized way in the building (for example, by providing a homogeneous batch of sills per façade).

→ **Dimensions.** The identified batch must correspond to the project constraints. In general, the dimensions must be uniform in width and thickness. To limit costs and facilitate the identification of a batch, it is preferable to be flexible enough on the dimensions by defining only the intervals of width, length and thickness that satisfy the project constraints (width allowing an overhang, interval of thickness, etc.). It is also possible to consti-

tute a long sill from similar elements of a smaller size. If necessary, it is also possible to insist on more precise dimensional characteristics (as well as tighter dimensional tolerances). This may result in a heavier transformation of the material (sawing, re-machining).

→ **Profile.** Ditto. If necessary, specify the expected profile (see figure 3), the shape of the edges (straight sawn, chamfered, rounded, etc.), the degree of inclination and the dimensions of the drip groove. These characteristics may be given approximately (for example, horn height > 10 mm, height difference > 5%, etc.) or defined more precisely.

→ **Texture and finish.** Depending on the requirements (functional and aesthetic) and the type of rock, it may be useful to specify the appearance of the upper faces (sawn, ground, honed, bush hammered, flamed, etc.) and of the seen faces (sanded, honed, ground, chiselled).

→ **Hue.** By nature, natural stones have a wide variety of colours and appearances. Depending on usage requirements (for example, in the context of heritage renovation), it is possible to specify this characteristic by referring to a general hue or to a specific colour.

→ **Condition.** In addition to traces of mortar, paint and bitumen residues, reclaimed sills may show minor alterations such as signs of surface wear, chips, light cracks, craters, light flaking, stains, leftover moss, etc. These deteriorations can influence the technical and aesthetic performance of the sills, as well as their re-installation, but do not constitute a major obstacle to reclamation (see § "Characteristics and fitness for use"). Depending on the nature of the rock, other aspects can be considered as major imperfections. For example, certain limestone rocks (i.e. blue stone) may have stylolithic joints liable to weaken the stone. To a large extent, the existing technical documentation makes it possible to assess these various aspects on a case-by-case basis. Professionals can also be consulted. It is up to the designer/specifier to define the degree of imperfection tolerated, according to the defined use and the installation conditions, by specifying the degree of acceptable alterations (for example: chips, cracks and flaking < x cm<sup>2</sup> tolerated on visible sides, broken corners and edges tolerated on invisible parts, etc.).



*Stylolithic joints*

Most of the reclaimed building materials are sold as is. The conditions of sale may however contain special guarantees specific to the material. Some suppliers are able to indicate the origin of the material and/or provide documentation on the product purchased (for more information, see the *Introductory sheet*).

### *Did you know?*

*Some providers of reclaimed stone items also offer new product lines, some of which are artificially aged to give them the appearance of a used product. If in doubt, find out where the materials are coming from, in order to be sure of their reused origin.*

### *Design tip!*

*In the event of reuse on site, the following points should be checked:*

- *some sills will probably be broken during dismantling. Sills on the reclamation market may possibly supplement the batch on site.*
- *during a renovation, in the event of insulation of the outside, the existing sills may no longer be wide enough and therefore not be able to be reused in the same place.*



## Characteristics and fitness for use

By knowing the family or the type of stone present, it is generally possible to find its general characteristics (depending on the context). These indications are invaluable for studying the compatibility of the reclaimed stone for the intended use.

See for example: [www.febenat.be](http://www.febenat.be) ; [www.stonenaturelle.fr](http://www.stonenaturelle.fr) ; [www.pierreetisol.com](http://www.pierreetisol.com) ; [www.cstc.be](http://www.cstc.be) ; etc.

As an indication, the following table (*Table 1*) shows some of the known performances of some types of rock constituting sills which are frequently reclaimed. It is important to point out that each stone has its own characteristics and that two batches of sills of the same rock can however have quite different performances.

There is no harmonized standard specific to stone sills, but several standards and test methods make it possible to determine the properties relating to natural stones (EN 12407 - Petrographic examination, EN 1936 - Determination of real density and apparent density, and of total and open porosity, EN 12371 - Determination of frost resistance, etc.). Although they relate to new materials, these documents can be useful in determining the relevant characteristics (depending on the project) related to the reclamation of natural stone sills (*Table 2*).

*Table 1 : Technical characteristics of the most common stones used in the manufacture of stone sills*

	<b>Bulk density (kg/m<sup>3</sup>)</b>	<b>Porosity</b>	<b>Wear resistance</b>
<b>Sandstone</b>	2000 - 2700	little porous (0.5 to 10%)	good to very good
<b>Soft limestone (e.g.white stone)</b>	< 2500	porous (5 to 50%)	good
<b>Compact limestone (e.g. belgian blue stone)</b>	> 2500	little porous (0.2 to 5%)	good
<b>Granite</b>	2500 - 3000	very little porous (0.2 to 2%)	very good

*Table 2 : Characteristics to be evaluated in order to determine the fitness for use of reclaimed natural stone sills*

<b>Characteristics</b>	<b>Comments</b>
<b>Geological origin and petrographic description</b>	The reclaimed sills come from works that may have been made from batches of multiple origins. If it is possible to visually characterize the type of rock present, it is however more difficult to affirm with certainty that their geological origin is identical, unless there are records that allow it to be attested (for example: a certificate of origin, archival documents, etc.). This is all the more true for the batches made up of sills of various origins.
<b>Geographical origin</b>	As with the geological provenance, information on the original geographic provenance of a batch of reclaimed sills is difficult to certify with any certainty. On the other hand, we can deduce certain characteristics if we know where the sills were removed. For example, intact and dismantled sills in an area subject to strong freeze/thaw cycles are likely to show good frost resistance. Thus, in the absence of information on the original quarry, it may be useful to have information on the original use or the area where the sills come from.
<b>Geometric characteristics</b>	These characteristics can be found out by taking simple measurements. They are closely linked to the degree of sorting and cleaning of the reclaimed sills as well as to the transformation operations undertaken on the material. In the case of sills intended to be re-machined or re-cut, it is advisable to define with the supplier the dimensional tolerances applicable to each of the dimensions (width, thickness, length, etc.) the type of stone and the functionality of the works. The requirements in terms of flatness, straightness, dimensions of the drip groove and the desired degree of slope should also be detailed.
<b>Bulk density and open porosity</b>	<p>These characteristics are specific to each stone. The density [kg/m<sup>3</sup>] gives an indication of the degree of compactness of the stone. In general, the more compact a rock, the less porous it is.</p> <p>The open porosity of a stone [% by volume] corresponds to the proportion of pores connected to each other and accessible to water. This characteristic influences in particular the degree of resistance to stains and soiling. It does not directly affect its freezing (it is rather its capacity to return the absorbed water that matters at this level).</p> <p>This information can be estimated based on technical documentation relating to natural stones (<i>see Table 1</i>). If necessary, these characteristics can be measured more precisely by an identity test as defined by the test EN 1936.</p>



Characteristics	Comments
<b>Resistance to freezing/thawing (and de-icing salts)</b>	For an exterior application, the natural stone elements must be able to withstand freezing/thawing without their appearance or their mechanical characteristics being affected. The source and condition of a batch of reclaimed sills can provide a useful guide to determining their resistance to freezing/thawing. Many old sills are in fact likely to have withstood, during their first use, more freeze/thaw cycles than what is recommended by the test standard which allows this performance to be assessed (EN 12371). It is therefore important to find out about the geographical origin of the batch to ensure the original climatic conditions (for example, a batch coming from a continental climate in northern Europe will probably be suitable for an application in the Mediterranean climate of the South of France). Generally, less resistant sills that have suffered frost damage will probably have been discarded during the sorting and cleaning steps.
<b>Reaction to fire</b>	In accordance with Commission Decision 96/603/EC, natural stones are considered to belong to class A1 of reaction to fire (see EN 12 058 for exceptions). However, be careful with the use of filler sealants, which can affect this performance.
<b>Susceptibility to staining</b>	<p>To assess this characteristic, we differentiate between internal staining caused by the reaction of certain constituents of the stone (metallic minerals or organic materials present in the stone), from accidental staining caused by contact with a potentially staining product for stone.</p> <p>Internal staining is above all a concern for the aesthetics of the material and it is therefore appropriate for the designer/specifier to define the acceptable characteristics with regard to the intended use.</p> <p>The sensitivity to staining is also directly related to the porosity value of the stone. The higher the porosity, the more easily the stone absorbs liquids (and therefore pollution) and the more sensitive it is to staining. A porosity of less than 4% is generally satisfactory in order to limit the risks of soiling. It is also possible to visually identify the degree of soiling of the reclaimed sills by observing the visible face of the unprocessed (sawn) elements. Specific surface treatments can also be recommended to improve this performance.</p>



*Reuse Inspiration. Sliding sash sill consisting of two old window sills cut to the right size and cut to provide ventilation of the cellar (hole in the centre) © Sophie Boone*





## Natural stone sill

### Availability

Professional suppliers of reclaimed stone materials usually have stone sills. The quantities found are often relatively small (<10 elements) and are therefore mainly suitable for small projects. For larger quantities, it will be necessary to check the stocks with the suppliers sufficiently in advance. Being generally well equipped to work with stone, they can also offer to make stone sills based on other reclaimed elements (wall cover, lintel, step, etc.). Certain elements and certain stones are highly sought after and thus circulate beyond their area of origin. For example, Belgian blue stone is very popular in the Netherlands and Burgundy stone is also found on the Belgian and English markets.

### Indicative prices (Excl. tax)

A non-exhaustive sampling of the reclamation market in North West Europe (Belgium, France, Great Britain and the Netherlands) made it possible to extract some indicative prices. These vary depending on the availability of the size and type of stone, as well as the degree of sorting and cleaning requested.

- Sills of conventional dimensions (between 1m and 1.5m): ~ 40 - 70 €/linear meter
- Long sills: (>1.5m) : ~ 75 - 120 €/linear meter
- Cutting: ~ 40 €/h for cutting the stone

### Find specialised businesses



[salvoweb.com](http://salvoweb.com)

[opalis.eu](http://opalis.eu)

### Embodied carbon (Cradle to gate - production A1-A3)

	kg CO <sub>2</sub> eq./linear meter
INIES database (FR) – Generic data- Natural stone sills *	51.7

\* Indicative value to ensure the function of 1 linear metre of natural stone sill for a reference lifespan of 100 years.

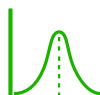

According to the sources and types of stone, reusing 10 linear metres of reclaimed natural sill prevents the production of ~ 517 kg of CO<sub>2</sub> equivalent related to the manufacture of new sills (production phase only). This corresponds to a journey of ~ 3100 km in a small diesel car.

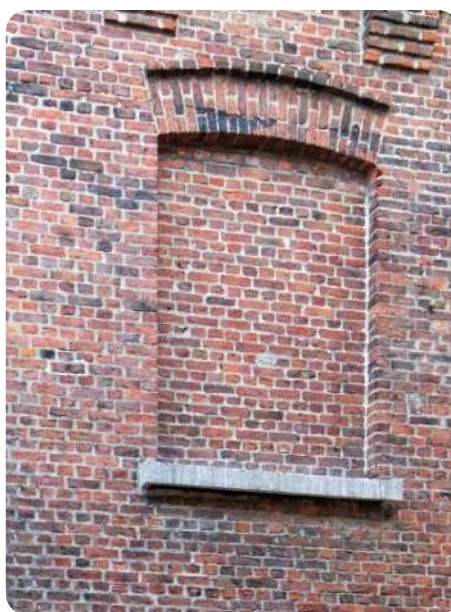

On-site reuse of bluestone sills, reconversion of the former Belle-Vue breweries, Brussels, (BE)  
© François Lichtlé, L'Escaut Architectures. <https://opalis.eu/fr/projets/reconversion-des-anciennes-brasseries-belle-vue>



Illustrated manual for dismantling window frames and sills for reclamation: <https://reuse.brussels/pdf/chassis-et-seuils-de-fenetre/pdf>

**Disclaimer**

This sheet is intended for designers, specifiers and other members of construction project teams wishing to reuse this building material or product. It is part of a collection of sheets aimed at bringing together the available information to date that is likely to facilitate the reuse of building materials and products.

This sheet has been produced by Rotor vzw/asbl within the framework of the Interreg FCRBE project - Facilitating the Circulation of Reclaimed Building Elements, supported by the entire project partnership. Sources of information include the experience of reclamation dealers and involved project partners, lessons learned from exemplary projects, available technical documentation, etc.

The sheets have been produced between 2019 and 2021. As the reclamation sector is evolving, some information, notably regarding pricing and availability, may change over the time. When the text refers to European standards, it is up to the project team to refer, if necessary, to their national implementations and local specificities.

It is important to note that the information presented here is not exhaustive or intended to replace the expertise of professionals. Specific questions are always project related and should be treated as such.

The complete collection of sheets (including the introductory sheet) is freely available from different reference websites (a.o. [opalis.eu](http://opalis.eu), [nweurope.eu/fcrbe](http://nweurope.eu/fcrbe), [futureuse.co.uk](http://futureuse.co.uk)).

Non-exhaustive directories of dealers in reclaimed building materials are available on [www.opalis.eu](http://www.opalis.eu) and [www.salvoweb.com](http://www.salvoweb.com).

---

Interreg FCRBE partnership: Bellastock (FR), the Belgian Building Research Institute / BBRI (BE), Brussels Environment (BE), the Scientific and Technical Center of Building / CSTB (FR), Confederation of Construction (BE), Rotor (BE), Salvo (UK) and University of Brighton (UK).

The information contained in this document does not necessarily reflect the position of all the FCRBE project partners nor that of the funding authorities.

Unless explicitly stated otherwise, the content of these sheets is credited in the Creative Commons Attribution NonCommercial – Share Alike format (CCBY-NC-SA).



Unless explicitly stated, the images used in this document belong to © Rotor vzw/asbl or © Opalis. Any other image has been the subject of a systematic request for authorisation from their authors or rightful owners. When this request has not been answered, we assumed that there were no objections to the use of the image. If you feel that this interpretation is unreasonable, please let us know.





**Material description**

Natural stone elements are often used to cover the tops of walls (acroterion, gable, partition walls) to protect them from rain and humidity. Like other natural stone materials, wall copings and capings (also called covering stones) are suitable for reclamation: they are resistant, have beautiful finishes and lend themselves well to various transformations. They are commonly found on the reclamation market, in a multitude of models which often reflect historical regional specificities (blue stone in Belgium, Burgundy stone in central France, sandstone in the United Kingdom).

Several criteria make it possible to distinguish them:

→ *Geological nature.* Many types of rocks were used in the manufacture of coping stones. Among the most common on the reclamation market, we find granite, sandstone, limestone (blue stone or white stone) or slate, in all their local variations.

→ *Formats and dimensions.* Most often, reclaimed coping stones have widths between 25 and 60 cm, thicknesses between 4 and 20 cm and variable lengths. The maximum length of new coping stones is generally 155 cm. Besides the linear elements, there are also specific parts for angles, ends, etc.

→ *Profiles.* Different coping stone profiles can meet. Their main function being to ensure the flow of rainwater, they are generally (but not always!) inclined. Their slope can be unilateral or bilateral depending on the desired direction of flow. Generally, natural stone coping extends beyond the thickness of the wall (≈ 5 cm on both sides) and include a drip groove to keep runoff water away (Figure 1).

→ *Fixing.* Coping stones are generally installed on a full bed of mortar (with or without the addition of additives) without interlocking or overlapping.



Figure 1. Profile of a standardised natural stone wall coping.

1. Drip groove
2. Overhang
3. Inclined upper face

*Did you know ?*

A *coping* is a construction element that lays on top of a wall and comes down the sides of it, encasing the wall and providing weather protection. However, a *caping* sits on the wall with its edges flush to the width of the wall.



Flat wall coping  
© Architectural salvage



Sloped surface coping  
© Willmow Reclamation & salvage



Double inclined surface coping  
© Rotor DC



Cap coping  
© Olde School architectural antiques



Half round in yellow Brionnaise stone  
© Antic-Mat



Coping stone  
© Willmow Reclamation & salvage





## Natural stone wall copings

→ **Appearance.** The diversity of rocks is reflected in a wide range of colours, including within the same family: grey, beige, ochre, brown, pink, bronze, etc. A specific vocabulary is used to designate the stone inlays: veins, grains, strata, flames, stains, etc.

In addition to the original appearance of the rock, the coping stones can bear the marks of their cutting method (cleavage, sawing) and of their original finish (grinding, sanding, softening, chiselling, bush hammering, flaming, etc.). Over time, their appearance also varies according to the stresses of use: softening, polishing of the visible face, traces of paint, mortar, development of organisms (mosses, lichens.), etc.

When a re-machining of the reclaimed coping stones is envisaged (sawing, squaring, milling, etc.), this will generally modify the appearance of the visible faces.



Reclaimed red sandstone coping stones  
© [Willmow Reclamation & salvage](#)



Reclaimed granite coping stones  
© [salvoweb.com](#)



Reclaimed blue stone (limestone) coping stones  
© [Het arduinen hoekje](#)



Reclaimed white stone (limestone) coping stones  
© [BCA Matériaux Anciens](#)



Reclaimed slate coping stones  
© [salvageandstone.co.uk](#)



**Inspiration.** Flat coping stones cut from reclaimed Villebois blocks © [Antic-Mat](#)

**Material reclamation**

**Natural stone coping is a good candidate for reuse, either on-site or through the professional channels of material resellers. These suppliers can also ensure the supply of batches of coping stones ready for installation. They are able to ensure the smooth running of the following operations:**

→ *Disassembly test (or expert opinion)*. Makes it possible to ensure the feasibility and profitability of a removal. An “expert eye” generally makes it possible to estimate the interest of a batch based on photos or by an on-site visit. The focal points for coping stones will be among others:

- the general condition of the batch and the laying method: condition of the stone, formats and dimensions, nature of the laying bed, characteristics of the joints, etc.
- commercial interest, depending on the period, style, stone, condition, quantity in place, etc.
- logistics arrangements: especially in terms of deadline, working time, handling, transport, etc.

In order to more confidently determine the salvage potential of coping stones, a dismantling and cleaning test is usually performed on a sample.

→ *Removal*. The careful dismantling of coping stones must ensure the safety of the workers and the integrity of the recovered elements. The coping stones are first detached from the wall using mechanical or manual tools (hammer, jackhammer, pneumatic chisel, crowbar, etc.). Coping stones can be heavy due to their size and the density of the stone (> 2.5 t/m<sup>3</sup>). They can also be fragile, especially if they are thin (4-6cm) or if there are white grooves or veins on the surface of the stone. In the event of cracking or breakage, they lose a lot of their value. It is therefore advisable to equip oneself with specific means or call in a professional.

→ *Cleaning and sorting*. The salvaged coping stones will then be sorted by qualities, colours and dimensions. Cleaning with a brush and water as well as scraping with a suitable blade is generally sufficient to remove the residues of the laying layer, the jointing products, the residues of sealants and tar and the other elements which could adhere to them. However, mortars can bond tightly

and it is not always easy to remove them. Methods for repairing small cracks and breaks can be considered to restore damaged elements.

→ *Operations*. While some coping stones can be reused as is after a rough cleaning, others may require additional operations such as:

- *Sawing*: the ends of the coping stones can be sawn to obtain flat and vertical side faces, in order to standardize their dimensions.
- *Cutting and machining*: the profiles and edges of the coping stones can be re-worked.
- *Thorough cleaning*: the visible face of some more porous stones may be stained or have changed colour during use due to atmospheric pollution or the growth of mosses. Their restoration to original condition is not always possible. It depends on the depth of encrustation, which varies according to the type of pollution and the type of stone. It is advisable to contact a professional to know the compatible products and the appropriate treatment methods. Several techniques are possible (on site or in a workshop): water polishing, use of chemicals (oxalic acid, polishing chemicals, polishers), mechanical cleaning (sanding, polishing) or even, in very specific cases, use of laser, latex or poultices.

The choice of a suitable cleaning technique will depend essentially on the following aspects: nature and hardness of the stone, fineness of its grain and other surface aspects, presence of alterations, type and degree of soiling, desired result.

- *Finishing*: to meet the desired requirements (uniform appearance, rough or smooth appearance, etc.) several techniques are possible depending on the nature of the stone and the expected performance: bush hammering, sanding, flaming, shot blasting, pitting, etc. A specific vocabulary determines the type of finish depending on the type of rock concerned.

These various operations can be carried out by specialised resellers within their facilities. They can also be considered on site, provided that the site logistics allow it.



Sealant and tar residues © [auctelia](#)



Development of organisms © [Willmow Reclamation & salvage](#)

→ *Storage and packaging*. Coping stones are generally stored outside, packaged and strapped on pallets. They are arranged horizontally. Ideally, they are separated by wedging elements in order to limit the risk of damage. The wedges/separation wood must not be treated, be very dry and not contain tannins which could stain the stones. Metal straps should be avoided as there is a risk of staining the stone (rust). The packaging must take into account the large mass of the elements. Appropriate means of transport and lifting are also required.

Reclaimed natural coping stones are generally sold by the linear metre or by the piece. Most suppliers are able to provide a technical sheet showing their main characteristics: type of rock, nominal dimensions and tolerances, finish, intended applications and, in certain cases, their origin.





## Applications and installation

**Reclaimed coping stones can be re-used in their original function or reused for other applications: door and window sills, exterior flooring, stair treads, benches, etc.**

For identical use, the main points of attention related to the installation of reclaimed coping stones do not differ from those linked to new coping stones - in particular, and in a non-exhaustive way: type and dimensions of the elements, type of laying layer, type of jointing, coping stone profile and incline, presence of drip groove, expansion joint, anchor, etc.

It is up to the specifiers to rely on the regulations in force in this field, on the rules of the art and on the European and national standards relating to the stone products. Furthermore, adequate installation requirements must be specified to cover the wide variety of possible applications of reclaimed coping stones.

In general, finding a batch with very specific characteristics can be complicated. It is often preferable to identify a batch of raw reclaimed coping stones and to consider additional processing operations. The expertise of professionals can be invaluable in this regard.

The following characteristics can be described and specified when drafting the technical requirements related to the delivery of a batch of reclaimed coping stones:

→ **Batch composition.** The batch consists of reclaimed coping stones of the same type (same profile), the same geological nature or even the same origin of use (area subject to frost, etc.). However, mixed coping stone batches may be suitable for less demanding applications.

→ **Format.** The identified batch must correspond to the specificities of the project. In general, the dimensions must be uniform in thickness and width greater than that of the wall to be covered. Depending on the design, the batch can be split into sub-batches of different dimensions. To limit costs and facilitate the identification of recovered coping stone batches, it is preferable to be flexible enough on the dimensions by opting for a free-length installation, by defining only a minimum length (for example, min. 40 cm) or by setting a fairly wide gap (for example, length between 80 and 120 cm). If necessary,

it is also possible to insist on more precise dimensional characteristics (as well as tighter dimensional tolerances). This may result in a heavier transformation of the material (sawing, re-machining).

→ **Profile.** If necessary, the profile (flat, unilateral or bilateral slope, etc.), the condition of each edge (straight sawn, chamfer, rounded, without requirement, etc.), the degree of inclination and the dimensions of the drip edge should be specified. These characteristics may be given approximately (for example, thickness > 5 cm, height difference > 5%, etc.) or defined more precisely.

→ **Texture and finish.** Depending on the requirements (functional and aesthetic) and the type of rock, the appearance of the visible faces (sawn, ground, bush hammered, flamed, scabbled, shot peened, etc.), non-visible faces and ends (sawn, cleaved) should be specified.

→ **Hue.** By nature, natural stones have a wide variety of colours and appearances. Depending on usage requirements (for example, in the context of heritage renovation), it is possible to specify this characteristic by referring to a general hue or to a specific colour.

→ **Condition.** In addition to traces of mortar and paint residues, reclaimed coping stones may show minor alterations such as signs of surface wear, chips, light cracks, craters, light flaking, stains, leftover moss, earth, etc. These deteriorations can influence the technical and aesthetic performance of the coping stones, as well as their re-installation, but do not constitute a major obstacle to reclamation (see "Characteristics and fitness for use"). Depending on the nature of the rock, other aspects can be considered as major imperfections. For example, certain limestone rocks (i.e. blue stone) may have stylolitic joints liable to weaken the stone. To a large extent, the existing technical documentation makes it possible to assess these various aspects on a case-by-case basis. Professionals can also be consulted. It is up to the specifier to define the degree of imperfection tolerated, according to the defined use and the installation conditions, by specifying the degree of acceptable alterations (for example: chips, cracks and flaking < x cm<sup>2</sup> tolerated on visible sides, broken corners and edges tolerated on invisible parts, etc.).

Most professional suppliers are able to ensure that delivered batches meet these requirements. A control test procedure

based on a contractual sample and sampling upon receipt can be set up.

Most of the reclaimed building materials are sold as is. The conditions of sale may however contain special guarantees specific to the material. Some suppliers are able to indicate the origin of the material and/or provide documentation on the product purchased (for more information, see the *Introductory sheet*).



Coping stone (with overhang)

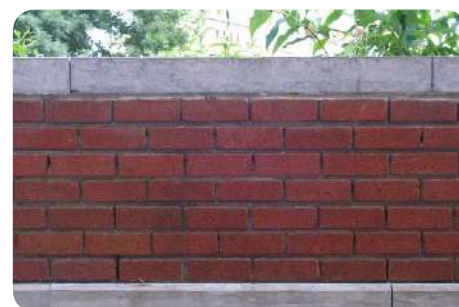

Coping stone (without overhang)

### Design tip!

*It is better to order a quantity expressed in linear metres rather than in number of pieces, given the irregular lengths of the reclaimed coping stones.*





### Characteristics and fitness for use

By knowing the family or the type of stone present, it is generally possible to find its general characteristics. These indications are invaluable for studying the compatibility of the reclaimed stone for the intended use.

See for example: [www.febenat.be](http://www.febenat.be) ; [www.stonenaturelle.fr](http://www.stonenaturelle.fr) ; [www.pierreetsol.com](http://www.pierreetsol.com) ; [www.cstc.be](http://www.cstc.be) ; etc.

As an indication, the following table (*Table 1*) shows some of the known performances of some types of rock constituting coping stones which are frequently reclaimed. It is important to point out that each stone has its own characteristics and that two batches of coping stones of the same rock can however have quite different performances.

There is no harmonized standard specific to coping stones, but several standards and test methods make it possible to determine the properties relating to natural stones (EN 12407 - Petrographic examination, EN 1936 - Determination of real density and apparent density, and of total and open porosity, EN 12371 - Determination of frost resistance, etc.). Although they relate to new materials, these documents can be useful in characterizing reclaimed coping stones (*Table 2*).

*Table 1 : Technical characteristics of the most common stones used in coping stones*

	<b>Bulk density (kg/m<sup>3</sup>)</b>	<b>Porosity</b>	<b>Wear resistance</b>
<b>Sandstone</b>	2000 - 2700	little porous (0.5 to 10%)	good to very good
<b>Soft limestone (e.g. white stone)</b>	< 2500	porous (5 to 50%)	good
<b>Compact limestone (e.g. bluestone)</b>	> 2500	little porous (0.2 to 5%)	good
<b>Granite</b>	2500 - 3000	very little porous (0.2 to 2%)	very good
<b>Slate</b>	2600 - 3000	very little porous (< 3%)	/

*Table 2 : Characteristics to be evaluated in order to determine the fitness for use of reclaimed natural stone wall copings*

<b>Characteristics</b>	<b>Comments</b>
<b>Geological origin and petrographic description</b>	The reclaimed coping stones come from works that may have been made from batches of multiple origins. If it is possible to visually identify the type of rock present, it is however more difficult to affirm with certainty that their geological origin is identical, unless there are records that allow it to be attested (for example: a certificate of origin, archival documents, etc.). This is all the more true for the batches made up of elements of various origins.
<b>Geographical origin</b>	As with the geological provenance, information on the original geographic provenance of a batch of reclaimed coping stones is difficult to certify with any certainty. On the other hand, we can deduce certain characteristics if we know where the coping stones were removed. Thus, in the absence of information on the original quarry, it may be useful to have information on the original use or the area where the elements come from.
<b>Geometric characteristics</b>	These characteristics can be found out by taking simple measurements. They are closely linked to the degree of sorting and cleaning of the reclaimed coping stones as well as to the transformation operations undertaken on the material. In the case of coping stones intended to be re-machined or re-cut, it is advisable to define with the supplier the dimensional tolerances applicable to each of the dimensions (width, thickness, length, etc.) the type of stone and the functionality of the works. The requirements in terms of flatness, straightness, dimensions of the drip edge and the desired degree of slope should also be detailed.
<b>Bulk density and open porosity</b>	<p>These characteristics are specific to each stone. The density [kg/m<sup>3</sup>] gives an indication of the degree of compactness of the stone. In general, the more compact a rock, the less porous it is.</p> <p>The open porosity of a stone [% by volume] corresponds to the proportion of pores connected to each other and accessible to water. This characteristic influences in particular the degree of resistance to stains and soiling. It does not directly affect its freezing (it is rather its capacity to return the absorbed water that matters at this level).</p> <p>This information can be estimated based on technical documentation relating to natural stones (<i>see Table 1</i>). If necessary, these characteristics can be measured more precisely by an identity test as defined by the test EN 1936).</p>



Characteristics	Comments
<b>Resistance to freezing/thawing (and de-icing salts)</b>	For an exterior application, the natural stone elements must be able to withstand freezing/thawing without their appearance or their mechanical characteristics being affected. The source and condition of a batch of reclaimed coping stones can provide a useful guide to determining their resistance to freezing/thawing. Many old coping stones are in fact likely to have withstood, during their first use, more freeze/thaw cycles than what is recommended by the test standard which allows this performance to be assessed (EN 12371). It is therefore important to find out about the geographical origin of the batch to ensure the original climatic conditions (for example, a batch coming from a continental climate in northern Europe will probably be suitable for an application in the Mediterranean climate of the South of France). Generally, less resistant coping stones that have suffered frost damage will probably have been discarded during the sorting and cleaning steps.
<b>Reaction to fire</b>	In accordance with Commission Decision 96/603/EC, natural stones are considered to belong to class A1 of reaction to fire (see EN 12 058 for exceptions). However, be careful with the use of filler sealants, which can affect this performance.
<b>Susceptibility to staining</b>	<p>To assess this characteristic, we differentiate between internal staining caused by the reaction of certain constituents of the stone (metallic minerals or organic materials present in the stone), from accidental staining caused by contact with a staining product.</p> <p>Internal staining is first and foremost an aesthetic concern for the material and it is therefore appropriate for the project developer to define the acceptable characteristics with regard to the intended use.</p> <p>The sensitivity to staining is also directly related to the porosity value of the stone. The higher the porosity, the more easily the stone absorbs liquids and pollution, the more sensitive it is to staining. A porosity of less than 4% is generally satisfactory in order to limit the risks of soiling. It is also possible to visually identify the degree of soiling of the reclaimed wall copings by observing the visible face of the unprocessed (sawn) elements. Where appropriate, there are surface treatments to improve this performance by slowing the infiltration of greasy substances into the stone's pores.</p>
<b>Resistance to impact</b>	The impact resistance of a hard body depends on the characteristics of the stone but also on its installation method and its substrate. The test described in standard EN 14158: 2004 consists in dropping a steel ball on the element installed in its actual conditions of use. For reclaimed coping stones, we can also rely on the condition of the elements still installed. If many coping stones subjected to similar loads are broken, it can be assumed that even intact coping stones are liable to break in turn. These coping stones alone should not be removed without minding all the information on the condition of the batch.
<b>Thermal deformation</b>	Natural stone is subject to dimensional variations under the effect of temperature. This deformation is expressed in [mm/mK] by the coefficient of thermal expansion. In the case of coping stones subjected to large temperature variations, it may be relevant to determine its extent (EN 14581: 2005). In certain marbles and, to a lesser extent, certain granites, the anisotropic thermal expansion of the stone causes granular decohesion resulting in significant deformation of the blocks.



Blue stone exterior coping stones reused for the creation of a terrace, Brussels (BE) © VLA architecture  
<https://www.guidebatimentdurable.brussels/fr/reemploi.html?DC=10994>



**Availability**

Professional suppliers of reclaimed stone materials generally have batches of varying quantities of coping stones. The quantities found can range from a few metres (<10 m) to a hundred linear metres. For larger quantities, stock should be checked with suppliers well in advance.

**Indicative prices (Excl. tax):**

A non-exhaustive sampling of the reclamation market in North West Europe (Belgium, France, Great Britain and the Netherlands) made it possible to extract some indicative prices. The price of a coping stone (expressed in linear meter) varies depending on the availability of the size and type of stone, as well as the degree of sorting and cleaning requested.

- Thin coping stone (<10 cm): ~ 30-50 €/lm
- Thick coping stone (> 10 cm): ~ 60-200 €/lm
- Cutting: ~ 40 €/h for cutting the stone

**Find specialised businesses**

**SALVO** **OPALIS**  
salvoweb.com opalis.eu

[salvoweb.com](http://salvoweb.com) [opalis.eu](http://opalis.eu)



Reusing old coping stones for window sills © Sophie Boone

**Did you know?**

Some suppliers of reclaimed stone items also offer new product lines, some of which are artificially aged to give them the appearance of a used product. If in doubt, find out where the materials are coming from, in order to be sure of their reclaimed origin.

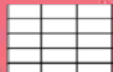

**Disclaimer**

This sheet is intended for designers, specifiers and other members of construction project teams wishing to reuse this building material or product. It is part of a collection of sheets aimed at bringing together the available information to date that is likely to facilitate the reuse of building materials and products.

This sheet has been produced by Rotor vzw/asbl within the framework of the Interreg FCRBE project - Facilitating the Circulation of Reclaimed Building Elements, supported by the entire project partnership. Sources of information include the experience of reclamation dealers and involved project partners, lessons learned from exemplary projects, available technical documentation, etc.

The sheets have been produced between 2019 and 2021. As the reclamation sector is evolving, some information, notably regarding pricing and availability, may change over the time. When the text refers to European standards, it is up to the project team to refer, if necessary, to their national implementations and local specificities.

It is important to note that the information presented here is not exhaustive or intended to replace the expertise of professionals. Specific questions are always project related and should be treated as such.

The complete collection of sheets (including the introductory sheet) is freely available from different reference websites (a.o. [opalis.eu](http://opalis.eu), [nweurope.eu/fcrbe](http://nweurope.eu/fcrbe), [futureuse.co.uk](http://futureuse.co.uk)).

Non-exhaustive directories of dealers in reclaimed building materials are available on [www.opalis.eu](http://www.opalis.eu) and [www.salvoweb.com](http://www.salvoweb.com).

---

Interreg FCRBE partnership: Bellastock (FR), the Belgian Building Research Institute / BBRI (BE), Brussels Environment (BE), the Scientific and Technical Center of Building / CSTB (FR), Confederation of Construction (BE), Rotor (BE), Salvo (UK) and University of Brighton (UK).

The information contained in this document does not necessarily reflect the position of all the FCRBE project partners nor that of the funding authorities.

Unless explicitly stated otherwise, the content of these sheets is credited in the Creative Commons Attribution NonCommercial – Share Alike format (CCBY-NC-SA).



Unless explicitly stated, the images used in this document belong to © Rotor vzw/asbl or © Opalis. Any other image has been the subject of a systematic request for authorisation from their authors or rightful owners. When this request has not been answered, we assumed that there were no objections to the use of the image. If you feel that this interpretation is unreasonable, please let us know.

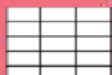

**Material description**

Stone has always been used and re-used in construction, in particular to cover exterior façades and interior walls. In his architectural treatise published in 1485 (*De re ædificatoria...*), Alberti already speaks of the use of stone to build what he calls “the skin” or “the bark” of buildings, that is to say the exterior and interior faces of the walls of which, he says, “... one receives the wind and the sun on the outside, while the other protects the interior shade ...”. Although the terminology has changed since the 15<sup>th</sup> century, we still use stone for the same purpose. A distinction is made today between the stone wall covering slabs and veneers (or tiles). The latter are thinner and smaller in size. Thicker and larger elements fall into the category of facing stones, which are usually laid with other techniques.

This sheet covers the reclamation of natural stone slabs intended for use in wall cladding. It is also possible to reuse the slabs elsewhere, as flooring for example (see the sheet dedicated to natural stone flagstones).

The market for reclaimed wall tiles includes a very wide variety of products. We can separate them according to different criteria:

→ **Original use.** Some batches come from the façades of office buildings and other large public and private facilities (e.g. stations, banks, etc.). The demolition of these buildings generally results in the release of large quantities of similar slabs, often in excellent condition and of good quality. Other slabs are the result of the careful dismantling of window sills, flooring, etc. from various types of buildings, including older structures.

→ **Geological nature.** Many types of rocks are used for the manufacture of wall facing slabs: granite, marble, limestone, sandstone, slate, travertine and many others, all available according to many local variations.



Chamfered edges  
© Pierre de Bourgogne



Chipped edges



Sharp edges

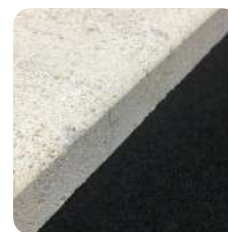

Rounded edges

→ **Dimensions.** Usually, reclaimed slabs have widths and lengths between 30 and 150 cm and thicknesses between 1 and 8 cm. However, it is not uncommon to find elements with more specific dimensions.

→ **Appearance.** The diversity of rocks is reflected in a wide range of colours, including within the same family: grey, beige, ochre, brown, pink, bronze, etc. A specific vocabulary is used to designate the stone inlays: veins, grains, strata, flames, stains, etc.

In addition to the original appearance of the rock, the slabs can bear the marks of their cutting method (cleavage, sawing) and of their original finish (flaming, sanding, shot blasting, bush hammering, polishing, etc.). Over time, their appearance also varies according to the stresses of use: softening, polishing of the visible face, darkening of the hue, traces of paint or mortar on the underside, growth of organisms (mosses, lichens), etc.

The treatment of the surface of certain types of stones may require the use of putty, fillers or other similar products for plugging natural holes, defects or cracks. These treatments

are often not specific to reclaimed stone but also apply to new products.. Sometimes, an anti-graffiti treatment is present (e.g. tiles from the feet of a building).

The edges of the slabs can be straight, rounded, chipped or even chamfered.

When a re-machining of the reclaimed slabs is envisaged (sawing, squaring, milling, etc.), this will generally modify the appearance of the visible faces.



Polished grey granite slab



Carrara marble slab



Shower room made of reclaimed red marble  
© Séverin Malaud

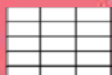

→ **Fixation.** The slabs may have been bonded or fastened.

- Bonding is generally reserved for thinner slabs (1 to 2 cm thick, depending on the density of the stone).
- Mechanical fasteners are suitable for thicker slabs (2 to 8 cm). There are several types: metal clips with or without stud, fixed to an intermediate frame or directly into the wall. Non-destructive methods such as the use of a pachometer make it possible to locate the metal anchoring elements without dismantling the slabs.

→ **Geological nature.** Depending on the type of installation, the presence or not of an insulation, the location of the slabs and the height of the building, we may encounter common solid joints (mortar, grout, epoxy, etc.), flexible control joints or horizontal and vertical expansion joints (epoxy, sealant, etc.) or even hollow joints, left empty or decorated with metallic elements.



Stone cladding fixed with metal clips embedded in mortar studs



Searching for metallic anchoring elements of a natural stone facing using a pachometer. © CSTC



Fastened stone cladding



Full joint



Hollow joint filled with metal elements



Hollow joint



Shower room made of reclaimed marble © Lionel Billiet





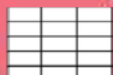

**Material reclamation**

**Natural stone wall coverings are a good candidate for reuse, either on-site or through the professional channels of material resellers. They can also ensure the supply of batches of slabs ready for installation. They are able to ensure the smooth running of the following operations:**

→ *Disassembly test (or expert opinion).* A disassembly test makes it possible to ensure the feasibility and profitability of a removal. An “expert eye” generally makes it possible to estimate the interest of a batch based on plans, photos, historical documents or by an on-site visit. The focal points for slabs will be among others:

- the general condition of the batch and the laying method: condition of the stone, formats, dimensions fixing type, type of laying bed, characteristics of the joints, etc.
- commercial interest, depending on model, quantity, salvage and resale potential, specific regional particularities, etc.
- logistics arrangements: especially in terms of deadline, working time, handling, transport, etc.

→ *Removal.* Careful dismantling should aim to ensure the integrity of the slabs and a certain uniformity of the batches. When the joints between the slabs are full, it is sometimes advisable to separate the slabs using tools (diamond saw on a rail, pressurized water, etc.) and handling means suitable for the covering to avoid splintering. Then the slabs can be laid. (Figure 1) If the slabs are fixed using a mechanical anchor, it is advisable to break a first slab to create an access then to break the mortar stud (1) surrounding the metal fasteners (2 & 3) using a chisel.

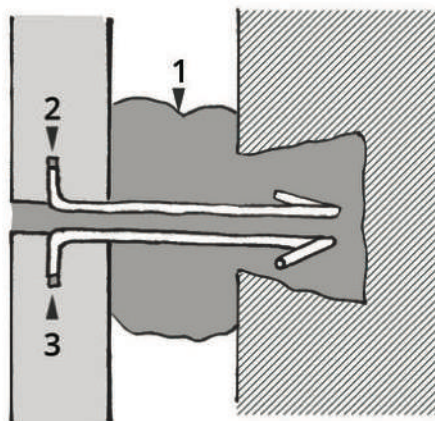

(1) Mortar stud  
(2) Load-bearing clip  
(3) Anti-buckling clip

Figure 1. Mortar-embedded fasteners in the edges of the slabs

It is then necessary to remove the fasteners using the chisel or a crowbar or to disconnect them at the joints. To minimise the risk of deterioration during dismantling, it is advisable to weaken the tensions within the slabs by first freeing 2 sides (perpendicular) of the tiles to be detached. This usually involves breaking non-free edge lines. It is advisable to proceed with the disassembly from top to bottom. In addition, some slabs can be particularly heavy due to their size and the density of the stone (> 2.5 t/m<sup>3</sup>). If necessary, it is advisable to equip oneself with specific lifting means. Removal may also involve making arrangements for work at height. Finally, a sand bed can be installed at the foot of the slabs to absorb shocks.

→ *Cleaning and sorting.* The slabs will be sorted by quality, colour, size and degree of cleaning. Elements showing deterioration (split slabs) or significant defects are discarded. The rate of loss strongly depends on the type of rock, the original conditions of use, the type of installation, the thickness of the slabs and the care taken in dismantling. Cleaning with water or by scraping is generally sufficient to remove laying residues, jointing products and other elements which could adhere to it. The metal fasteners are also removed.

→ *Operations.* While some slabs can be re-used as is after a rough cleaning, others may require additional operations such as:

- *Sawing:* the slabs can be sawn to make their dimensions consistent and facilitate their installation.
- *Thorough cleaning:* the visible face of some more porous stones may be stained or have changed colour during use due to atmospheric pollution, the passage of users or even the growth of moss. Their restoration to original condition is not always pos-

sible. It depends on the depth of encrustation, which varies according to the type of pollution and the type of stone. It is advisable to contact a professional to know the compatible products and the appropriate treatment methods. Several techniques are possible: water polishing (different pressures and temperatures), use of chemicals (oxalic acid, polishing chemicals, polishers), mechanical cleaning (sanding, polishing, sandblasting, projection of fine particles, micro-sanding, etc.) or even, in very specific cases, use of laser, latex or poultices.

The choice of a suitable cleaning technique will depend essentially on the following aspects: nature and hardness of the stone, fineness of its grain and other surface aspects, presence of alterations, type and degree of soiling, desired result, etc.

- *Finishes:* it is very rare for reclaimed slabs to undergo a surface treatment in the workshop since in general the desire is to keep their patina. However, to meet the desired requirements (standardize the appearance of the stone, give it a rough appearance, etc.) several finishing techniques are possible depending on the nature of the stone and the expected performance: bush hammering, sanding, flaming, shot blasting, pitting, etc. A specific vocabulary determines the type of finish depending on the type of rock concerned.
- *Repair of lug/clamp holes:* the existing holes may have been damaged during use or during the removal of the slabs (chip, crack, widening of the holes, etc.). In this case, the visible holes can be filled with a suitable product and new holes can be drilled in the workshop (respecting the positioning and strength of the new fasteners prescribed by the technical standards relating to the product).

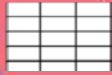

→ *Storage and packaging.* The slabs are generally stored outside, arranged on their edge in wooden crates or packaged horizontally and strapped on pallets. Depending on the fragility of the slabs to be kept, they will be sheltered by avoiding contact with the ground and by providing for possible protection against frost. Ideally, they are separated by wedging elements in order to limit the risk of damage. The wedge/separation wood must not be treated (it must be very dry and not contain tannins liable to stain the stones) and metal straps should be avoided as there is a risk of staining the stone (rust). The packaging must take into account the large mass of the elements. Appropriate means of transport and lifting are also required.

The ready-to-install reclaimed slabs are grouped together in uniform batches. They are generally sold by batch or per m<sup>2</sup>. Most suppliers are able to provide a technical sheet showing their main characteristics (type of rock, nominal dimensions and tolerances, finish, intended applications) and, in certain cases, their origin.

**Point of attention!**

*Thinner façade slabs in metamorphic marble can be subject to granular decohesion which can lead to the bowing of the elements, their cracking and causing a risk of falling. This phenomenon is accentuated for façades subject to rain and sun (south, south west) and for large, very thin slabs. It often leads to cracks at the anchors. A detailed visual inspection will usually reveal this problem. A more in-depth analysis of the microstructure of the stone also makes it possible to observe this phenomenon.*



Bowed slabs. Alvar Aalto's Finlandia Hall, Helsinki  
© University Of Helsinki



Marble slab wall covering



Fixing by hooks



Cutting fasteners



Removal of marble slabs



Palletizing slabs



Loading and transporting slabs



Removal of grout residues from the edge using a lapidary machine



Storage of slabs



Refitting the slabs on exterior facing, Project Jaspar,  
Architect Guillaume Sokal, Brussels (BE).  
© Guillaume Sokal



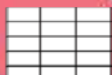

### Applications and installation

The applications presented here relate to stone slabs which were used as wall cladding and which are used for identical purposes. Other uses are of course possible for these elements (for example: splashback, floor covering, etc.) but they are not examined here (see for example the sheet devoted to natural stone flooring slabs). The case of reusing a stone slab from another application as wall cladding is not explicitly broached in this sheet either.

As a rule, the choice of slabs must necessarily take into account the expected stresses (see § "Characteristics and fitness for use").

On the façade, the main stresses are the own weight of the natural stone and the effects of the wind, but other factors must also be taken into account (climate action, thermal shocks, vibrations, impacts, etc.). In all cases, reference should be made to the design standards (Eurocode 1), to national and European standards relating to products (EN 1469: natural stone wall covering slabs), to the rules of art in force and the applicable installation standards.

The installation of a complete batch of reclaimed wall covering slabs in good condition is no different from that of new slabs. Depending on the characteristics of the batch, they lend themselves to the same diversity of installation methods and raise the same points of attention, in particular: format of the elements, properties of the stone, installation method and properties of the installation elements (fasteners or binders), property and condition of the substrate, insulation, waterproofing, common joints and control joints, stone defects at the attachment points (cracks, chips), stone surface condition (greasy stains, oxidation stains, runs, etc.).

The following characteristics can be described and specified when drafting the technical requirements related to the delivery of a batch of reclaimed slabs:

→ *Batch composition.* The batch of reclaimed slabs consists of elements of the same geological nature (granite, marble, limestone, etc.), or even of the same original use (interior use, area subject to frost, etc.). It is advisable to define one batch as a surface to be covered with the same application. However, mixed slab batches may be suitable for less demanding applications.

→ *Thickness.* The thickness of the wall slabs affects their mechanical behaviour. It must be chosen taking into account several criteria: nature and texture of the rock, intended use, format, positioning, installation and anchoring process, type and intensity of the stresses (wind, vibrations, shocks, humidity, thermal deformations, creep and shrinkage of the framework, etc.). In most common cases, for soft and semi-hard limestone (density <math><2500 \text{ kg/m}^3</math>) mechanically attached, a thickness of 4 cm is generally considered necessary. It can be reduced to 3 cm for denser stones (marble, granite, hard stone, etc.), or even to less than 2 cm in very specific conditions (hard and homogeneous rock, good quality grip, proximity to a rigid stopping point in the event of a fall, etc.). These must then be justified by specific procedures. Conversely, for a bonded installation, the slabs must be between 1 and 2 cm thick, depending on the density of the stone.

→ *Dimensions.* The dimensions of reclaimed slabs generally vary from batch to batch. Depending on the original application, they may also vary within the same batch. It is important to specify the expected dimensions as well as the dimensional tolerance. Good to know: the installation standards set different grip requirements depending on the surface of each slab, the proportion between their length and their width (typically in the order of 1:3 for outdoor use and up to 1:5 indoors) and the height at which they are installed (below 6 m, between 6 and 28 m, etc.). For slabs with atypical dimensions, specific approaches may therefore be necessary.

→ *Hue.* By nature, natural stones have a wide variety of colours and appearances. Depending on usage requirements (for example, in the context of heritage renovation), it is possible to specify this characteristic by referring to a general hue or to a specific colour. It's also possible to mix the tiles in order to obtain a uniform covering.

#### Think reversible!

Certain laying methods complicate or even prevent recovery of slabs. In this sense, as soon as possible and with comparable performance, it is best to use mechanical anchoring (hooks, clips, studs, etc.) for installation. And without joints or with easily cleanable joints!



Removal of interior facing slabs in granite



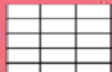

→ **Condition.** In addition to traces of mortar, paint and bitumen residues, reclaimed slabs may show minor alterations such as signs of surface wear, chips, light cracks, craters, light flaking, stains (runs, greasy stains, halos, oxidation) etc. These deteriorations can influence the technical and aesthetic performance of the slabs, as well as their re-installation, but do not constitute a major obstacle to reclamation - except for very specific uses (see § "Characteristics and fitness for use"). Where appropriate, certain surface treatments, or even cutting, can make it possible to correct these alterations.

However, the batch must not contain any elements with cracks or major damage that could compromise its solidity (for example cracks, chips or other defect in the stone at the level of the attachment points). The designer/specifier should define the degree of imperfections tolerated with regard to the intended use and the installation conditions.

Watch out for the holes in the old lugs/clips. Sometimes the slabs have worked loose so that the holes have become "craters". Sometimes mortar studs fill in the holes. The holes can be redone on site or in the workshop with suitable tools.

→ **Finishing.** Depending on the requirements (functional and aesthetic) and the type of rock, specify the appearance of the visible face and the edges of the slabs (rough, sawn, bush hammered, shot peened, flamed, polished, softened, etc.). Certain types of finish (rough sawn, scoured, etc.) make it possible to limit the absorption of solar energy from the façade. This phenomenon can be found in the case of dark bonded stone façades which under the effect of the sun can peel off and contribute to the creation of an urban heat island.

→ **Quantity.** Some suppliers may include surplus when the product is delivered if they are not able to guarantee the absolute uniformity of the characteristics mentioned above. This surplus can also be applied in the case of an on-site salvage scenario. It is generally advisable to provide a reserve stock of slabs in order to carry out subsequent repairs. Depending on the layout chosen, a greater or lesser percentage of the margin will be necessary because of the cutting brought about.

Most professional suppliers are able to ensure that delivered batches meet these requirements. A control test procedure based on a contractual sample and sampling upon receipt can also be set up.

Most of the reclaimed building materials are sold as is. The conditions of sale may however contain special guarantees specific to the material. Some suppliers are able to indicate the origin of the material and/or provide documentation on the product purchased (for more information, see the *Introductory sheet*).

**Design tip!**

*In general, the integration of reclaimed stones in the project is greatly facilitated if we plan:*

- a layout that tolerates slabs of various sizes, for example: a free-length stone-setting.
- a composition strategy for the recovered batches: either by mixing the batches to create a random distribution of shades of colours, or by assigning each batch of material to a particular space.



Above: lug hole intact  
Below: lug hole filled with mortar



Lug hole enlarged during removal



Lug hole enlarged during removal

**For more information!**

*Diagnostic and performance evaluation methodology for the reuse of attached natural stone façade cladding - Fondation Bâtiment (FR)*

Énergie, <http://www.batiment-energie.org/doc/70/FBE-ECB-enjeu-A-facade-V5.pdf>



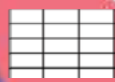

**Characteristics and fitness for use**

By knowing the family or the type of stone present, it is generally possible to find its general characteristics. These indications are invaluable for studying the compatibility of the reclaimed stone for the intended use.

See for example: [www.febenat.be](http://www.febenat.be) ; [www.stonenaturelle.fr](http://www.stonenaturelle.fr) ; [www.pierreetisol.com](http://www.pierreetisol.com) ; [www.cstc.be](http://www.cstc.be) ; etc.

As an indication, the following table (Table 1) shows some of the known performances of some types of rock constituting slabs which are frequently reclaimed. It is important to point out that each stone has its own characteristics and that two batches of slabs of the same rock can however have different performances.

The harmonised European standard EN 1469 establishes the relevant characteristics (according to the context) in order to determine the fitness for use of natural stone slabs intended for wall covering. Although detailed for new materials from the extractive and natural stone processing industry, these characteristics may prove useful in considering the specific case of reclaimed indoor/outdoor slabs (Table 2).

**Tip!**

*If the performance is to be determined by laboratory tests, a representative sample of the batch in question should be established. The number and dimensions of the samples to be taken depend on the type of test to be carried out. In order for the test results to be usable, the sampling procedure must be rigorous. A professional can assist you in this work to choose the samples and the tests to be carried out. For example, he will ensure that the properties of different samples subjected to identical stresses are assessed in order to obtain a representative mean value. The test procedures will be defined with regard to the previous and subsequent uses of the stone slabs.*

Table 1: Technical characteristics of the most common stones used in wall covering slabs

	<b>Bulk density (kg/m<sup>3</sup>)</b>	<b>Flexural strength (MPa)</b>	<b>Porosity</b>	<b>Wear resistance</b>
<b>Sandstone</b>	2000 - 2700	3 - 14	little porous (0.5 to 25%)	good to very good
<b>Soft limestone (e.g. white stone)</b>	< 2500	2-17	porous (5 to 50%)	good
<b>Compact limestone (e.g. bluestone)</b>	> 2500	2-17	little porous (0.2 to 5%)	good
<b>Granite</b>	2500 - 3000	8 - 25	very little porous (0.2 to 2%)	very good
<b>Marble</b>	2600 - 2900	8 - 22	very little porous (0.2 to 2%)	good

Table 2: Characteristics to be evaluated in order to determine the fitness for use of reclaimed natural stone wall covering slabs

<b>Characteristics</b>	<b>Indoor</b>	<b>Outdoor</b>	<b>Comments</b>
<b>Geological origin and petrographic description</b>	x	x	The reclaimed slabs come from building works that may have been made from batches of multiple origins. If it is possible to visually characterize the type of rock present, it is however more difficult to affirm with certainty that their geological origin is identical, unless there are records that allow it to be attested (for example: a certificate of origin, archival documents, etc.). This is all the more true for the batches made up of slabs of various origins.
<b>Geographical origin</b>	x	x	As with the geological provenance, information on the original geographic provenance of a batch of reclaimed slabs is difficult to certify with any certainty. On the other hand, we can deduce certain characteristics if we know where the slabs were removed. Thus, slabs in good condition that have been dismantled in an area subject to strong freeze/thaw cycles are likely to show good frost resistance. Thus, in the absence of information on the original quarry, it may be useful to have information on the original use (exterior façade, interior wall cladding) or the area where the slabs come from.
<b>Bulk density and open pores</b>	x	x	<p>These characteristics are specific to each stone. The density [kg/m<sup>3</sup>] gives an indication of the degree of compactness of the stone. In general, the more compact a rock, the less porous it is.</p> <p>The open porosity of a stone [% by volume] corresponds to the proportion of pores connected to each other and accessible to water. This characteristic influences in particular the degree of resistance to stains and soiling. It does not directly affect its freezing (it is rather its capacity to return the absorbed water that matters at this level).</p> <p>This information can be estimated based on technical documentation relating to natural stones (see Table 1). If necessary, these characteristics can be measured more precisely by an identity test as defined by the test EN 1936.</p>

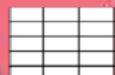

Characteristics	Indoor	Outdoor	Comments
<b>Geometric characteristics</b>	x	x	<p>These characteristics can be found out by taking simple measurements. Their homogeneity depends closely on the degree of sorting and cleaning of the reclaimed slabs as well as to the transformation operations undertaken on the material. In the case of slabs intended to be re-machined or re-cut, it is advisable to define with the supplier the dimensional tolerances applicable to each of the dimensions (width, thickness, length, etc.) the required pattern layout, the type of stone and the functionality of the works (these various aspects are described in standard EN 1469). The requirements in terms of flatness and straightness should also be detailed. For example, if the slab is secured with an adhesive mortar or thin layer of mortar, tighter tolerances may be required. Finally, some reclaimed metamorphic marble slabs may have undergone bending during their previous use. These slabs should be excluded with regard to their intended use.</p> <p>In general, raw reclaimed slabs show irregularities in shape related to the original manufacture and the degree of wear.</p>
<b>Flexural strength</b>	x	x	<p>The flexural strength <math>R_f</math> [MPa] is a mechanical characteristic which provides information on the capacity to resist bending forces in use. It varies according to the type of stone and is generally determined by means of bending tests as per standard EN 12372.</p> <p>The flexural strength makes it possible to determine the admissible breaking load [kN] of the slabs, according to their dimensions, and to the following formula:</p> $P = \frac{R_f \times W \times t^2}{1500 \times L \times F_s}$ <p>where <math>P</math> : breaking load [kN]</p> <p><math>W, L, t</math> : width, length and thickness [mm]</p> <p><math>R_f</math> : flexural strength [MPa]</p> <p><math>F_s</math> : safety factor, generally <math>F_s = 1.6</math></p> <p>For façade clipping applications, the flexural strength of the stone is rarely a problem. Rather, it is the resistance to the anchor studs that is decisive in responding to wind stress depending on the height of the building and the surface of the slabs. As a first estimate, it can be assumed that compact stones of moderate dimensions (<math>\approx 0.75 \text{ m}^2</math>) and thickness greater than or equal to 3 cm meet these requirements in most areas.</p>
<b>Resistance to fixings</b>	x	x	<p>The resistance to the fasteners must be demonstrated according to the test standard EN 13364. It must be at least equal to 200 N indoors and 300 N outdoors. Different justifications must be provided: strength of the anchor in the support, strength of the mechanical fastener, strength of the threaded rod, bending strength of the natural stone perpendicular to the façade, strength of the stone at the anchor pin. The first three criteria are generally given by the suppliers in the technical sheets. The resistance at the anchor pin can be determined by means of specific tests described in standard EN 13364.</p>
<b>Adhesion resistance (if bonding)</b>	x	x	<p>The adhesion strength and durability values depend on several important factors: the type of mortar/bonding, the surfaces to be bonded, the climatic conditions, etc.</p>
<b>Water vapour permeability</b>	x	x	<p>The water vapour permeability of a stone represents the amount of water vapour that passes through the material for a given vapour pressure and time. This characteristic should be evaluated if the slab is intended for use in an area subject to vapour control requirements. The coefficient of permeability can be determined by laboratory test or obtained from tabulated values in accordance with EN ISO 12572 and/or EN ISO10456.</p>
<b>Direct overhead sound insulation</b>	x	x	<p>The insulating quality of a wall depends both on the specific characteristics of the wall (rigidity, density) but also on the frequency of the sound emitted. It is characterized by the sound reduction index (measured in the laboratory) or the gross sound insulation (measured in situ). In general, the heavier a material (dense and thick), the more it insulates, in particular, against airborne noise. If required, this characteristic can be determined in the laboratory according to the test method of EN 1936.</p>



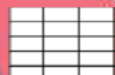

Characteristics	Indoor	Outdoor	Comments
<b>Thermal conductivity</b>	x	x	The thermal insulation power depends on the presence and size of the voids present in the material. Thermal conductivity is then defined as the amount of heat that passes through the material per unit of time and area. In general, the lower the density of the slabs, the greater the insulating power. If the slabs are to contribute to the thermal performance of a building, this characteristic can be determined in the laboratory according to the test method of EN 1745.
<b>Reaction to fire</b>	x	x	In accordance with Commission Decision 96/603/EC, natural stones are considered to belong to class A1 of reaction to fire (see EN 12 058 for exceptions). However, be careful with the use of filler sealants, which may affect this performance.
<b>Resistance to freezing/thawing (and de-icing salts)</b>		x	For an exterior application, the natural stone elements must be able to withstand freezing/thawing without their appearance and their mechanical characteristics being affected. The source and condition of a batch of reclaimed slabs can provide a useful guide to determining their resistance to freezing/thawing. Many old slabs are in fact likely to have withstood, during their first use, more freeze/thaw cycles than what is recommended by the test standard which allows this performance to be assessed (EN 12371). It is therefore important to find out about the historical and geographical origin of the batch to ensure the original climatic conditions (for example, a batch coming from a continental climate in northern Europe will probably be suitable for an application in the Mediterranean climate of the South of France). Generally, less resistant slabs that have suffered frost damage will probably have been discarded during the sorting and cleaning steps.
<b>Thermal shock resistance</b>		x	Resistance to thermal shocks is the stone's ability to withstand rapid changes in temperature (a façade that has a lot of sun and is then exposed to rain, for example). The latter can cause possible damage to the thin façade coverings: cracks generally localized at the level of the breaks (veins, stylolithic joints, etc.), microcracks between the grain of the rock causing intergranular decohesion, the bending of certain elements (e.g. in marble and marble limestone). As for the previous section, many old slabs are likely to have withstood more thermal shock cycles during their first use than what is recommended by the test standard (EN 14066). A visual examination of the slabs helps to remove damaged elements.
<b>Resistance to thermal and humidity cycles</b>		x	For an exterior application, the crystalline marble elements must be able to justify their good resistance to granular decohesion through a test of resistance to thermal cycles and humidity. As for the previous section, many old slabs are likely to have withstood more thermal and humidity cycles during their first use than what is recommended by the test standard (EN 16306). A visual examination of the slabs will rule out invalid slabs.
<b>Susceptibility to staining</b>	x	x	<p>To assess this characteristic, we differentiate between internal staining caused by the reaction of certain constituents of the stone (metallic minerals or organic materials present in the stone), from accidental staining caused by contact with a staining product.</p> <p>Internal staining is first and foremost an aesthetic concern for the material and it is therefore appropriate for the project developer to define the acceptable characteristics with regard to the intended use.</p> <p>The sensitivity to staining is also directly related to the porosity value of the stone. The higher the porosity, the more easily the stone absorbs liquids and pollution, the more sensitive it is to staining. A porosity of less than 4% is generally satisfactory in order to limit the risks of soiling. It is also possible to visually identify the degree of soiling of the reclaimed slabs by observing the visible face of the unprocessed (sawn) elements. Where appropriate, there are surface treatments to improve this performance by slowing the infiltration of greasy substances into the stone's pores.</p>

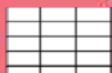

**Availability**

The supply of reclaimed natural stone wall covering slabs is relatively variable. The size of the batches can fluctuate from a few dozen to several hundred square metres. For large orders, it is recommended to check early enough with professional suppliers.

**Hazardous substances and precautions**

Some exterior stones may have come into contact with dangerous substances (pollution, graffiti, urine, etc.) that they may have absorbed, especially if they are porous stones. In the absence of more precise information on the subject, it is therefore recommended not to use them for applications in contact with food and people.

**Indicative prices (Excl. tax)**

A non-exhaustive sampling of the reclamation market in North West Europe (Belgium, France, Great Britain and the Netherlands) made it possible to extract some indicative prices. These may vary depending on the sources of supply, the types of slabs and the use of sorting and cleaning services.

- Slabs of random sizes in Burgundy limestone (thickness 2 to 4 cm): ~ 15 - 25 €/m<sup>2</sup>
- Red granite slabs: ~ 20 €/m<sup>2</sup>
- Paloma marble slabs (3 cm thick) in good condition but different sizes: ~ 50 €/m<sup>2</sup>
- Belgian blue stone slabs (3 cm thick), good condition, different sizes: ~ 120 €/m<sup>2</sup>
- Carrara marble slabs (87 × 84 × 5 cm) scratches and small chips possible, traces of angle grinder on the rough sides: ~ 160 €/m<sup>2</sup>

**Find specialised businesses**

**SALVO**  **OPALIS** 

[salvoweb.com](http://salvoweb.com) [opalis.eu](http://opalis.eu)

**Embodied carbon (Cradle to gate - production A1-A3)**

	kg CO <sub>2</sub> eq./m <sup>2</sup>	kg CO <sub>2</sub> eq./kg
OEKOBAUDAT (DE) database - Thinkstep individual data - Granite slabs *	31,8	0,6
OEKOBAUDAT (DE) database - Thinkstep individual data - Marble slabs *	16,3	0,3
OEKOBAUDAT (DE) database - Thinkstep individual data - Limestone slabs *	14,9	0,3

\* Indicative value for a façade cladding of 1 m<sup>2</sup>, 2 cm thick and with a basis weight of 52 kg/m<sup>2</sup>.



According to the sources and types of stone, reusing 100 m<sup>2</sup> of reclaimed natural stone wall covering slabs prevents the production of ~ 1490 to ~ 3180 kg of CO<sub>2</sub> equivalent related to the manufacture of new slabs (production phase only). According to sources, this corresponds to the emissions of a trip of ~ 9000 to ~ 19000 km in a small diesel car.



Reclamation of 5300 m<sup>2</sup> of red granite slabs from the façades of the Tour Cèdre in La Défense, Paris (FR). © Incomex <http://pierre-reemploi.com/offre/granit-rouge-de-facade-nr01/>





# WOODWORK



- Interior fire doors
- Interior door -  
Panneled wooden door





**Disclaimer**

This sheet is intended for designers, specifiers and other members of construction project teams wishing to reuse this building material or product. It is part of a collection of sheets aimed at bringing together the available information to date that is likely to facilitate the reuse of building materials and products.

This sheet has been produced by Rotor vzw/asbl within the framework of the Interreg FCRBE project - Facilitating the Circulation of Reclaimed Building Elements, supported by the entire project partnership. Sources of information include the experience of reclamation dealers and involved project partners, lessons learned from exemplary projects, available technical documentation, etc.

The sheets have been produced between 2019 and 2021. As the reclamation sector is evolving, some information, notably regarding pricing and availability, may change over the time. When the text refers to European standards, it is up to the project team to refer, if necessary, to their national implementations and local specificities.

It is important to note that the information presented here is not exhaustive or intended to replace the expertise of professionals. Specific questions are always project related and should be treated as such.

The complete collection of sheets (including the introductory sheet) is freely available from different reference websites (a.o. [opalis.eu](http://opalis.eu), [nweurope.eu/fcrbe](http://nweurope.eu/fcrbe), [futureuse.co.uk](http://futureuse.co.uk)).

Non-exhaustive directories of dealers in reclaimed building materials are available on [www.opalis.eu](http://www.opalis.eu) and [www.salvoweb.com](http://www.salvoweb.com).

---

Interreg FCRBE partnership: Bellastock (FR), the Belgian Building Research Institute / BBRI (BE), Brussels Environment (BE), the Scientific and Technical Center of Building / CSTB (FR), Confederation of Construction (BE), Rotor (BE), Salvo (UK) and University of Brighton (UK).

The information contained in this document does not necessarily reflect the position of all the FCRBE project partners nor that of the funding authorities.

Unless explicitly stated otherwise, the content of these sheets is credited in the Creative Commons Attribution NonCommercial – Share Alike format (CCBY-NC-SA).



Unless explicitly stated, the images used in this document belong to © Rotor vzw/asbl or © Opalis. Any other image has been the subject of a systematic request for authorisation from their authors or rightful owners. When this request has not been answered, we assumed that there were no objections to the use of the image. If you feel that this interpretation is unreasonable, please let us know.



### Product description

**Interior fire doors play an important role in passive fire prevention. While allowing the passage of users (and their evacuation in the event of a fire), they also compartmentalise buildings thus slowing the spread of a fire and allowing the intervention of the emergency services.**

The use of fire doors is made compulsory in a certain number of buildings such as office buildings and community facilities (community housing, schools, etc.). The nature of the doors, the performance thresholds they must reach and their location in buildings are governed by national provisions.

The reclamation of fire doors presents interesting challenges. In the context of buildings undergoing fairly short renovation cycles, it often happens that they are disposed of after only a few years of use while they are still in good condition (their reference lifespan is estimated at 30 years). Their composite nature makes them waste that does not recycle well. In this sense, their reclamation is of a certain environmental interest. Of course, they also touch on a very essential requirement of buildings which should not be taken lightly. To date, the reuse of fire doors has been implemented in several innovative projects.

*It is in fact the whole of the door unit which must prove its resistance to fire. For this, each constituent part plays a role.* For this, each constituent part plays a role:

- A. The *leaf* (or *door leaf*, that is to say the mobile part). This is generally in the form of a sandwich panel made up of layers of materials resistant to fire and humidity (wood, particles, steel, etc.) between which an insulating material is applied (mineral wool, plaster, perlite, cork, mineral fibre board, particle board, etc.). Likewise, any glazed elements of the leaf are made of fire-resistant glass. The leaf is generally fitted with a series of accessories such as handles, split hinges or hinges, locks, peepholes, etc.
- B. The *fixed frame*. This is made of a material that is sufficiently resistant to fire (steel, solid wood, glued laminated timber or wood-based particles). Depending on the model, it can be accompanied by a fan-light or a fixed glazing element.
- C. Fitting the frame to the wall also involves a *fire resistant gasket* (e.g. rock wool, fire enhanced polyurethane insulation foam, etc.).
- D. Added to this is the principle of adding *intumescent* (or swelling) materials to the leaf structure, to the frame, around the lock and to certain accessories (for example, ventilation grilles). When exposed to heat, these products swell and thus prevent the passage of hot gases and fumes. This phenomenon is also generally accompanied by an endothermic reaction allowing the absorption of heat.
- E. In addition, these doors are generally equipped with a *closing mechanism* that either automatically closes the door each time it is opened or automatically closes it when a fire is detected, although they can be opened to allow evacuation if necessary. These mechanisms can be simple door closers, electromagnetic magnets, thermal fuses, or even panic bar principles.



Example of a fire door

- F. Finally, proper installation and careful maintenance of equipment are essential to ensure the desired fire resistance.

Beyond these main principles, there is a very wide variety of fire door models. They are mainly categorised according to the materials used for the leaf and the frame, the number of leaves (one or more), the opening principle (hinged, pivoting, swinging, sliding), the opening direction (left or right), the closing mechanism in case of fire (automatic, door closer) or the original manufacturer. Fire doors can generally be identified by the conformity sticker located on the edge of the leaf (hinge side) and which mentions their fire resistance performance.



Electromagnetic pad



Intumescent band



Compliance sticker



Automatic door closer

**Product reclamation**

**Currently, it is mainly the leaf of fire doors that is recovered for reuse. It is much rarer for the frame to also be recovered.**

This is mainly due to the fact that:

- the frames are often difficult to dismantle without damage. In addition, they are also more vulnerable and require excellent transport and storage conditions.
- the dimensions of the new location are not necessarily the same as those of the original location, which may involve alterations to the frame.
- in the event that the door unit is recovered in its entirety, the elements need to be kept together or correctly listed in order to avoid mixing up the elements, which calls for extensive logistics.

Fire doors can be reclaimed on site or be directed to professional reclamation channels. The operations related to the recovery of fire doors concern:

→ **Disassembly test** (or expert opinion). An "expert eye" generally makes it possible to estimate the potential for reclamation during an on-site visit or based on photos and technical information relating to the manufacturer, model, dimensions, presumed quantity or the remaining validity of the certificate of conformity. The focal points will be among others:

- the general condition of the batch. Is the framework recoverable? Are the elements in good condition (leaves, frames, locks, hardware, intumescent products, etc.)? What about the presence of compliance stickers and their validity?
- commercial interest (depending on model, quantity, possible repairs, resale potential, compatibility of parts, etc.);
- logistics arrangements (deadline, working time, difficulty in handling, transport, etc.).

→ **Removal.** Careful disassembly must aim to ensure the perfect integrity of the elements (either of the door unit as a whole, or only of the leaf and its accessories). Each element of the same door unit will be correctly listed. It is advisable to remove the free hinges, handle elements, lock cylinders and closing elements (door closers, electromagnetic magnets) to minimise the risk of damage during handling and storage. Lock housings, on the other hand, should be held in place so as not to damage the intumescent material around them. The parts will be sorted by models, qualities and dimensions. Please note, the bulkiness of certain fire doors requires specific lifting arrangements (it is not uncommon to encounter fire doors weighing 100 kg or more!).

→ **Storage.** The leaves are preferably stored on their edge in suitable racks, using suitable protections (foam strips, foam corners, intermediate sheets, etc.). If they are stored on their long side, it is better to orient the lock upwards. When the frames are also recovered, care must be taken not to bend them. For mono-block metal frames, a reinforcing slat (wooden) is generally necessary to secure the uprights and prevent their deformation. The parts are stored protected from frost, humidity and bad weather.

→ **Treatments.** Apart from a superficial cleaning of the elements, no specific treatment is generally provided by specialised operators in the reclamation sector. The return to conformity of a reclaimed fire door is generally done when it is refitted by the installer.



Hardware



Vertical storage

→ **Transport and delivery.** All necessary precautions must be taken in order to limit the deterioration of the elements: dividers, protections of the corners and edges, strapping of the parts... Here too, the heavy weight of some fire doors should be taken into account.

It is advisable to involve specialised professionals to ensure the smooth running of these operations.

Most of the reclaimed building products are sold as is. The conditions of sale may however contain special guarantees specific to the material. Some suppliers are able to indicate the origin of the product and/or provide documentation on the product purchased (*for more information, see the introductory sheet*).





### Characteristics and fitness for use

Before being placed on the market, *new* fire-resistant door sets almost always benefit from a control certificate and a technical opinion issued by an accredited body. This guarantees their fire resistance performance and their performance in conventional use, under defined installation conditions and for a set validity. This voluntary certification by producers is not obligatory (to date CE marking is not obligatory for interior fire doors too). It is accompanied by technical notices and installation instructions corresponding to the product tested.

The fire resistance of door sets is evaluated based on destructive tests on installed samples, according to the European test standard EN 1634-1+A1. Based on the results of the test report, the door unit system is then assigned a performance class according to the classification of European standard EN 13501-2 (or national standard still applicable, see box ). This classification takes into account the following parameters:

- R = Load bearing capacity or fire stability. Structural elements must not collapse in the event of a fire. This does not apply to fire doors which are non-structural separating elements.
- E = Fire resistance. No slit or opening must allow the passage of flames through the element for a set period of time.
- I = Thermal insulation. The door must minimise the spread of the fire by transferring heat which can ignite elements on the side not exposed to the fire.
- W = Propagation. The door must minimise the spread of the fire by transferring heat which can ignite elements on the side not exposed to the fire.



*Until 2016, each European country used its own standards system. For example: Rf 30 / Rf 60 in Belgium for door sets which are fire resistant for 30 or 60 minutes, WBD in the Netherlands, SF / PF / CF in France, FD in the United Kingdom.*

Fire doors are classified into four classes: EI1, EI2, E or EW. National regulations determine the required classes according to the type of buildings, the use of the premises, etc. For example, in Belgium, only class EI1 (the most severe) is authorised. Resistance duration requirements also apply (e.g. EI1 30, EI1 60, EI1 90, EI1 120; classification based on the rules specified in standard 13501-2). For certain applications (e.g. stairwell doors in multi-storey buildings), performance regarding smoke tightness can also be expected.

In addition to their suitability for fire resistance, fire doors must be able to meet the requirements for fitness for use as a conventional door. These relate in particular to dimensions, flatness, mechanical performance, acoustics, safety, manoeuvrability, durability, resistance to humidity stress, etc.

In the event of *reclamation*, the fitness for use of fire doors can be assessed according to several additional measures:

1. *Verification based on the original certificate of conformity.* When purchasing a door (or during inventory), it is important to check that the condition of the door corresponds to the indications given in the manufacturer's technical sheet and/or in the certificate of conformity. The conformity sticker mentions the name of the certifying body, the control method, the fire resistance classification (according to the old national classifications or the harmonised European classification), the certificate number and any maintenance checks.

Any alterations made to the doors must scrupulously comply with the directives established in the technical manual accompanying the inspection certificate. These explain what is possible and what is not in terms of milling cylinder holes, replacing the lock box, adding reinforcing plates, drilling the leaf or the frame, replacement of handles and hinges, or even alterations

*The inspection certificate and technical notices are generally available from the manufacturer or the certification body (see their website). The validity period can be extended by the producer. Doors installed during the certificate's period of validity are therefore presumed to conform provided that the installation scrupulously respects the directives in the technical manual. If the certificate is no longer valid, it does not necessarily mean that the fire resistance performance of the door is no longer valid, but rather that the manufacturer has stopped producing this type of door and has not renewed the certificate. In the case of large batches, it may be useful to contact a certified inspection body to judge the advisability of recertification. In all cases, it is advisable to seek the advice of the competent authorities in case of doubt about the fire safety of buildings.*

to the dimensions of the leaf or the frame, etc. If the leaf must be slightly planed (in order to adjust its positioning in the frame or following the installation of a new floor covering, for example), it is essential that the intumescent bands of the internal structure are not revealed following removal of material.

Particular attention must also be paid to possible water damage. The presence of signs such as damp spots, flatness defects or even damage to the lower edge of the leaf can generally indicate a deterioration of the intumescent products contained in the leaf. Visible intumescent bands can also be checked visually.

2. *Equipment evaluation by an approved installer.* The latter can refit the element (s) according to the required instructions. The installer can also order the framing elements and the hardware necessary for a compliant restoration (see application and installation).

3. *Re-certification.* A re-installed door can also be certified again or in a complementary manner by an approved inspection body before it is put back into service, at the request of one of the parties concerned (builder, architect, contractor, installer, insurer).



**Applications and installation**

**It is generally easier to install a reclaimed leaf (and its hardware) in a new frame and with new hinges. Manufacturers of fire door sets are generally able to supply the elements necessary for a compliant refurbishment. The technical notices that accompany the original inspection certificate provide information on other installation possibilities and application details: compatibility with products from another manufacturer, construction of a custom frame according to the requirements described, compatibility of locks and hinges.**

It is strongly recommended that the door be installed by a certified installer who can also provide a placement report and affix a compliance label to the placed product.

In this respect, the re-installation of reclaimed fire doors does not differ from that of new fire doors. It raises the same points of attention and must comply with the manufacturer's instructions, the technical notices accompanying the original inspection certificate, the rules of the art in force and the installation standards. These relate in particular to compliance of the following aspects:

- dimensions of the door (leaf, frame, rabbet, etc.);
- accessories (locks, hinges, locking system, etc.);
- materials (density of wood for the manufacture of custom frames, type and rigidity of the floor covering, etc.);
- making of custom frames;
- tightness between the frame and the structural works (type of insulation, thickness, etc.);
- adjustment of the system (play, distance from the ground, flatness, floor covering, etc.);
- operation in case of fire (operation of the automatic closing system);
- presence and position of the certification sticker (+ maintenance sticker);
- etc.

In order to guarantee the performance of the door unit and its correct operation throughout its lifetime, it is necessary to provide for regular maintenance: cleaning, lubrication of the hardware, replacement of worn parts or missing elements, adjustment of the clearance between the leaf and frame, visual inspection of intumescent bands, minor damage repairs, moisture damage inspection, etc.

*Fire doors can also be used as "classic" doors (i.e. not subject to fire resistance requirements). In this case, slight deterioration, alterations or changes in dimensions are of less importance. It is then recommended to remove the certification stickers to prevent the door from being re-installed as a fire door.*



Example 1. Before reclamation



Example 1. After reclamation



Example 2. Before reclamation



Example 2. After reclamation



**Availability**

Fire doors are currently an uncommon product and in little demand on the reclamation market. The physical offer is mainly found with specialised dealers (or demolition contractors) active in urban areas. The available batches are often less than 10 similar pieces. Most of the time, only the leaves and some hardware items are available.

However, it is possible to obtain larger batches during the scheduled release of materials from the demolition/renovation of large buildings. Getting in touch with the companies involved can then lead to the potential reclamation of batches of tens or even hundreds of fire doors.

**Indicative prices (Excl. tax)**

Random sampling of the reclamation market in Western Europe (Belgium, France, Great Britain and the Netherlands) made it possible to extract some indicative prices. These vary very little depending on the model. They are around 50 to 70 €/unit excluding VAT for intact fire door leaves.

For information, the total budget devoted to the installation of a new standard fire door type EI1 60 is often between 600 and 1,300 €.

**Hazardous substances and precautions**



Old fire doors (before 1997) are likely to contain *asbestos*.



**Find specialised businesses**



[salvoweb.com](http://salvoweb.com)

[opalis.eu](http://opalis.eu)

**Embodied carbon (Cradle to gate - production A1-A3)**

kg CO<sub>2</sub> eq./FU

INIES database (FR) - MALERBA - Individual declaration - Fire resistant wooden door on wooden frame *	44.4
INIES database (FR) - MALERBA - Individual declaration - Fire resistant wooden door on metal frame *	18.6
ASSA ABLOY - Individual declaration - Fire resistant steel door on metal frame *	40.9

\* FU (Functional Unit) = square meter of opening area before installation



Reusing 1 m<sup>2</sup> of standard fire door unit (overall size) prevents the production of ~ 19 to ~ 44 kg of CO<sub>2</sub> equivalent related to the manufacture of a new fire door unit (production phase only). According to sources, this corresponds to the emissions of a trip of ~ 112 to ~ 266 km in a small diesel car.

Warning: these figures should be revised downwards if only the leaf is reclaimed.



**Disclaimer**

This sheet is intended for designers, specifiers and other members of construction project teams wishing to reuse this building material or product. It is part of a collection of sheets aimed at bringing together the available information to date that is likely to facilitate the reuse of building materials and products.

This sheet has been produced by Rotor vzw/asbl within the framework of the Interreg FCRBE project - Facilitating the Circulation of Reclaimed Building Elements, supported by the entire project partnership. Sources of information include the experience of reclamation dealers and involved project partners, lessons learned from exemplary projects, available technical documentation, etc.

The sheets have been produced between 2019 and 2021. As the reclamation sector is evolving, some information, notably regarding pricing and availability, may change over the time. When the text refers to European standards, it is up to the project team to refer, if necessary, to their national implementations and local specificities.

It is important to note that the information presented here is not exhaustive or intended to replace the expertise of professionals. Specific questions are always project related and should be treated as such.

The complete collection of sheets (including the introductory sheet) is freely available from different reference websites (a.o. [opalis.eu](http://opalis.eu), [nweurope.eu/fcrbe](http://nweurope.eu/fcrbe), [futureuse.co.uk](http://futureuse.co.uk)).

Non-exhaustive directories of dealers in reclaimed building materials are available on [www.opalis.eu](http://www.opalis.eu) and [www.salvoweb.com](http://www.salvoweb.com).

---

Interreg FCRBE partnership: Bellastock (FR), the Belgian Building Research Institute / BBRI (BE), Brussels Environment (BE), the Scientific and Technical Center of Building / CSTB (FR), Confederation of Construction (BE), Rotor (BE), Salvo (UK) and University of Brighton (UK).

The information contained in this document does not necessarily reflect the position of all the FCRBE project partners nor that of the funding authorities.

Unless explicitly stated otherwise, the content of these sheets is credited in the Creative Commons Attribution NonCommercial – Share Alike format (CCBY-NC-SA).



Unless explicitly stated, the images used in this document belong to © Rotor vzw/asbl or © Opalis. Any other image has been the subject of a systematic request for authorisation from their authors or rightful owners. When this request has not been answered, we assumed that there were no objections to the use of the image. If you feel that this interpretation is unreasonable, please let us know.



**Product description**

Having appeared more than 500 years ago, panelled wooden doors, also known as "joinery doors" or "traditional doors", have had many variations over time and are still commonly produced today. They are frequently found on the reclamation market, with a very wide variety of shapes, styles and also of constituent materials (solid wood, semi-solid, plywood, laminate or glued laminated timber, etc.). One of the most common models are single swing doors. The woods most frequently used are oak, ash, pine and other conifers, meranti, walnut, and to a lesser extent exotic woods.

This sheet deals with so-called interior "communicating" doors, that is to say without any particular technical characteristics of fire resistance, thermal insulation, sound insulation, burglary resistance nor stability. They are placed between two living quarters which do not have major climatological differences (temperature and atmospheric humidity). This sheet therefore does not apply to exterior doors, landing doors or cellar doors.

In general, a ready-to-use interior door unit consists of:

→ *One or two leaves*, also called "door leaves": this is the moving part of the door. These consist of an assembly of uprights and crosspieces (often solid wood or glued laminated wood) and infill elements (often based on solid wood, plywood, particle board or glass panels. ). Non-solid elements are usually covered with a sheet of natural wood veneer. The panels of a leaf are generally not secured to the uprights and crosspieces, so that when the wood is working, the panels do not crack. The leaf is generally fitted with a series of accessories such as handles, split hinges or hinges, locks, etc. The number of panels, the shape of the mouldings and the details of the joinery are often characteristic of a style or an era.

→ *A fixed frame*, also called "Dormant frame" or "door frame". This usually consists of different pieces fixed around the opening. It serves as a finish around the opening and allows the leaf to be adjusted as closely as possible to the opening. Depending on the model, it can be fitted with a fanlight or a fixed glazing element.

1. Flush
2. Rebate or flap
3. Joint cover (doorframe)
4. Hinge or hinge plate
5. Imposte

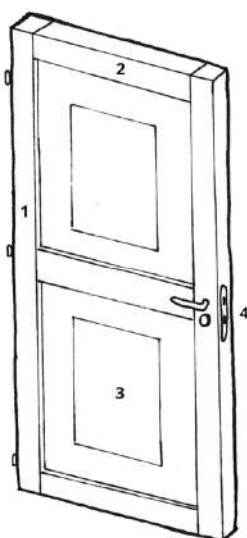

1. Uprights
2. Crosspieces
3. Panels
4. Hardware

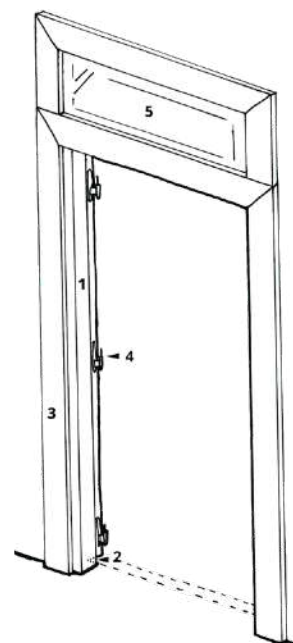

Anatomy of a panelled wooden door leaf

Anatomy of a door frame



Door with 8 panels, of which 6 glazed, painted



Door with 2 solid straight panels, unfinished



Door with 3 panels, 1 of which is glazed, curved style, varnished



Door with 3 solid straight panels, painted

**Product reclamation**

**Interior panel doors are mainly found in residential buildings but also in old school buildings, convents, dispensaries, etc.**

Most of the time, the reclamation of the door leaves is relatively easy. Careful disassembly of the frames can be more difficult. These depend essentially on the original installation and the nature of the materials constituting the frame. Typically, more recent recomposed woods are more difficult to carefully dismantle than older solid wood components. Frames are also more vulnerable to damage that may occur during transport and storage. In practice, frames are often only recovered when they are of particular interest due to their age, style, character, material composition or even their close consistency with the corresponding leaves (for example, if they have a very specific shape or dimensions).

Interior doors lend themselves well to on site reclamation. They may also be of interest to specialised suppliers active in the reclamation market. Typical steps in a reclamation process are as follows:

→ **Potential assessment.** An "expert eye" generally makes it possible to estimate the potential for reclamation during an on-site visit or based on photos and technical information relating to the manufacturer (for more recent doors), to the model, to the dimensions, to the presumed quantity. The focal points will be among others:

- The general condition of the batch. Are the elements in good condition (leaves, frame, lock, hardware, etc.)? Are there any traces of fungi, xylophagous insects or swelling due to excess moisture? Is the framework recoverable? Have the leaves been modified? Can they be restored or resized? Is there a risk of the presence of dangerous substances (old lead paints)? etc.
- commercial interest depending on model, quantity, possible repairs, resale potential, etc.
- Logistical arrangements, such as deadlines, handling constraints, transport, etc.

→ **Removal.** Careful dismantling must aim to ensure the perfect integrity of the elements (either of the door unit as a whole, or only of the leaf and its accessories). Each element of the same door unit will be correctly listed. Once taken down, it is advisable to remove

the split hinges or hinges, handles, locks, etc. to minimise the risk of deterioration during handling and storage. The parts will be sorted by models, qualities and dimensions. The framing elements can be removed carefully using wood chisels. Recomposed wooden frames are difficult to recover. Particular attention will need to be paid to the glazing elements. It is advisable to carefully store the handles and locks, even if they are defective, in order to be able to find the corresponding model, if necessary.

→ **Inventory.** In order to facilitate the design and installation work, it is advisable to take the measurements of each separate element at the time of removal, and to assign specific numbers to all the elements of the same door unit. It is recommended to list the opening direction of each door. Be careful, even a batch made up of a consistent series of identical doors may have dimensional variations due to alterations made during their use (planing of a door when laying a new floor in a room, for example).

→ **Storage.** The leaves are preferably stored on their edge in suitable racks, using suitable protections (foam strips, foam corners, intermediate sheets, etc.). If they are stored on their long side, it is better to orient the lock upwards. At most professional suppliers, the doors are stored vertically, on wooden blocks. To avoid the risk of deformation or breakage of the glazed elements, it is not recommended to store flat. The frame components and the hardware are stored in separate packages. The elements are ideally stored away from frost, at room temperature (15° C to 25° C), away from humidity and dust (recommended relative air humidity from 40 to 65%). As long as the storage conditions are observed, reclaimed wood doors have excellent dimensional stability.

→ **Operations.** Depending on their condition, the door elements may go through several operations before being put back into operation. Most suppliers specialising in reclaimed doors are able to perform these operations - and some suppliers offer them automatically when the doors are sold. However, sometimes the wood is salvaged or sold in its original condition. It is then up to the buyer to anticipate these stages. In this case, it is important to obtain clear information from the seller, especially on the door's material. For example, semi-solid wood doors look like a solid wood door but do not stand up to all restoration operations as well.



Vertical Storage

- **Surface treatment.** In many cases, the doors do not require any specific treatment, other than a superficial cleaning or any localized touch-ups. However, it may be that the new application requires removing the old top-coat present on the wooden elements (varnish, paint, stain, etc.). This can be done by sanding, scraping, sandblasting, heat or chemical stripping. These techniques require know-how and can damage the material considerably if done by unskilled people. In addition, special precautions must be taken to limit the associated risks, such as toxic fumes from chemical stripping or the toxicity of old lead paints. Several specialised workshops, working regularly with suppliers of antique doors, offer a chemical stripping service by soaking in a caustic soda bath. The reconstituted wood door elements (chipboard, plywood, etc.) do not withstand this operation.





The application of a new topcoat is possible in the workshop or during re-installation: preservative, varnish, stain, paint, etc. A specific curative treatment should be considered if there are xylophagous insects or fungi. These products will be chosen with regard to the desired aesthetics, their environmental impact and their influence on indoor air quality.

- **Carpentry services.** Many specialist dealers have a carpentry workshop and are able to perform operations such as adjusting or resizing the size of the leaves, reworking cross members, replacing damaged panels, surface repairs, manufacturing a new frame, altering the opening direction, fitting a rebate seal, degreasing the edges, milling the hinge and lock locations, drilling the striker hole, etc. Such operations can also be entrusted to a traditional carpenter. These operations are not necessarily suitable for recomposed wood elements.

- **Replacement of hardware.** Replacing hardware items is not always easy. It is relatively easy to replace missing hinges, provided the load specifications are respected (maximum weight per unit, door width, number of components per door). On the other hand, it is more complicated to replace the original handles and locks which have disappeared, or which prove to be unusable. Some specialist dealers are however able to carry out the repair using original parts or copies of old models. The price will depend in particular on the quality of the fittings and the used. It is therefore strongly recommended to keep the defective elements to facilitate their replacement.

→ **Transport and delivery.** All necessary precautions must be taken in order to limit the deterioration of the elements: dividers, protections of the corners and edges, strapping of the parts, etc.

It is advisable to involve specialised professionals to ensure the smooth running of these operations.

Most of the reclaimed building products are sold as is. The conditions of sale may however contain special guarantees specific to the product. In certain cases, an installation service with a ten-year guarantee can accompany the product. Some suppliers are able to indicate the origin of the material and/or provide documentation on the product purchased (*for more information, see the introductory sheet*).



*Chemical soaking plant*



*The sanding of the wooden elements widens the grooves in wood*



*Panel door stripped and sanded*



*Replacement of glazing elements*



*Cracked full panel*

#### **Fixing devices**

*In the event that new hinges, split hinges or pins have to be fitted, these should be chosen with regard to the weight of the door. Otherwise, the door may fall or jam. For more information, it is advisable to refer to the specifications of the hardware supplier.*



*Resizing*



## Applications and installation

**Interior doors with reclaimed wood panels can be used as communicating doors in residential buildings where they are subjected to moderate loads, characterised by a low thermal and hygroscopic gradient between rooms, little or no specific acoustic requirements, non-industrial applications, etc. Some reclaimed doors may also be suitable for more demanding uses. They must then specifically demonstrate their suitability for use.**

In all cases, the doors must be compatible with the use of the room where they are installed (see § "Characteristics and fitness for use"). In all cases, reference should be made to the use standards, to the state of the art in force and installation standards.

During the design phase, the reclamation of doors frequently raises the question of dimensions. It is indeed a question of ensuring the correspondence between the dimensions of the openings and those of the doors. Several scenarios are encountered:

- Either the door is pre-existing to the design of the opening. This is the case, for example, where doors have been dismantled in an old building to be used in a new project, still in the design phase. The designer can then rely on the inventory of available doors to customise the new openings.
- Either the opening is pre-existing to the choice of the door. This is the case, for example, of the renovation of an existing building where installation of reclaimed doors is required. In this case, it is a question of finding doors whose dimensions correspond to those of the openings. Specialised suppliers usually have a considerable stock and, most of the time, it is possible to find what you are looking for.

It should be noted that the installation still leaves a certain room for manoeuvre since it is generally possible to adjust the dimensions by adapting the frame somewhat, by slightly planing the leaf or even by completely resizing the door (for as far as the model allows). In any case, these operations benefit from being done well in advance. A detailed inventory showing the respective dimensions of the openings and leaves can greatly facilitate *match-making*.

When the original framing is reused, it often needs to be shortened to accommodate the wall thickness of the new opening (often thinner than an older wall).

When the original frame has not been recovered, it will be necessary to provide a new one. This must be designed taking into account the character of the reclaimed leaf to avoid a break in style in terms of the type of wood, the nature of the finishes, the patina, etc. (unless this break is precisely the desired effect).

When entrusted to a qualified person, the re-installation of reclaimed doors does not differ from that of new doors. It raises the same points of attention:

- dimensions of the door (leaf, frame, rebate, accessibility for people with reduced mobility, etc.);
- required performance (mechanical, dimensional stability, brightness, passage of air under the door, etc.)
- model (one or two leaves, straight edge, overlapping, left opening, right opening, etc.)
- materials (type of wood, wall support, flooring, etc.);
- accessories (locks, hinges, split hinges or pins, handles, rosettes, door stopper, etc.);
- fitting the frames, dimensional tolerances (plumb, squaring, level, etc.), fixing means, support, type of door frame (traditional, renovation, end of site installation, jamb/counter-jamb), etc.;
- adjustment of the system (squareness, level, plumb, play, distance from the ground, floor covering, etc.);
- finish (veneer, varnish, paint, stain, preservative, etc.).

Each door requires an individualized approach. Old doors of the same series can sometimes have more or less pronounced differences.

After ensuring that the doors have been stored in a controlled environment (to ensure that the humidity of the wood is between 8 and 12%), it is recommended that the doors are acclimatised to their new environment by allowing them to rest for 24 hours in the space where they will be installed (more if possible). This is to prevent any deformations occurring when they are already in place.

Good maintenance is essential for the proper functioning and keeping the performance of the door unit throughout its life: cleaning, lubrication of hardware, replacement of worn parts or missing elements, adjustment of the clearance between the leaf and the door frame, minor damage repairs, moisture damage inspection, etc.



Adaptation or replacement of hardware



Reclaimed hardware items

### Design tip!

*To increase the chances of meeting the offer available on the reclamation market, the specifier can choose to accept doors of different models, as long as they meet the required criteria (dimensions, presence of glazed elements, same type of door). wood, etc.).*

*Warning! Old doors do not necessarily have the same dimensions as newer standard doors. This should be taken into account during design and construction.*



### Characteristics and fitness for use

The performance expected from interior doors depends on the intended application. This is generally defined by:

- the type of building in which the door is installed: residential, non-residential, public buildings, schools, etc.
- the nature of the rooms to be separated: bathroom, kitchen, classroom, boiler room, etc.
- the nature of the door movement: hinged, pivoting, sliding, etc.

In general, doors without special features must have the basic performance that all doors for non-industrial applications must meet. On a European level, a product standard relating to determining the performance characteristics of interior pedestrian door units is currently the subject of a draft harmonised European standard (prEN 14351-2). Currently, these minimum requirements are governed by national application standards and specifications.

It is not easy to assess the conformity of reclaimed panel doors with these requirements. The relevant characteristics to consider are discussed in the table below. In most cases, however, it can be assumed that reclaimed doors retain their mechanical properties, provided that careful removal has been carried out and contact with a damp environment has been avoided. It is often not economically justified to carry out performance tests, either because the quantity of similar doors to be used is too small, or because the doors have unique characteristics which must be evaluated case by case.

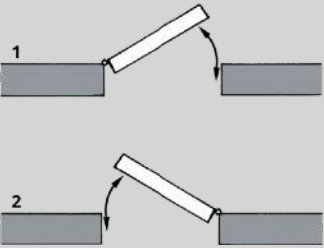
Characteristics	Comments
<p><b>Opening direction</b></p>	<p>The opening direction of the doors should be clearly defined. The EN 12519 standard defines the opening direction as the closing direction, while most new door manufacturers determine it in the opening direction.</p> <p>Ex :</p>  <p>1) left opening; 2) right opening</p>
<p><b>Dimensional tolerance</b></p>	<p>Wooden doors tend to expand or contract with fluctuations in temperature and humidity. Throughout their working life, reclaimed doors have been subject to conditions that are specific to them and which are not necessarily known. Some deformations are reversible while others are definitely noticeable. Irreversible deformations can be assessed by means of a detailed visual inspection (curvature, flatness, etc.) of the door under normal climatic conditions. In some cases, they can be corrected in the workshop, otherwise they will have to be discarded. It is also advisable to find out about the storage conditions and to acclimatise the doors to their new environment for a minimum of 24 hours before installation (<u>several days if possible!</u>).</p> <p>Regarding the nominal dimensions given by the seller (height, width, thickness, squareness), a maximum deviation of ± 1.5 (thickness) to 2.0 mm (height and width) is commonly accepted at the time of receipt (tolerance class 1). The EN 1529 standard defines these specifications.</p>
<p><b>Shape stability, flatness, moisture resistance</b></p>	<p>These characteristics are difficult to assess. They define the degree of deformation (twisting, curvature, warping etc.) of the doors when they are subjected to variations or temperature and humidity gradients without this affecting their operation. In order to overcome this uncertainty, it is advisable to use reclaimed panel doors in interior applications with low stress. It is also advisable to acclimatise the doors to their final environment at least 24 hours before installation (<u>several days if possible!</u>).</p> <p>In damp rooms (bathroom, kitchen, toilet, laundry room, etc.), the opening under the door must be sufficient to allow good air circulation. It is also possible to install a ventilation grid provided for this purpose.</p>
<p><b>Frequency of use</b></p>	<p>An interior door must open and close perfectly throughout its life. Normal use should not alter its appearance or function. The involvement of a professional or a craftsman generally makes this performance more reliable.</p>





Characteristics	Comments
<b>Mechanical resistance</b>	<p>Mechanical strength is the ability of a door to withstand unforeseen loads such as kicking or forcing. Although a series of tests makes it possible to assess this performance in the case of new doors (for example: vertical angular load test with open door [NBN EN 947], static torque with open door [NBN EN 948], shocks with a soft and heavy body when the door is closed [NBN EN 949], shocks when the door is closed [NBN EN 950]), it is difficult to envisage applying them to reclaimed doors.</p> <p>However, the experience of a professional or a craftsman generally makes it possible to ensure the overall reliability of a door, with regard to the specific features of the leaf and the frame (weight, thickness and type of wood, and wall thickness, etc.) and the load capacity of the fasteners (hinges, split hinges, etc.).</p>

Regarding the design of new frames for the re-use of reclaimed door leaves, it is recommended to comply with European standard EN 942 which describes the general requirements relating to wood in joinery and with standard EN 14221 which defines the requirements and specifications applicable to wood and wood-based materials in the leaves and frames of interior doors. Specific standards also deal with butted, glued, laminated or recomposed timber.



Reuse of panelled wooden doors © Cyrus Cornut, Grande Halle de Colombelles, WIP. Architects: Encore Heureux (FR)



Reuse of panelled wooden door © Sophie Boone (BE)



**Availability**

Although there are many types and designs, wood panelled doors are a very common product in the reclamation market. Availability depends on the quantities sought, but it is quite possible to obtain relatively large batches of identical doors.

Frequent	Batch of 1 pièce
Occasional	Batch of 2 to 10 identical pieces
Rare	Batch of > 10 identical pieces

*Straight edge or overlapping door*

Reclaimed panel door models vary greatly by country. In Belgium and France, for example, the current models are "straight edge" while in the Netherlands and Germany, overlapping models are more common.

**Find specialised businesses**



salvoweb.com

[salvoweb.com](http://salvoweb.com)



opalis.eu

[opalis.eu](http://opalis.eu)

**Indicative prices (Excl. tax)**

Random sampling of the reclamation market in Western Europe (Belgium, France, Great Britain and the Netherlands) made it possible to extract some indicative prices. These vary greatly depending on the models, dimensions, type of wood, finish and suppliers. Oak doors are the most expensive, but pine and pitch pine are also in demand.

- Supply price:
  - Single door leaf not stripped: ~30 €/piece
  - Stripped single door leaf: ~60 €/piece
  - Door leaf from the beginning of the 20th century not stripped: 100 to 200 €/piece
- Resizing: 50 to 150 €/piece depending on the complexity
- Chemical stripping in bath: 50 to 80 €/piece

However, the replacement of missing or defective hardware parts should also be budgeted for.

Even taking into account these operations specific to reclamation logics, reclaimed wooden panel doors are generally a cheap alternative to new products.



Illustrated manual for dismantling doors and accessories for reclamation (in French): <http://reuse.brussels/pdf/deuren-en-toebehoren.pdf>

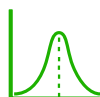

Assessing the impact of reclaimed timber construction products on global warming is complex and difficult to generalise. The general principle is that construction timber can confine biogenic carbon. Reclamation is therefore a way of preserving these carbon stocks and preventing it from being released into the atmosphere (which would be the case if the wood was incinerated, for example). The overall environmental assessment of a reclaimed wooden element must, however, also take into account aspects such as the origin of the product, the distance travelled, etc. For more information, it is advisable to consult the specific paragraph devoted to this question in the introductory sheet.

**Hazardous substances and precautions**



A *lead* diagnosis may be necessary to detect the presence of old lead paints on leaves and frames. This diagnosis can be carried out either using a commercially available lead test kit, or by sending a sample of the paint to a laboratory or by having this test carried out by a professional. In this case, it is strongly recommended to strip and/or repaint using a specialised operator. It is strongly advised against using a heat gun, sander or sandpaper to remove lead paint. Chemical stripping will be preferred, with adequate health and environmental provisions.



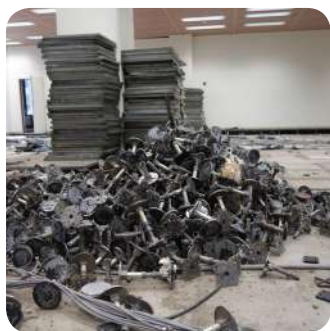

# INTERIOR FINISHINGS



- Ceramic wall tiles
- Cement based tiles
- Unglazed terracotta tiles
- Unglazed porcelain tiles
- Solid wood floors
- Raised access floor
- Carpet tiles
- Natural stone flooring slab
- Natural stone shelf





**Disclaimer**

This sheet is intended for designers, specifiers and other members of construction project teams wishing to reuse this building material or product. It is part of a collection of sheets aimed at bringing together the available information to date that is likely to facilitate the reuse of building materials and products.

This sheet has been produced by Rotor vzw/asbl within the framework of the Interreg FCRBE project - Facilitating the Circulation of Reclaimed Building Elements, supported by the entire project partnership. Sources of information include the experience of reclamation dealers and involved project partners, lessons learned from exemplary projects, available technical documentation, etc.

The sheets have been produced between 2019 and 2021. As the reclamation sector is evolving, some information, notably regarding pricing and availability, may change over the time. When the text refers to European standards, it is up to the project team to refer, if necessary, to their national implementations and local specificities.

It is important to note that the information presented here is not exhaustive or intended to replace the expertise of professionals. Specific questions are always project related and should be treated as such.

The complete collection of sheets (including the introductory sheet) is freely available from different reference websites (a.o. [opalis.eu](http://opalis.eu), [nweurope.eu/fcrbe](http://nweurope.eu/fcrbe), [futureuse.co.uk](http://futureuse.co.uk)).

Non-exhaustive directories of dealers in reclaimed building materials are available on [www.opalis.eu](http://www.opalis.eu) and [www.salvoweb.com](http://www.salvoweb.com).

---

Interreg FCRBE partnership: Bellastock (FR), the Belgian Building Research Institute / BBRI (BE), Brussels Environment (BE), the Scientific and Technical Center of Building / CSTB (FR), Confederation of Construction (BE), Rotor (BE), Salvo (UK) and University of Brighton (UK).

The information contained in this document does not necessarily reflect the position of all the FCRBE project partners nor that of the funding authorities.

Unless explicitly stated otherwise, the content of these sheets is credited in the Creative Commons Attribution NonCommercial – Share Alike format (CCBY-NC-SA).



Unless explicitly stated, the images used in this document belong to © Rotor vzw/asbl or © Opalis. Any other image has been the subject of a systematic request for authorisation from their authors or rightful owners. When this request has not been answered, we assumed that there were no objections to the use of the image. If you feel that this interpretation is unreasonable, please let us know.



**Material Description**

Earthenware tiles can be recognised by their glazed surface. They are made from a biscuit (fired and unglazed ceramics) consisting of a paste of clay, quartz and limestone, whitish, earthy or tinted in colour, fired between 1000 °C and 1200 °C, then covered with a colourless or tinted glaze, plain or patterned, hardened in the kiln at around 1050 °C (double firing). The earthenware biscuit is generally very permeable (porosity  $E_b > 10\%$ ) while the glaze provides a layer of protection against wear and makes the glazed face less permeable to liquids.

This material, produced for centuries, has seen its use spread considerably during the 20th century. A famous example is the 'metro' tile covering the Paris underground stations, and whose tile pattern is still reproduced today. This material is generally used as an interior wall covering, in particular in sanitary facilities, in private, public and community buildings. They can be confused with their counterparts in glazed stoneware or glazed porcelain stoneware, which are stronger, less porous and more resistant to shocks and temperature variations.

The reuse of this product is possible but strongly depends on the state of the glaze layer. If this is altered, the product will lose many of its interesting properties and will see its new uses severely limited. Moreover, their dismantling is often delicate. This material is therefore rarely found in large quantities on

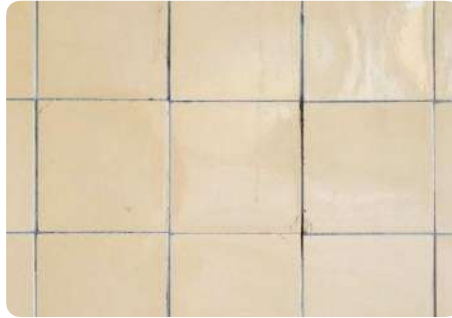

→ **Formats:** there are many formats but generally square and rectangular. Their nominal dimensions are generally in the order of 10 × 10 cm, 15 × 15 cm, 20 × 20 cm and 10 × 20 cm, 7.5 × 15 cm ('metro' tiles). Smaller frieze elements are sometimes present. The thickness is variable according to the models and generally between 5 and 7 mm.

→ **Finish:** visible matte or glossy glazed surface. The finishing of the tile edges can take on various forms: straight edges (glazed or unglazed), chamfered or rounded edges on one side (edge tiles), rounded on two edges (corner tiles).

→ **Texture:** mostly smooth and uniform for the upper surface (visible). The edges can be partly covered with glaze. Some models or frieze elements may also have a relief on the upper surface. The underside (not visible) is generally provided with a slight relief to improve adhesion to the substrate. In many cases, the manufacturer's name is on the underside.

→ **Colours:** the colours vary, generally a solid colour or with decorative patterns. Colours are often brighter than their porcelain stoneware counterparts. When the glaze wears off, the biscuit appears white or earthy in colour.

the reclamation market. On the other hand, there are smaller, much more stable batches of patterned tiles painted by hand and/or which have a high heritage value (e.g. Delft tiles).





**Material reclamation**

The wall tiles are regularly found in existing buildings. Although their dismantling is delicate, these tiles can represent a great opportunity for reuse, either on-site or through the professional channels of material resellers.

→ *Dismantling tests*: dismantling tests make it possible to verify the feasibility and profitability of the removal. The type of laying (cement/lime mortar, adhesive mortar, adhesive) and the characteristics of the joints (thickness, composition) strongly affect the possibility of cleanly dismantling the material.

→ *Removal*: careful dismantling should aim to ensure the integrity of the tiles and a certain uniformity of the batches. To minimise the risk of deterioration during dismantling, it is advisable to weaken the tensions within the tiles by first freeing 2 sides (perpendicular) of the tiles to be detached. This usually involves breaking non-free edge lines. The tiles will be sorted by quality, colour, size and degree of cleaning. They will be stored on their edge, thereby avoiding the risk of scratching the glaze. 'Face to face' storage will be preferred.

→ *Treatment*: the main treatment offered by the suppliers of reclaimed earthenware tiles is the mechanical cleaning of the remains of mortar on the underside and on the edges. This manual step is generally performed using a sharp tool and requires systematic downstream sorting. Tiles with signs of chips, dents in the glaze and/or cracks are downgraded. Tiles with adhesive residue are often sold as is, which implies special arrangements at the time of laying (*it is recommended to seek advice from a professional tiler*).

→ *Storage*: tiles are stored in bulk on pallets, in boxes or reconditioned in bundles, taking the necessary precautions to prevent wear of the glaze. The tiles must be stored away from frost and bad weather.

→ *Transport and delivery*: the necessary precautions must be taken during transport and delivery in order to minimise breakage (strapped, shrink wrapped pallet, etc.). It should be noted that the pre-packaged tiles facilitate laying.

It is advisable to involve specialised professionals to ensure the smooth running of these operations



Tile removal



Removed tiles



Packed reconditioned tiles

**Think reversible!**

The use of a hybrid mortar (lime-cement) and cement-based joints without resin facilitates future dismantling. These traditional laying methods, not referenced in the current harmonised European standards, may however have lower adhesion performance and should be reserved for substrates having a very high dimensional stability.



*Crazing or crackling* is a set of hairline cracks affecting the glaze layer of a tile. This phenomenon is generated by tension between the glaze and the biscuit at the time of its manufacture (desired decorative effect) or abnormally, after laying through tension applied to the tiles (for example: structural constraints, swelling biscuit due to excessive humidity, differentiated expansion, unsuitable laying technique and/or substrate, etc.). This results in a network of cracks within the glaze layer, which is a privileged passageway for water and liquid substances towards the biscuit. It is therefore important to provide for the application of an additional water-repellent protective layer if the use of the tiles involves the presence of liquid and potentially staining substances (kitchens, bathrooms, etc.).



**Applications and laying**

Glazed earthenware ceramic tiles are recommended for interior wall applications, in dry or low humidity spaces (i.e. possible humidification by spraying water at low pressure and maximum air temperature of 40°C). These are spaces and rooms for private use, individual and community shower rooms (but without hydro-therapeutic massage facilities) and sanitary facilities for moderate or frequent (collective) use. Despite its surface glaze layer, the wall tiles (tiles + joints) should not be considered as completely waterproof.

Due to their relative porosity and fragility, *outdoor use is not recommended*. They are also not recommended for more intensive applications such as community kitchens, façades, food production premises, laboratories, cold rooms, etc. In the case of uses involving staining and/or aggressive products, it is advisable to check the condition of the surface glaze layer. If necessary, a suitable water repellent surface treatment can be applied.

The choice of tiles must necessarily take into account the expected stresses (see § 'characteristics and fitness for use'). In all cases, reference should be made to the European and national standards relating to the product (EN 14411) and to the rules of practice in force (or implementation standards).

The reuse of completely cleaned reclaimed tiles is no different from that of new tiles. They lend themselves to the same diversity of laying methods, patterns and fittings. They raise the same points of attention and requirements, in particular: properties and condition of the substrate, laying and jointing products, drying times and installation times, costs, expansion joints, finishing joints, sanitary sealing, accessories (friezes, connecting pieces and edge protection, underlying waterproofing), flatness, etc.

The use of tiles with rounded edges (rare on the reclamation market) or with straight, glazed edges is possible for projecting angles and visible edges. Otherwise, PVC or aluminium corner profiles should be used. If necessary, new elements can supplement a reclaimed batch.

Depending on the planned level of finish and the installation technique chosen, different tolerance classes can be considered for the substrate. Thus, the application of a traditional setting mortar will make it easier to conceal irregularities (due for example to the presence of residual mortar on the underside

of reclaimed tiles) than when the tiles are laid using an adhesive mortar or adhesive. For a thin bed laying, the tolerance classes of flatness, plumb and horizontality of the substrate must be respected and must, therefore, be equal to those required for tiling.

Keeping residual mortar on the edges should be avoided insofar as this risks affecting the nominal size of the joints as well as their colour and composition.

To facilitate *installation*, the designer/specifier will take care to use batches with a certain degree of uniformity in terms of the following characteristics:

- **Batch composition:** the batch must consist entirely of unglazed porcelain stoneware tiles.
- **Dimensions:** the dimensions of the tiles must be uniform, including their thickness. The dimensional tolerance is determined by the designer/specifier according to the equipment, the thickness of the joints and the laying technique.
- **Colour:** slight variations in colour are possible (even for new products). In the case of reclaimed tiles, these variations may be due to the original exposure. It is advisable to mix the tiles when laying. The designer can also opt expressly for a pattern including tiles of very different colours. This is one way to take advantage of a greater variety of reclaimed tiles that can lead to architecturally interesting results.

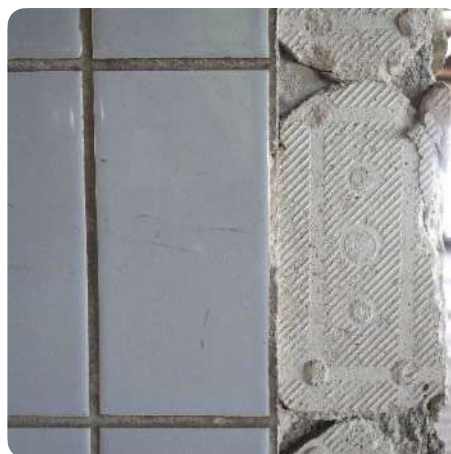

Wall tiles on hybrid mortar

- **Condition:** reclaimed wall tiles may show alterations such as signs of surface wear, chipped or cut edges, small holes, shards, manufacturing or firing cracks, the presence of crazing or peeling, which expose the biscuit to degradation. These alterations increase the risk of water penetra-

tion and cause the appearance of stains under the glaze. It is up to the designer/specifier to define the degree of imperfection tolerated, according to the defined use, by specifying the maximum dimensions of the defects (for example, crazing: accepted, breaks and chipping < 25 mm<sup>2</sup>). This principle can be described in visual form to facilitate the examination of the tiles. Example:

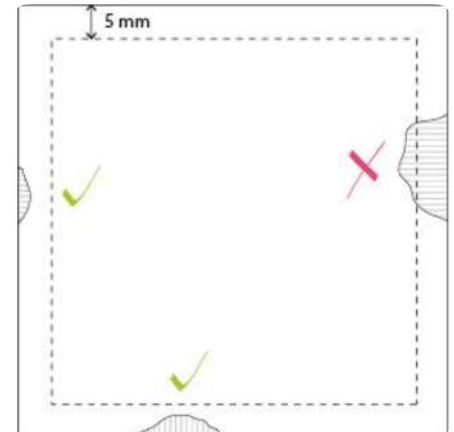

- **Quantity:** some suppliers can include a 5% surplus when the product is delivered if they are not able to guarantee the absolute uniformity of the characteristics mentioned above. This surplus can also be applied in the case of an on-site salvage scenario.

To facilitate installation, the designer/specifier will take care to use batches with a certain degree

Most professional suppliers are able to ensure that delivered batches meet these requirements

Most of the reclaimed building materials are sold as is. The conditions of sale may however contain specific guarantees specific to the material. Some suppliers are able to indicate the origin of the material and/or provide documentation on the product purchased (for more information, see the introductory sheet).



### Characteristics and fitness for use

The harmonised European standard EN 14411 establishes the relevant characteristics (depending on the context) in order to determine the fitness for use of ceramic tiles. Although detailed for new materials, these characteristics may prove useful in considering the specific case of reclaimed unglazed porcelain stoneware tiles.

In the event of specific and demanding applications, parameters related to characteristics such as wear resistance, resistance to stains or even water absorption must be measured and quantified using tests carried out by approved laboratories.

Characteristics	Comments
<b>Dimensions (length, width, thickness)</b>	This characteristic is closely related to the degree of sorting and cleaning of reclaimed tiles. A visual or detailed examination of the batch is often sufficient to estimate it.
<b>Geometry (straightness of edges, angularity, flatness of the surface)</b>	ditto
<b>Surface quality</b>	Careful examination of the glaze layer is necessary to ensure the presence/absence of crazing, knocks, chips and cracks.
<b>Slight colour differences</b>	For specific applications.
<b>Flexural strength or Modulus of rupture</b>	Mainly depending on the thickness and porosity of the tile. Relevant performance to be assessed in the event of high static and/or dynamic loads.
<b>Surface abrasion resistance</b>	For specific applications (industrial, commercial, etc.) where the risk of scratches, friction with trolleys, moving barrels, etc. is high.
<b>Shock resistance</b>	For specific applications (industrial, commercial, etc.) where the risk of impact with trolleys, moving barrels, etc. is high.
<b>Linear thermal expansion</b>	Low for most ceramic tiles.
<b>Resistance to low and high temperatures and thermal shock</b>	For specific applications where tiles are subjected to intense temperature values or gradients.
<b>Moisture expansion</b>	Low for most ceramic tiles.
<b>Impermeability to liquids likely to be projected onto the wall and water absorption</b>	A layer of glaze in good condition ensures a relatively good tile seal. However, given the high porosity of the biscuit, it is not recommended to use earthenware tiles in very humid places. Depending on the degree of exposure to water, care must also be taken to ensure that the underlying system is water-proof before laying the tiles.
<b>Resistance to crazing</b>	To be determined if the use of tiles implies the presence of liquid and potentially staining substances (kitchens, bathrooms, etc.).
<b>Adhesion to adhesive mortars, dispersion adhesives or reactive adhesives</b>	Depending on the type of laying recommended and performance classes of the products to be laid.
<b>Reaction to fire</b>	In accordance with European Commission Decision 96/603/EC, ceramic tile floor coverings are classified as non-combustible materials and belong to the European reaction to fire class A1 without prior testing.
<b>Release of hazardous substances (lead and cadmium)</b>	Only applicable for materials in contact with foodstuffs (see EC Regulation No. 1935/2004 and Directive 84/500/EEC).
<b>Resistance to low and high concentrations of acids and base products</b>	Reclaimed wall tiles are not recommended for intensive applications such as laboratories.
<b>Stain resistance</b>	A layer of glaze in good condition usually ensures a good resistance to stains. In the presence of crazing, it is best to provide for the application of an additional water-repellent protective layer to prevent stains.
<b>Suitability for cleaning and maintenance</b>	Depends on the cleaning product used, the water pressure and the surface texture of the tile (condition of the glaze layer).
<b>Ease of repair and adaptation</b>	To be determined with the professional in charge of laying.
<b>VOC emissions</b>	Volatile Organic Compounds are destroyed at the time of combustion of organic materials possibly present in clay raw materials. The original ceramic tiles are therefore considered to be free of VOCs. However, the laying and protection products can potentially emit VOCs.



**Embodied carbon (Cradle to gate – production A1-A3)**

	kg CO <sub>2</sub> eq./m <sup>2</sup>	kg CO <sub>2</sub> eq./kg
Mosa Wall Tiles – Individual declaration (Manufacturer data)	5.63	0.31
INIES database (FR) – Generic data	11.30 (*)	0.63
ICE database (UK)	17.94	0.78

Indicative values for an average thickness of 6 mm and estimated density of 1800 kg/m<sup>3</sup>, (\*) Including glue and joint



Reusing 100 m<sup>2</sup> of tiles prevents the production of ~ 1000 to ~ 1800 kg of CO<sub>2</sub> equivalent related to the manufacture of new tiles (production phase only). This corresponds to a journey of ~ 6000 to ~ 11500 km in a small diesel car.

**Availability**

Unglazed porcelain stoneware ceramic tiles are a relatively common product in the reclamation market. However, availability depends a lot on the quantities required. As an example :

Frequent	Batch from 1 to 5 m <sup>2</sup>
Occasional	Batch from 5 to 20 m <sup>2</sup>
Rare	Batch > 20 m <sup>2</sup>

**Indicative Prices (excl. tax)**

A non-exhaustive sample of the Western European reclaim market (Belgium, France, UK, and the Netherlands) has allowed us to extract some indicative prices:

→ Cost of removal: 15 - 25 €/m<sup>2</sup>

→ Cleaning service: 25 - 35 €/m<sup>2</sup>

Supply: depending on size, pattern, general condition, etc. (excluding antiques)

→ Cleaned tiles: 25 - 50 €/m<sup>2</sup>

**Hazardous substances and precautions**

**Heavy metals:** The components in the glaze covering reclaimed glazed earthenware tiles are likely to contain atoms of lead and cadmium. These heavy metals are toxic to the body and to the environment and can migrate in contact with food. In the absence of specific technical documentation, attention should be paid to tiles intended for use on worktops and wall surfaces where food is prepared. For more information, you are advised to refer to European Regulation EC No. 1935/2004 and Directive 84/500/EEC which set the recommended limits not to be exceeded. This requirement can be verified by accredited control bodies.

**Asbestos:** Some tile adhesives used before 1990 may contain asbestos. Even if the risk is low (< 1 to 10% depending on the application and the countries), adequate measures must be taken in order to make a correct diagnosis. The risk is slightly higher for adhesives used in skirting board applications.

**Find specialised businesses**



[salvoweb.com](http://salvoweb.com)

[opalis.eu](http://opalis.eu)

**Design tip**

To increase the chances of meeting the offer available on the reclamation market, the designer/specifier can choose to split large surface areas into smaller quantity batches (for example, by providing different patterns in each room).



Reclaimed wall tiles in a sanitary space (BE)  
© VLA Architectes

**Did you know?**

As an example, the market for new wall tiles in France is around 50 million m<sup>2</sup>/year (all types included).



**Disclaimer**

This sheet is intended for designers, specifiers and other members of construction project teams wishing to reuse this building material or product. It is part of a collection of sheets aimed at bringing together the available information to date that is likely to facilitate the reuse of building materials and products.

This sheet has been produced by Rotor vzw/asbl within the framework of the Interreg FCRBE project - Facilitating the Circulation of Reclaimed Building Elements, supported by the entire project partnership. Sources of information include the experience of reclamation dealers and involved project partners, lessons learned from exemplary projects, available technical documentation, etc.

The sheets have been produced between 2019 and 2021. As the reclamation sector is evolving, some information, notably regarding pricing and availability, may change over the time. When the text refers to European standards, it is up to the project team to refer, if necessary, to their national implementations and local specificities.

It is important to note that the information presented here is not exhaustive or intended to replace the expertise of professionals. Specific questions are always project related and should be treated as such.

The complete collection of sheets (including the introductory sheet) is freely available from different reference websites (a.o. [opalis.eu](http://opalis.eu), [nweurope.eu/fcrbe](http://nweurope.eu/fcrbe), [futureuse.co.uk](http://futureuse.co.uk)).

Non-exhaustive directories of dealers in reclaimed building materials are available on [www.opalis.eu](http://www.opalis.eu) and [www.salvoweb.com](http://www.salvoweb.com).

---

Interreg FCRBE partnership: Bellastock (FR), the Belgian Building Research Institute / BBRI (BE), Brussels Environment (BE), the Scientific and Technical Center of Building / CSTB (FR), Confederation of Construction (BE), Rotor (BE), Salvo (UK) and University of Brighton (UK).

The information contained in this document does not necessarily reflect the position of all the FCRBE project partners nor that of the funding authorities.

Unless explicitly stated otherwise, the content of these sheets is credited in the Creative Commons Attribution NonCommercial – Share Alike format (CCBY-NC-SA).



Unless explicitly stated, the images used in this document belong to © Rotor vzw/asbl or © Opalis. Any other image has been the subject of a systematic request for authorisation from their authors or rightful owners. When this request has not been answered, we assumed that there were no objections to the use of the image. If you feel that this interpretation is unreasonable, please let us know.



## Material Description

Cement-based tiles (hereafter referred to simply as 'tiles') are well suited for reclamation. They are strong and durable materials that are made from coloured cement and sand, moulded and shaped by pressing without firing. Some include stony aggregates incorporated into the mass or in the form of a surface wear layer. They owe their strength to the hardening of the cement. Their high mechanical resistance to compression, shocks and bending, as well as the possibility of ensuring satisfactory flatness thanks to narrow joints have favoured their use in functional buildings – in particular for equipment requiring the passage of machinery on casters. By their composition, they are on the other hand porous, frost-sensitive and sensitive to acids and stains (unless treated with a pore filler).



Produced in abundance in Europe since the end of the 19th century, cement tiles can be found quite easily from professional suppliers of reclaimed materials. They should not be confused with other types of tiles such as porcelain stoneware or resin-based re-composed stone tiles, both less porous and more resistant, or slip-based tiles ('encaustic tiles') very popular in the United Kingdom, or concrete slabs. An erroneous trade name sometimes refers to 'cement tiles' to actually designate tiles with traditional patterns.

There are two main types of cement tiles, depending on the composition of the visible layer:

### 1. Cement tiles

They can be:

- Single-layer: consisting of white or grey cement, stone powder and colouring pigments.
- Two-layer: composed of a wear layer (visible face) whose composition is similar to that of single-layer tiles, and an underlay (sole) based on sand, grey cement and fine gravel for strength. The wear layer is thin (approx. 4 mm) compared to the total thickness of the tile (> 15 mm).

### 2. Terrazzo tiles

They can be:

- Single-layer: composed of dust, grains and fragments of a suitable aggregate, coated with a paste of white or grey cement and colouring pigments.
- Two-layer: composed of a wear layer (visible face) whose composition is similar to that of single-layer tiles, and an underlay (sole) based on sand, grey cement and fine gravel for strength.



Two-layer 'cement' tile



Two-layer 'terrazzo' tile - Edge



Single-layer 'cement' tile - Front Side



Two-layer 'terrazzo' tile - Front side



Single-layer 'cement' tile - Back Side



Two-layer 'terrazzo' tile - Back side





## Cement based tile

The aggregates used in the manufacture of terrazzo tiles can constitute up to 80% of the finished product, and can be siliceous in nature (quartz, quartzite, granite, porphyry, sand, etc.), or limestone (marble, limestone, dolostone, etc.). The dimensions of the aggregates vary according to the desired rendering. The resistance of the wear layer strongly depends on the degree of hardness of the aggregate used. These aggregates are generally by-products of stone extraction, the glass industry or even ceramic tile fragments, which thereby find interesting outlets.



*Terrazzo tile whose aggregate is made up of offcuts of porcelain stoneware tiles*

→ **Formats:** most tiles are square or hexagonal. Their nominal dimensions are generally in the order of 20 × 20 cm, 25 × 25 cm, 30 × 30 cm, 40 × 40 cm. The thickness is variable according to the models and generally between 15 and 40 mm. Small models of 'cement' tiles (10 × 10 cm, 10 mm thick) are occasionally found and look like unglazed porcelain stoneware tiles. They are sometimes accompanied by straight, capped and high heel skirting boards.

→ **Finish:** the visible face can have a wide range of finishes: polished, softened, brushed, shot-peened, bush-hammered, sandblasted or scratched. Cement tiles are unglazed/engobed as they are not fired. Most cement tiles are impregnated with a water/oil repellent layer before being used.

→ **Texture:** mostly smooth and uniform for the upper surface. The edges are usually straight but due to their delicacy, slight chipping is common when reclaimed. The underside (not visible) is generally provided with a slight relief to improve adhesion to the substrate. In most cases, the acronym or the name of the manufacturer appears on the underside.

→ **Colours:** the colours are varied, generally solid, two-tone (speckled, flamed) or polychrome (patterned) for 'cement' tiles. The design of the patterns with respect to porcelain stoneware tiles is generally less clearly defined (this is also a clue to recognising them). The colours of 'terrazzo' tiles are defined by the colour, size and abundance of aggregates as well as by the pigments added to the cement.



### Design tip

*To increase the chances of meeting the offer available on the reclamation market, the designer/specifier can choose to split large surface areas into smaller quantity batches (for example, by providing different patterns in each room).*

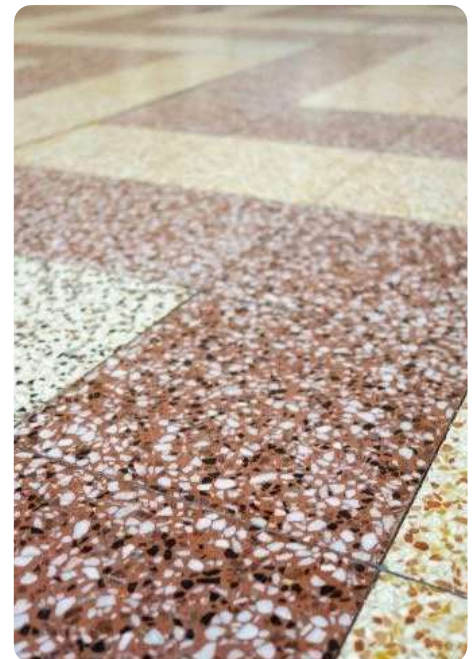

*Tiles before reuse*





**Material reclamation**

Cement-based tiles are often found as flooring in existing buildings. Their recovery is not always easy but can nevertheless represent a great opportunity for reuse, either on-site or via the professional channels of material resellers.



Mortar remains on edges and back side

→ **Dismantling tests:** dismantling tests make it possible to verify the feasibility and profitability of the removal. The type of laying (cement mortar on a stabilised sand bed, in fresh screed or adhesive mortar on dry screed) and the characteristics of the joints and tiles (thickness, composition) strongly affect the dismantling of the material.



Tile reclamation

→ **Removal:** careful dismantling should aim to ensure the integrity of the tiles and a certain uniformity of the batches. To minimise the risk of deterioration during dismantling, it is advisable to weaken the tensions within the tiles by first freeing 2 sides (perpendicular) of the tiles to be detached. This usually involves breaking non-free edge lines. The tiles will be sorted by quality, colour, size and degree of cleaning. They are stored on their edge thereby minimising the risk of abrasion. 'Face to face' storage will be preferred. Particular attention will be paid to batches characterised by a defined pattern and for which certain pieces must be recovered intact (e.g.: patterned carpet with frieze and corner pieces). Very often, reused cement tiles adhere strongly to the setting mortar. The cleaning of mortar remains is rarely carried out on-site and requires specific tools.



Mechanical cleaning

→ **Treatment:** the main treatment offered by the suppliers of reclaimed cement-based tiles is the mechanical cleaning of the remains of mortar on the underside and on the edges. This manual step is generally carried out using suitable tools (pneumatic chisel, plunge-cut saw, grinder, etc.) and requires systematic downstream sorting. Tiles with significant chips and knocks are downgraded. The cleaning of mortar remains on the sides is rarely carried out, which implies special arrangements at the time of laying (ask a professional tiler for advice). The cleaning service is a weighty operation resulting in a big difference in price between the cleaned tiles and the uncleaned tiles.

→ **Storage:** the tiles are stored in bulk on pallets or repackaged in bundles, taking the necessary precautions to minimise wear on the visible side (packaging in vertical position, layers separated by a plastic or 'Unalit' type sheet, stored face to face, etc.). The tiles must be stored away from frost and bad weather.

→ **Transport and delivery:** the necessary precautions must be taken during transport and delivery in order to minimise breakage (strapped, shrink wrapped pallet, etc.). It should be noted that the pre-packaged tiles facilitate installation.

It is advisable to involve specialised professionals to ensure the smooth running of these operations.



Few mortar remains after removal (hybrid mortar)



Reclaimed tiles

**Think reversible!**

The use of a hybrid mortar (lime-cement) or light cement mortar and cement-based joints without resin facilitates future dismantling. However, these laying methods have lower adhesion performance and will not be recommended for uses involving significant temperature variations and/or subjected to significant moving loads. Think about it when choosing the laying technique, it will increase the possibility of future reuse.



### Applications and laying

Reclaimed cement-based tiles are generally used as interior floor covering for applications subject to moderate stress (private accommodation) or more intense stress (entrance hall, retail space). As they are not too thick (less than 16 mm), they can also be used for wall application (tiles in this format are generally of more recent production). Porous in nature, *they are not recommended for outdoor use* and are moderately suitable for uses involving excess humidity (sanitary facilities) or staining and aggressive products (community kitchens, laboratories). If necessary, and with adequate maintenance, the surface of the tiles can be subjected to a water/oil repellent treatment, and special waterproofing precautions can be taken for the substrate.

As a general rule, the choice of tiles must take into account the expected stresses (see § 'characteristics and fitness for use'). In all cases, reference should be made to the European and national standards relating to the product (EN 13748-1 for terrazzo tiles) and to the rules of practice in force (or implementation standards).

As long as they are completely cleaned, the reinstatement of reclaimed tiles does not differ from that of equivalent new tiles. However, the presence of residual mortar may require special precautions. The cleaned, reclaimed tiles lend themselves to the same variety of laying methods, patterns and fittings. They raise the same points of attention, in particular: properties and condition of the substrate, products and techniques for laying and grouting, drying times and laying times, costs, expansion joints, finishing joints, flatness, separation layer, underlying insulation, underfloor heating, grinding after laying for terrazzo tiles, application of a pore filler, crystallisation, specific maintenance, etc.

The presence of residual mortar on the sides is not recommended (but is common!). Not only will this affect the nominal size of the joints, but it can also influence their colour and composition. As a rule, patterned tiles are laid with a thin seam to emphasise the junction points of the composition. These thin joints also improve transit comfort and limit the appearance of breakage.

Due to the wear characteristics of cement tiles, it is recommended that an effective mat is provided for heavy traffic applications.

Reclaimed cement-based tiles are relatively thick and therefore more difficult to lay over an existing floor.

To facilitate installation, the designer/specifier will take care to use batches with a certain degree of uniformity in terms of the following characteristics:

→ **Batch composition:** the batch must consist entirely of cement-based tiles.

→ **Dimensions:** the dimensions of the tiles must be uniform, including the thickness. Variations in thickness of 1 to 2 mm are however possible for hand-crafted tiles from the same batch. In the case of tiles whose edges have not been cleaned of the remains of mortar, it is important to take this into account. The dimensional tolerance will be determined by the designer/specifier according to the equipment, the thickness of the joints and the laying technique.

→ **Colour:** slight variations in colour are possible (even for new products). In the case of reclaimed cement-based tiles, these variations may be due to the original exposure. It is advisable to mix the tiles when laying. The designer can also opt expressly for a pattern including tiles of very different colours. This is one way to take advantage of a greater variety of reclaimed tiles that can lead to architecturally interesting results.

*Crazing or cracking of cement tiles is a set of capillary cracks affecting the visible face of the tile and arranged in a network of small meshes. This phenomenon is probably generated by alternate shrinkage and tension between the constituent layers of the tile. This phenomenon does not affect the durability of the tiles, but can influence their aesthetic appearance if the cracks become dirty. It is therefore important to provide for the application of a water-repellent/oil-repellent protective layer if the use of tiles involves the presence of liquid and potentially staining substances (kitchens, bathrooms, etc.).*

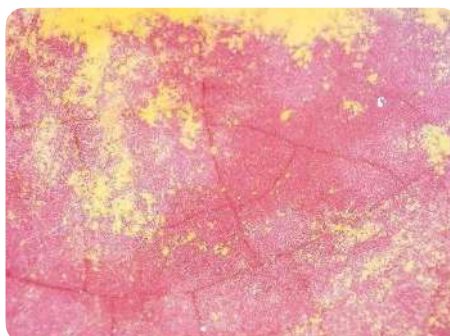

*Presence of a light clouding and crazing cracks. These cracks do not alter the technical characteristics of the tile.*

→ **Condition:** Reclaimed tiles may show signs of alterations such as signs of surface wear, chipped or cut edges, crazing cracks, etc. Some tiles may have swelling on their visible face. These are generally due to capillary rise occurring during their first use, and which causes lime hydrate deposits in the form of a cloud on the surface of the tiles. These swellings do not affect the longevity of the tiles. They can be removed by a specific abrasive treatment. *The use of aggressive detergents and acidic or alkaline products should however be avoided.*

It is up to the designer/specifier to define the degree of imperfection tolerated, according to the defined use, by specifying the maximum dimensions of the defects (for example, crazing: accepted, breaks and chipping < 25 mm?). This principle can be described in visual form to facilitate the examination of the tiles. Example:

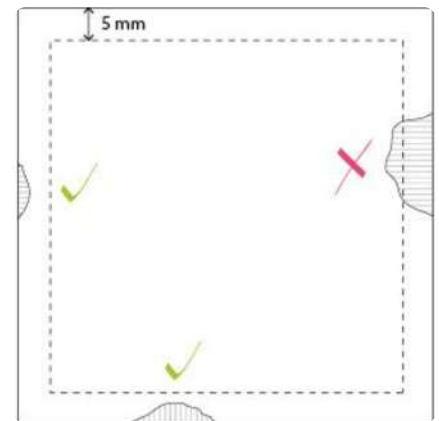

→ **Quantity:** some suppliers automatically include a 5% surplus when the product is delivered if they are not able to guarantee the absolute uniformity of the characteristics mentioned above. This surplus can also be applied in the case of an on-site salvage scenario.

Most professional suppliers are able to ensure that delivered batches meet these requirements.

Most of the reclaimed building materials are sold as is. The conditions of sale may however contain specific guarantees specific to the material. Some suppliers are able to indicate the origin of the material and/or provide documentation on the product purchased (for more information, see the introductory sheet).





### Characteristics and fitness for use

The harmonised European standard EN 13748-1 establishes the relevant characteristics (depending on the context) in order to determine the fitness for use of terrazzo tiles. Although detailed for new materials, these characteristics may prove useful in considering the specific case of reclaimed cement-based tiles.

In case of specific and demanding applications, parameters related to characteristics such as wear resistance, slip, modulus of rupture, etc., will have to be measured and quantified using tests carried out by approved laboratories.

Characteristics	Comments
<b>Dimensions (length, width)</b>	This characteristic is closely related to the degree of sorting and cleaning of reclaimed tiles. A visual or detailed examination of the batch is often sufficient to estimate it.
<b>Thickness</b>	The standard for new products indicates a requirement of 4 mm minimum thickness for the surface layer of double-layered terrazzo tiles not intended to be ground and 8 mm for those which will be ground after laying.
<b>Thickness</b>	A tolerance of $\pm 2$ mm is acceptable for new tiles with a thickness of $< 40$ mm
<b>Geometry (straightness of edges, angularity, flatness of the surface)</b>	For hand-made tiles, the lower face is not necessarily parallel to the upper face, however this irregularity can be easily remedied by means of adequate laying.
<b>Surface and edge quality</b>	This characteristic is closely related to the degree of sorting and cleaning of reclaimed tiles. A visual or detailed examination of the batch is often sufficient to estimate it. It should be mentioned that the edges of cement-based tiles are very fragile.
<b>Water absorption</b>	Porous in nature, cement tiles are susceptible to absorbing liquids. This characteristic concerns 1) <i>the lower face</i> , by which a rise in humidity promotes the appearance of swelling at the level of the visible surface, 2) <i>the edges</i> , for which it is not recommended to use a coloured jointing product, 3) <i>the upper face</i> for which it is advisable to apply a water/oil repellent coating product.
<b>Breaking strength/breaking load</b>	Mainly dependant upon the thickness and porosity of the tile. Older reclaimed cement-based tiles are generally quite thick ( $\geq 20$ mm) to meet this requirement. Contemporary production techniques have made it possible to bring thinner tiles to the market. The in-depth evaluation of this performance is relevant in case of high static and/or dynamic loads.
<b>Surface abrasion resistance (wear)</b>	/
<b>Slippage</b>	The usually smooth character of the surface can cause slippage. Smooth tiles will probably not be suitable for outdoor uses that are uncovered and/or regularly flooded (e.g.: Italian shower). Their performance should be particularly evaluated for intensive use and/or sloping ground.
<b>Reaction to fire</b>	In accordance with European Commission Decision 96/603/EC, terrazzo tile flooring is classified as non-combustible material and belongs to European reaction-to-fire class A1FL without prior testing.
<b>Stain resistance</b>	Given the porous nature of cement-based tiles, it is advisable to provide for the application of a water/oil-repellent protective layer (pore filler) to prevent stains.
<b>Resistance to low and high concentrations of acids and base products</b>	Untreated cement-based tiles are very sensitive to acids and base products.
<b>Thermal conductivity</b>	To be assessed if the tiles should contribute to the thermal performance of an element.
<b>VOC emissions</b>	Cement-based materials are considered to be low emitters of Volatile Organic Compounds. However, the laying and protection products can potentially emit VOCs.





**Availability**

Cement-based reclaimed tiles are relatively common in the salvage market. However, availability depends on the quantities required. As an example:

Frequent	Batch from 1 to 50 m <sup>2</sup>
Occasional	Batch from 50 to 100 m <sup>2</sup>
Rare	Batch > 100 m <sup>2</sup>

**Dismantling**

Dismantling efficiency: ~ 15 m<sup>2</sup> of tiles in good condition person/day

This rate includes laying, logistics and percentage of breakage. It varies according to the size of the tiles, the degree of adhesion of the mortar, the configuration of the building, etc.

**Indicative Prices (excl. tax)**

A non-exhaustive sample of the Western European reclaim market (Belgium, France, UK, and the Netherlands) has allowed us to extract some indicative prices:

Supply: depending on size, pattern, general condition, etc. (excluding antiques)

→ *Uncleaned reclaimed tiles:* 25 - 50 €/m<sup>2</sup>

→ *Cleaned reclaimed tiles:* 55 - 125 €/m<sup>2</sup>

**Embodied carbon (Cradle to gate – production A1-A3)**

	kg CO <sub>2</sub> eq./m <sup>2</sup>	kg CO <sub>2</sub> eq./kg
DNV – Life Cycle assessment on floor coverings *	9.6	0.21
ICE database (UK) *	5.3	0.12

\* Indicative values for terrazzo tiles with an average thickness of 10 mm and estimated density of 2300 kg/m<sup>3</sup>



Reusing 100 m<sup>2</sup> of tiles prevents the production of ~ 530 to ~ 960 kg of CO<sub>2</sub> equivalent related to the manufacture of new tiles (production phase only). This corresponds to a journey of ~ 3,200 to ~ 5,700 km in a small diesel car.

**Tips for distinguishing cement-based tiles from ceramic tiles**

→ *By eye:* the pattern of a ceramic tile appears to have been drawn with a pencil, and that of a cement-based tile with a thicker felt tip pen. The colours of the cement-based tile are more 'washed out', but once dampened, the colours become much more vivid. This contrast is less pronounced on ceramic tiles.

→ *By ear:* two ceramic tiles that are knocked together sound like glass, which is not the case for cement-based tiles. The cleaning potential of reclaimed cement tiles can reach around 10 to 20 m<sup>2</sup>/person per day with proper installation.

→ *By touch:* exposed to the sun, a ceramic tile is warmer to the touch than a cement-based tile.



Reused tiles (BE) @ Antony Nocera (Ceramica Concept)

**Did you know?**

Contemporary cement tiles are generally produced in Morocco. Each worker is able to manually manufacture about 4 m<sup>2</sup>/day. The resale price of new tiles on the NWE market varies between 60 and 150 euros/m<sup>2</sup>.

The cleaning potential of reclaimed cement tiles can reach around 10 to 20 m<sup>2</sup>/person per day with proper installation.

**Find specialised businesses**



[salvoweb.com](http://salvoweb.com)

[opalis.eu](http://opalis.eu)

**Disclaimer**

This sheet is intended for designers, specifiers and other members of construction project teams wishing to reuse this building material or product. It is part of a collection of sheets aimed at bringing together the available information to date that is likely to facilitate the reuse of building materials and products.

This sheet has been produced by Rotor vzw/asbl within the framework of the Interreg FCRBE project - Facilitating the Circulation of Reclaimed Building Elements, supported by the entire project partnership. Sources of information include the experience of reclamation dealers and involved project partners, lessons learned from exemplary projects, available technical documentation, etc.

The sheets have been produced between 2019 and 2021. As the reclamation sector is evolving, some information, notably regarding pricing and availability, may change over the time. When the text refers to European standards, it is up to the project team to refer, if necessary, to their national implementations and local specificities.

It is important to note that the information presented here is not exhaustive or intended to replace the expertise of professionals. Specific questions are always project related and should be treated as such.

The complete collection of sheets (including the introductory sheet) is freely available from different reference websites (a.o. [opalis.eu](http://opalis.eu), [nweurope.eu/fcrbe](http://nweurope.eu/fcrbe), [futureuse.co.uk](http://futureuse.co.uk)).

Non-exhaustive directories of dealers in reclaimed building materials are available on [www.opalis.eu](http://www.opalis.eu) and [www.salvoweb.com](http://www.salvoweb.com).

---

Interreg FCRBE partnership: Bellastock (FR), the Belgian Building Research Institute / BBRI (BE), Brussels Environment (BE), the Scientific and Technical Center of Building / CSTB (FR), Confederation of Construction (BE), Rotor (BE), Salvo (UK) and University of Brighton (UK).

The information contained in this document does not necessarily reflect the position of all the FCRBE project partners nor that of the funding authorities.

Unless explicitly stated otherwise, the content of these sheets is credited in the Creative Commons Attribution NonCommercial – Share Alike format (CCBY-NC-SA).



Unless explicitly stated, the images used in this document belong to © Rotor vzw/asbl or © Opalis. Any other image has been the subject of a systematic request for authorisation from their authors or rightful owners. When this request has not been answered, we assumed that there were no objections to the use of the image. If you feel that this interpretation is unreasonable, please let us know.



**Material Description**

Unglazed terracotta tiles are obtained by firing clays (or loams) and sands previously mixed and degassed; shaped by extrusion (extruded tiles), moulded or pre-formed; dried and finally fired at a temperature of 900 to 1050 °C for 12 to 48 hours. It is a ceramic material manufactured by hand or industrially, the properties of which depend essentially on the mixture's composition, the firing temperature and the technical skill used in the manufacture.

Unglazed terracotta tiles are characterised by *high strength*, relatively good resistance to wear and puncture, as well as good thermal inertia (accumulation and conduction of heat), ideal for heated floors.

In the raw state, the most common reclaimed terracotta tiles are generally *porous*, which translates into high water absorption, low frost resistance, high sensitivity to stains and poor mechanical performance for the large size and thin models. They are generally intended for indoor use and most often require a protective finish and regular maintenance. Outdoor use is possible in some cases.

Nevertheless, the modernisation of production techniques has allowed the emergence of terracotta tiles for outdoor use offering sufficient resistance to frost. However, these tiles are not easily found on the reclamation market.

The tiles referred to in this sheet are unglazed/engobed and should be distinguished from slabs (larger dimensions and thickness) and terracotta pavers (box shaped format), which can also be used for exterior applications.

Produced in abundance in Europe, and particularly in the south, since the 19th century, they are readily found on the reclamation market. We often find certain models under the name 'tomettes' or 'terracotta'. They should not be confused with their counterparts in extruded stoneware and porcelain stoneware.



Example of 'parefeuilles'



In the South of France, there are rectangular tiles called '*parefeuilles*' or '*covered boxes*', sold as interior floor tiles. Originally, the reclaimed '*parefeuilles*' were installed in under-roof insulation. They are porous tiles and quite sensitive to stains. Ask the dealer for advice.



**Design Tip!**

To increase the chances of meeting the offer available on the reclamation market, the designer/specifier can choose to split large surfaces into smaller quantity batches (for example, by providing different patterns in each room).





## Unglazed terracotta tiles

→ **Formats:** There is a wide variety of formats, usually associated with their region of origin. Most tiles are square, hexagonal, octagonal or rectangular in shape. Their nominal dimensions are generally in the order of 10 × 10 cm, 12 × 12 cm, 14 × 14 cm, 16 × 16 cm, 30 × 30 cm. The thickness is variable according to the models and generally between 12 and 25 mm. There are also parts such as skirting boards, stair profiles, edges, etc.

→ **Finish:** the rough finish of manufactured terracotta tiles is generally characterised by a rather matte, rough or smooth surface, relatively irregular and with slightly rounded edges. Several levels of mechanical finishes are also found on the market, for example: split edges, extra-smooth,

structured surface, brushed, sandblasted, glazed (not covered in this sheet), etc. The tiles which have been used indoors have generally undergone a water/oil repellent protective treatment and have a matte, satin or gloss appearance.

→ **Texture:** the tiles often have a very uneven appearance and the pores are easily visible. Some so-called 'rustic' tiles have been produced from unpurified and coarsely ground clays, bringing out grains, stones and encrustation on the surface. More or less large cavities may appear on the surface. The underside (not visible) is generally provided with a slight relief to improve adhesion to the substrate. The abbreviation or manufacturer's name often appears on the underside.

→ **Colours:** the nuances of colours are influenced by the clay used and the content of iron oxides. Mixtures are frequent and are mainly due to the firing method (wood fire) and the position of the tiles in the kiln. For handmade tiles, a dark colour will mean a higher temperature rise and improved robustness. Traditional colours are pink, red, and coppery-orange while more contemporary colours may lean towards white, grey, ochre, and brown.







**Material reclamation**

Unglazed terracotta tiles are found in interior or exterior applications in a wide range of buildings, but mainly in rural residential and/or heritage contexts. If the tiles do not find a new use directly on site, they can be sent to professional reclaimed channels.

→ *Dismantling tests*: dismantling tests make it possible to verify removal feasibility and profitability. Type of laying (insertion sealed with a lime, lime/cement or cement mortar or bonded with a tile adhesive), joint and tile characteristics (thickness, composition) strongly affect the removability of the material.

→ *Reclamation*: careful dismantling should aim to ensure the tile integrity and a certain uniformity of the batches. To minimise the risk of deterioration during dismantling, it is advisable to weaken the tensions within the tiles by first freeing 2 sides (perpendicular) of the tiles to be detached. This usually involves breaking non-free edge lines. The tiles will be sorted by quality, colour, size and degree of cleaning. They will preferably be stored on their edge in order to limit the risk of breakage.

→ *Treatment*: the main treatments offered by the suppliers of reclaimed terracotta tiles are the surface cleaning and the mechanical cleaning of the remains of mortar on the underside and on the edges. This manual step is generally carried out using suitable tools (pneumatic chisel, circular saw, grinder, etc.) and requires systematic downstream sorting. Tiles that are friable or showing significant chips and knocks are downgraded.

→ *Storage*: the batches of tiles are stored in bulk on pallets or repackaged in bundles, taking the necessary precautions to limit the risk of breakage (packaging on their edge, separation of layers, etc.). Old (porous) and interior tiles will be stored away from frost and bad weather. Owing to their porosity, poorly stored tiles can develop algae and mould, which can leave irreversible stains on the surface.

→ *Transport and delivery*: the necessary precautions must be taken during transport and delivery in order to minimise breakage (strapped, shrink wrapped pallet, etc.). On site, tiles for indoor use must be stored away from frost and bad weather. It is advisable to involve specialised professionals to ensure the smooth running of these operations.

It is advisable to involve specialised professionals to ensure the smooth running of these operations.



Tile front



Tile backside



Tile front



Tile backside



Mechanical cleaning



Storage



Storage



Storage



**Applications and laying**

Reclaimed terracotta tiles are mainly used as indoor flooring for applications subject to moderate stress (private homes, hallways, etc.). They do not lend themselves well to wall applications. Porous in nature, most used terracotta tiles are not recommended for outdoor use, unless their suitability for this use can be demonstrated. They are not suitable for uses subject to intense wear (concourse, commercial area, passage of wheeled vehicles, etc.), or uses involving excess humidity (sanitary facilities) or staining and aggressive products (community kitchens, restaurants, laboratories).

As a general rule, the choice of tiles must take into account the expected stresses (see § 'characteristics and fitness for use'). In all cases, reference should be made to the European and national standards relating to the product (EN 14411) and to the rules of practice in force (or implementation standards).

The reuse of completely cleaned reclaimed terracotta tiles is no different from that of new tiles. They lend themselves to the same diversity of laying methods, patterns and fittings. They raise the same points of attention, in particular: properties and condition of the substrate, products and techniques for laying and grouting, drying times and laying times, costs, expansion joints, finishing joints, flatness, separation layer and waterproofing, underlying insulation, under-floor heating, application of a pore filler, specific maintenance, etc. For exterior tiles, attention should be paid to the slope, drainage, risk of swelling, etc.

Tiles of irregular thickness or showing residual traces of mortar on the underside will be limited to an embedded laying (traditional laying with mortar) in order to make up for differences in thickness. In this case, the use of adhesive mortar should be avoided. Likewise, the possible presence of residual mortar on the edges can affect the nominal size of the joints as well as their colour and composition.

Terracotta is a porous material requiring, during use, an adequate water/oil-repellent treatment to be renewed periodically (for example: waxes, resins, oil-based saturators, linseed oil and turpentine, etc.). Reclaimed tiles are likely to be completely or partially covered by the old impregnation layer. Depending on the aesthetic state of the patina, it is possible to remove this layer through

*Think reversible!*

*The use of a hybrid mortar (lime-cement) and resin-free joints facilitate future dismantling. However, this laying method is not suitable for all situations and involves consequences in terms of adhesion performance, laying costs, delays, etc. Think about it when choosing the laying technique, it will increase the possibility of future reuse.*

stripping (chemical, airbrushing, etc.) before proceeding with the new protective treatment. In all cases, terracotta tiles require regular and specific maintenance.

To facilitate laying, the designer/specifier will take care to use batches with a certain degree of uniformity in terms of the following characteristics:

→ **Batch composition:** the batch must consist entirely of terracotta tiles.

→ **Dimensions:** the dimensions of the tiles must be uniform, including the thickness. Variations in thickness of 1 to 2 mm are however possible for hand-crafted tiles from the same batch. In the case of tiles whose edges have not been cleaned of the remains of mortar, it is important to take this into account. The dimensional tolerance will be determined by the specifier according to the equipment, the thickness of the joints and the laying technique.



Example of imperfection

→ **Colour:** variations in colour are possible (even for new products). In the case of reclaimed terracotta tiles, these variations may be due to the production method, the original exposure, previously applied treatments, etc. It is advisable to mix the tiles when laying.



Variations in colour

→ **Condition:** reclaimed tiles may have alterations such as traces of surface wear, chipped or cut edges, stains, traces of mould, swelling, etc. It is up to the designer/specifier to define the degree of imperfection tolerated, according to the defined use, by specifying the maximum dimensions of the defects (for example, breaks and chipping <25 mm<sup>2</sup>). This principle can be described in visual form to facilitate the examination of the tiles. Example:

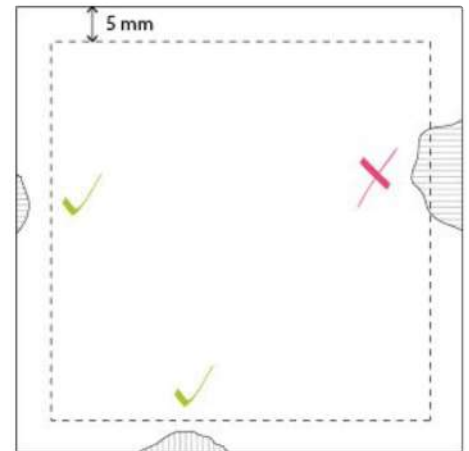

→ **Quantity:** some suppliers may include a 5% surplus when the product is delivered if they are not able to guarantee the absolute uniformity of the characteristics mentioned above. This surplus can also be applied in the case of an on-site salvage scenario.Â

Most professional suppliers are able to ensure that delivered batches meet these requirements.

Most of the reclaimed building materials are sold as is. The conditions of sale may however contain special guarantees specific to the material. Some suppliers are able to indicate the origin of the material and/or provide documentation on the product purchased (for more information, see the introductory sheet).



**Characteristics and fitness for use**

The harmonised European standard EN 14411 establishes the relevant characteristics (depending on the context) in order to determine the fitness for use of ceramic tiles. Although detailed for new materials, these characteristics may prove useful in considering the specific case of reclaimed unglazed terracotta tiles (internal and external floor applications).

Characteristics	Int.	Ext.	Comments
<b>Dimensions (length, width)</b>	x	x	This characteristic is closely related to the degree of sorting and cleaning of reclaimed tiles. A visual or detailed examination of the batch is often sufficient to estimate it. The irregularity of the tiles will influence the thickness of the joints during laying.
<b>Thickness</b>	x	x	A variation of $\pm 10\%$ is tolerated for most new terracotta tiles. These variations, as well as the significant thickness of certain types of tiles, must be considered when laying, particularly in the event of renovation (for example: repercussions on the height of the floor).
<b>Geometry (straightness of edges, angularity, flatness of the surface)</b>	x	x	A visual or detailed examination of the batch is often sufficient to estimate these characteristics. Bowed tiles should be avoided in outdoor use in order to limit water stagnation.
<b>Surface quality</b>	x	x	This characteristic is closely related to the degree of sorting and cleaning of reclaimed tiles. A visual or detailed examination of the batch is often sufficient to estimate it. Particular attention will be paid to the presence of stains or mould given their potentially irreversible nature.
<b>Water absorption</b>	x	x	Terracotta tiles vary in porosity and are susceptible to absorbing liquids. This characteristic concerns 1) the lower face, by which a rise in humidity promotes the appearance of swelling at the level of the visible surface, 2) the edges, for which it is not recommended to use a coloured jointing product, 3) the upper face for which it is advisable to apply a water/oil-repellent coating product for interior use.
<b>Breaking strength/breaking load</b>	x	x	Mainly dependent upon the thickness and porosity of the tile. Older reclaimed terracotta tiles are usually very thick ( $\geq 20$ mm) to meet this requirement. Contemporary production techniques have made it possible to bring thinner tiles to the market. The in-depth evaluation of this performance is relevant in case of high static and/or dynamic loads.
<b>Abrasion resistance (wear)</b>	x	x	Terracotta tiles have low to medium wear resistance. This characteristic excludes their use for heavy-duty applications (for example: schools, supermarkets, passages of wheeled vehicles, etc.)
<b>Shock resistance</b>	x	x	To be considered in areas where impact resistance is considered to be of particular importance.
<b>Slippage</b>	x	x	The generally rough nature of terracotta tiles improves their slip performance. This characteristic deserves to be evaluated for more intensive use, in exterior application and/or for inclined floors. It will be assessed with regard to the degree of wear, dirt, floor maintenance and surface treatment.
<b>Reaction to fire</b>	x		In accordance with European Commission Decision 96/603/EC, ceramic tile floor coverings, without finishing coat, are classified as non-combustible materials and belong to the European reaction to fire class A1 <sub>FL</sub> without prior testing.
<b>Freeze/thaw resistance</b>		x	This performance determines the restriction for outdoor use. The porous nature of most used terracotta tiles limits their use to interior use. However, some tiles can meet this performance. For example, it is possible to ensure this by selecting only batches dismantled from outdoor use.
<b>Stain resistance</b>	x	x	Due to the porous nature, terracotta tiles are inherently very sensitive to stains. It is therefore advisable to provide for the application of a water/oil-repellent protective layer (pore-filler) during laying as well as a periodic renewal of the treatment.
<b>Resistance to low and high concentrations of acids and base products</b>	x	x	Terracotta tiles are generally resistant to common chemicals. A jointing product corresponding to this requirement should be provided.
<b>Linear thermal expansion</b>	x	x	Low for most ceramic tiles, which is suitable for underfloor heating systems.
<b>Thermal conductivity</b>	x		To be assessed if the tiles should contribute to the thermal performance of an element.
<b>VOC emissions</b>	x		Volatile Organic Compounds are destroyed at the time of combustion of organic materials possibly present in clay raw materials. The original terracotta tiles are therefore considered to be free of VOCs. However, reclaimed tiles may have been "polluted" by substances during their use phase (e.g. laying products, finishing products, etc.).

In case of specific and demanding applications, parameters related to characteristics such as wear resistance, frost resistance, slip, modulus of rupture, etc., will have to be measured and quantified using tests carried out by approved laboratories.



**Availability**

Reclaimed unglazed terracotta tiles are a relatively common product in the reclamation market. However, availability depends on the quantities required. As an example:

Frequent	Batch from 1 to 50 m <sup>2</sup>
Occasional	Batch from 50 to 100 m <sup>2</sup>
Rare	Batch > 100 m <sup>2</sup>

**Find specialised businesses**

**SALVO** salvoweb.com **OPALIS** opalis.eu

**Indicative Prices (excl. tax)**

A non-exhaustive sample of the Western European reclaim market (Belgium, France, UK, and the Netherlands) has allowed us to extract some indicative prices:

→ Cost of removal: 15-25 €/m<sup>2</sup>

Supply: depending on size, general condition, etc. (excluding antiques)

→ Cleaned reclaimed terracotta tiles: 50-90 €/m<sup>2</sup>

→ New terracotta tiles: 25-90 €/m<sup>2</sup>

→ Protective treatment and finishing: 8-16 €/m<sup>2</sup>

**Hazardous substances and precautions**

During the first half of the 20th century, terracotta tiles were often covered with a red paint (called 'Prussian Red') which could contain lead and emit toxic gases in the presence of acid. The necessary precautionary measures must be taken before re-using or renovating floors with red paint residues.



'Prussian Red' paint: warning!

**Embodied carbon (Cradle to gate – production A1-A3)**

	kg CO <sub>2</sub> eq./m <sup>2</sup>	kg CO <sub>2</sub> eq./k
INIES database (FR) – Generic data	27.2	1
CTMNC – Collective declaration	21.6	0.8

Indicative values for an average thickness of 10 mm and estimated density of 2300 kg/m<sup>3</sup>



Reusing 100 m<sup>2</sup> of tiles prevents the production of ~ 1000 to ~ 1800 kg of CO<sub>2</sub> equivalent related to the manufacture of new tiles (production phase only). This corresponds to a journey of ~ 6000 to ~ 11,500 km in a small diesel car.



Reused tiles in 'Old Marbrerie Albert' (BE) © François de Ribaucourt

**Disclaimer**

This sheet is intended for designers, specifiers and other members of construction project teams wishing to reuse this building material or product. It is part of a collection of sheets aimed at bringing together the available information to date that is likely to facilitate the reuse of building materials and products.

This sheet has been produced by Rotor vzw/asbl within the framework of the Interreg FCRBE project - Facilitating the Circulation of Reclaimed Building Elements, supported by the entire project partnership. Sources of information include the experience of reclamation dealers and involved project partners, lessons learned from exemplary projects, available technical documentation, etc.

The sheets have been produced between 2019 and 2021. As the reclamation sector is evolving, some information, notably regarding pricing and availability, may change over the time. When the text refers to European standards, it is up to the project team to refer, if necessary, to their national implementations and local specificities.

It is important to note that the information presented here is not exhaustive or intended to replace the expertise of professionals. Specific questions are always project related and should be treated as such.

The complete collection of sheets (including the introductory sheet) is freely available from different reference websites (a.o. [opalis.eu](http://opalis.eu), [nweurope.eu/fcrbe](http://nweurope.eu/fcrbe), [futureuse.co.uk](http://futureuse.co.uk)).

Non-exhaustive directories of dealers in reclaimed building materials are available on [www.opalis.eu](http://www.opalis.eu) and [www.salvoweb.com](http://www.salvoweb.com).

---

Interreg FCRBE partnership: Bellastock (FR), the Belgian Building Research Institute / BBRI (BE), Brussels Environment (BE), the Scientific and Technical Center of Building / CSTB (FR), Confederation of Construction (BE), Rotor (BE), Salvo (UK) and University of Brighton (UK).

The information contained in this document does not necessarily reflect the position of all the FCRBE project partners nor that of the funding authorities.

Unless explicitly stated otherwise, the content of these sheets is credited in the Creative Commons Attribution NonCommercial – Share Alike format (CCBY-NC-SA).



Unless explicitly stated, the images used in this document belong to © Rotor vzw/asbl or © Opalis. Any other image has been the subject of a systematic request for authorisation from their authors or rightful owners. When this request has not been answered, we assumed that there were no objections to the use of the image. If you feel that this interpretation is unreasonable, please let us know.





**Material Description**

Unglazed porcelain stoneware tiles (hereinafter referred to simply as 'tiles') are suitable for reuse. Their composition based on clays and feldspar and their production involving pressing and firing at 1300 °C ensure their high resistance. They are very hard, scratch-resistant, non-porous and frost-resistant. Produced in abundance in Europe from the beginning of the 20th century until the 1980s, they are frequently found in private and public buildings and community facilities, mainly in the form of interior floor coverings. They are readily found on the reclamation market. The tiles referred to here are dry pressed and unglazed/engobed. They should not be confused with their counterparts in extruded stoneware, terracotta or cement-based, which are often more porous and/or more sensitive to wear.



→ **Formats:** most tiles are square, hexagonal and octagonal (+ cabochons). Their nominal dimensions are generally in the order of 10 × 10 cm, 13 × 13 cm, 15 × 15 cm and 20 × 20 cm. The thickness varies depending on the model, but they are rarely thicker than 2.5 cm. Straight, grooved and high heel skirting boards associated with this material are rarely salvageable and are therefore rarely reused.

→ **Finish:** unglazed/engobed.

→ **Texture:** upper surface (visible) mostly smooth and uniform, rarely with relief. The

edges are smooth and straight. Occasionally, the tiles are ground (slightly bevel) on the upper edge. The underside (not visible) is provided with a slight relief for reasons of adhesion to the substrate.



Rectified tile

→ **Colours:** the colours are varied, solid, two-tone (speckled, flamed) or polychrome (flowery, etc.). The design of the patterns is very clear. Reclaimed tiles are very often 'full body', single or double-layered. In the former case, the colour is uniform throughout the thickness and surface wear has less effect on the aesthetic qualities. It is advisable to involve specialised professionals to ensure the smooth running of these operations



Single-layer tile



Double-layer tile



Double-layer tile

**Material reclamation**

→ **Dismantling tests:** Dismantling tests make it possible to check the feasibility of removal. Generally, tiles laid on adhesive mortar or accessories such as skirting boards are often difficult to remove properly.

→ **Removal:** careful dismantling should aim to ensure the integrity of the tiles and a certain uniformity of the batches. To minimise the risk of deterioration during dismantling, it is advisable to weaken the tensions within the tiles by first freeing 2 sides (perpendicular) of the tiles to be detached. This usually involves breaking non-free edge lines. The tiles will be sorted by quality, colour, size and degree of cleaning. Particular attention will be paid to batches characterised by a defined pattern and for which certain pieces must be recovered intact (e.g.: patterned carpet with frieze and corner pieces).

→ **Treatment:** tile edges and undersides are cleaned to make installation easier. Most reclaimed tile suppliers clean the batches they resell by mechanical treatment and, less commonly, by physicochemical treatment. Some offer this service separately. Generally, the tiles are not degreased and some stains are to be removed after refitting.

→ **Storage:** Tiles are stored in bulk on pallets, in boxes or reconditioned in bundles. Ideally, the tiles should be stored away from the elements to prevent water condensation which can lead to the development of mould.

→ **Transport and delivery:** the necessary precautions must be taken during transport and delivery in order to minimise breakage (strapped, shrink wrapped pallet etc.). It should be noted that pre-packaged facilitate laying.



Tile dismantling



Reclaimed tiles



Reclaimed tiles in packets



**Applications and laying**

Reclaimed unglazed porcelain stoneware tiles can be applied both indoors and outdoors. They are generally used as floor coverings for applications subject to moderate stress (private accommodation) or more intense stress (entrance hall, retail space). When they are not too thick, they can also be used for wall application. Very slightly porous, they are suitable for uses involving humidity (sanitary facilities) or staining and aggressive products (kitchens, laboratories).

**Think reversible!**

*The use of a hybrid mortar (lime-cement) and cement-based joints without resin facilitates future dismantling. However, these laying methods have lower adhesion. They are also not recommended for uses involving significant temperature variations or significant moving loads.*

The choice of tiles must, however, take into account the expected stresses (see § 'characteristics and fitness for use' below). In all cases, reference should be made to the European and national standards relating to the product (EN 14411) and to the rules of practice in force (or implementation standards).

The reuse of completely cleaned reclaimed tiles is no different from that of new tiles. They lend themselves to the same diversity of installation methods, patterns and fittings. They raise the same points of attention, in particular: properties and condition of the substrate, products and techniques for laying and grouting, drying times and laying times, costs, expansion joints, finishing joints, flatness, separation layer, underlying insulation, underfloor heating, etc.

Tiles showing residual traces of mortar on the underside will be limited to laying in a fresh screed or in mortar on a stabilised sand bed or hardened substrate, in order to make up for differences in thickness. In this case, the use of adhesive mortar should be avoided. Likewise, the possible presence of residual mortar on the edges can affect the nominal size of the joints as well as their colour and composition

To facilitate installation, the designer/specifier will take care to use batches with a certain degree of uniformity in terms of the following characteristics:

→ **Batch composition:** the batch must consist entirely of unglazed porcelain stoneware tiles.

→ **Dimensions:** the dimensions of the tiles must be uniform, including their thickness. The dimensional tolerance is determined by the designer/specifier according to the equipment, the thickness of the joints and the laying technique.

→ **Colour:** slight variations in colour are possible (even for new products). In the case of reclaimed tiles, these variations may be due to the original exposure. It is advisable to mix the tiles when laying. The designer can also opt expressly for a pattern including tiles of very different colours. This is one way to take advantage of a greater variety of reclaimed tiles that can lead to architecturally interesting results.

Most the reclaimed building materials are sold as is. The conditions of sale may however contain specific guarantees specific to the material. Some suppliers are able to indicate the origin of the material and/or provide documentation on the product purchased (for more information, see the introductory sheet).

→ **Condition:** reclaimed tiles may show signs of deterioration such as signs of surface wear, chipped or cut edges, cracks, etc.

It is up to the designer/specifier to define the degree of imperfection tolerated, with regard to the intended use, by specifying the acceptance or rejection of these defects (for example, breaks and chipping < 25 mm<sup>2</sup>). This principle can be described in visual form to facilitate the examination of the tiles. Example:

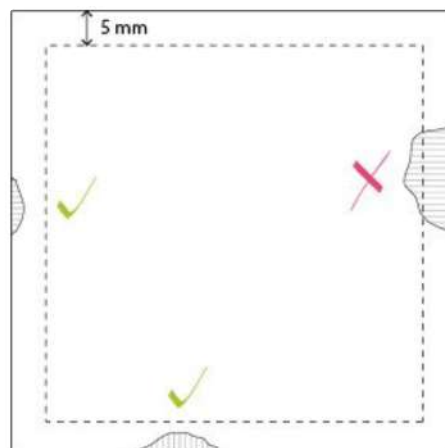

→ **Quantity:** some suppliers can include a 5% surplus when the product is delivered if they are not able to guarantee the absolute uniformity of the characteristics mentioned above. This surplus can also be applied in the case of an on-site salvage scenario.

To facilitate installation, the designer/specifier will take care to use batches with a certain degree

Most professional suppliers are able to ensure that delivered batches meet these requirements



Tile cleaning station



Variations in colour



Chipped corner



Crack



**Characteristics and fitness for use**

The harmonised European standard EN 14411 establishes the relevant characteristics (depending on the context) in order to determine the fitness for use of ceramic tiles. Although detailed for new materials, these characteristics may prove useful in considering the specific case of reclaimed unglazed porcelain stoneware tiles (internal and external floor applications).

Characteristics	Floors		Walls		Comments
	Int.	Ext.	Int.	Ext.	
<b>Dimensions (length, width, thickness)</b>	x	x	x	x	This characteristic is closely related to the degree of sorting and cleaning of reclaimed tiles. A visual or detailed examination of the batch is often sufficient to estimate it.
<b>Geometry (straightness of edges, angularity, flatness of the surface)</b>	x	x	x	x	ditto
<b>Surface quality</b>	x	x	x	x	ditto
<b>Water absorption</b>	x	x	x	x	By their nature, unglazed porcelain stoneware tiles generally have a very low water absorption coefficient (<0.5%).
<b>For specific uses</b>					
<b>Modulus of rupture</b>	x	x	x	x	Mainly depending on the thickness of the tile. Relevant performance to be assessed in the event of high static and/or dynamic loads.
<b>Resistance to deep abrasion</b>	x	x			By their nature, these tiles are generally very resistant to wear. The fact that these tiles have a coloured body and are unglazed generally contributes to improve this characteristic. Important performance relevant to evaluate in spaces subject to intensive traffic (station concourse, airports, industrial workshops, etc.).
<b>Linear thermal expansion</b>	x	x	x	x	Low for most ceramic tiles.
<b>Thermal shock resistance</b>	x	x	x	x	For specific applications where tiles are subjected to high temperature gradients.
<b>Freeze/thaw resistance</b>		x		x	The low porosity of porcelain stoneware tiles generally gives them a frost-resistant character.
<b>Slippage</b>	x	x			The usually smooth character of the surface can cause slippage. Smooth tiles will probably not be suitable for outdoor uses that are uncovered and/or regularly flooded (e.g.: Italian shower). Their performance should be particularly evaluated for intensive use and/or sloping ground.
<b>Adhesion to adhesive mortars, dispersion adhesives or reactive adhesives</b>			x	x	Depending on the type of laying recommended for wall application.
<b>Moisture expansion</b>	x	x	x	x	Low for most ceramic tiles.
<b>Slight colour differences</b>	x	x	x	x	For specific applications.
<b>Shock resistance</b>	x	x			To be considered in areas where impact resistance is considered to be of particular importance.
<b>Reaction to fire</b>	x		x	x	In accordance with European Commission Decision 96/603/EC, ceramic tile floor coverings are classified as non-combustible materials and belong to the European reaction to fire class A1 <sub>FL</sub> without prior testing.
<b>Tactility</b>	x	x			Essential characteristic for tactile paving – visually impaired people. Very specific use.
<b>Stain resistance</b>	x	x	x	x	The low porosity of tiles generally gives them good stain resistance.
<b>Resistance to low and high concentrations of acids and base products</b>	x	x	x	x	Ceramic tiles are generally resistant to common chemicals.
<b>Resistance to household products</b>	x	x	x	x	Ceramic tiles are generally resistant to common chemicals.
<b>Thermal conductivity</b>	x				To be assessed if the tiles should contribute to the thermal performance of an element.
<b>VOC emissions</b>	x		x		Volatile Organic Compounds are destroyed at the time of combustion of organic materials possibly present in clay raw materials. Ceramic tiles are therefore considered to be free of VOCs. However, the laying and protection products can potentially emit VOCs.





**Availability**

Unglazed porcelain stoneware ceramic tiles are a relatively common product in the reclamation market. However, availability depends a lot on the quantities required. As an example:

Frequent	Batch from 0 to 50 m <sup>2</sup>
Ocasional	Batch from 50 to 100 m <sup>2</sup>
Rare	Batch > 100 m <sup>2</sup>

*Design tip*

To increase the chances of meeting the offer available on the reclamation market, the designer/specifier can choose to split large surface areas into smaller quantity batches (for example, by providing different patterns in each room).

**Dismantling**

Dismantling efficiency: ~ 15 m<sup>2</sup> of tiles in good condition person/day

This rate includes laying, logistics and percentage of breakage. It varies according to the size of the tiles, the degree of adhesion of the mortar, the configuration of the building, etc.



**Indicative Prices (excl. tax)**

A non-exhaustive sample of the Western European reclaim market (Belgium, France, UK, and the Netherlands) has allowed us to extract some indicative prices:

→ Cost of removal: 15 - 25 €/m<sup>2</sup>

→ Cleaning service: 25 - 35 €/m<sup>2</sup>

*Supply:* depending on size, pattern, general condition, etc. (excluding antiques)

→ Cleaned tiles: 50 - 85 €/m<sup>2</sup>

→ Uncleaned tiles: 25 - 50 €/m<sup>2</sup>

**Embodied carbon (Cradle to gate - production A1-A3)**

	kg CO <sub>2</sub> eq./m <sup>2</sup>	kg CO <sub>2</sub> eq./kg
INIES database (FR) – Generic data	9.29	0.40
ICE database (UK)	17.94	0.78

Indicative values for an average thickness of 10 mm and estimated density of 2300 kg/m<sup>3</sup>

 Reusing 100 m<sup>2</sup> of tiles prevents the production of ~ 1000 to ~ 1800 kg of CO<sub>2</sub> equivalent related to the manufacture of new tiles (production phase only). This corresponds to a journey of ~ 6000 to ~ 11,500 km in a small diesel car.

**Hazardous substances and precautions**

*Asbestos:* Some tile adhesives used before 1990 may contain asbestos. Even if the risk is low (< 1 to 10% depending on the application and the countries), adequate measures must be taken in order to make a correct diagnosis. The risk is slightly higher for adhesives used in skirting board applications. The presence of asbestos in expansion joints is also possible.

*Did you know?*

A life cycle analysis carried out on a process for cleaning reclaimed tiles by a Brussels-based company showed that their environmental impact was 2 to 6 times less than that of a new tile.

Source: Careno project (Be Circular 2016) led by Rotor and the BBRI (Belgian Building Research Institute – Belgium). Details of this study are available on request (info@rotordb.org)

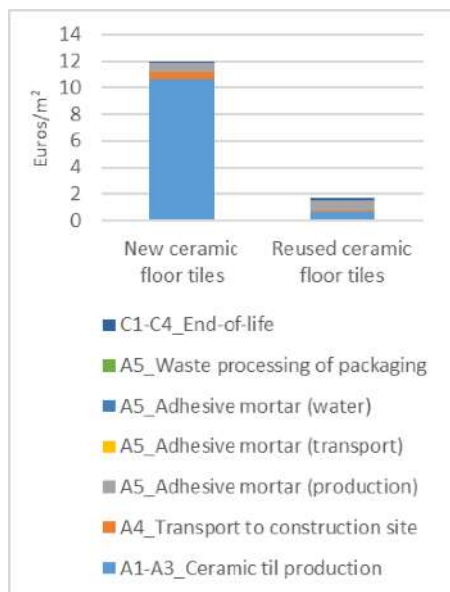

**Find specialised businesses**



[salvoweb.com](http://salvoweb.com)

[opalis.eu](http://opalis.eu)



**Disclaimer**

This sheet is intended for designers, specifiers and other members of construction project teams wishing to reuse this building material or product. It is part of a collection of sheets aimed at bringing together the available information to date that is likely to facilitate the reuse of building materials and products.

This sheet has been produced by Rotor vzw/asbl within the framework of the Interreg FCRBE project - Facilitating the Circulation of Reclaimed Building Elements, supported by the entire project partnership. Sources of information include the experience of reclamation dealers and involved project partners, lessons learned from exemplary projects, available technical documentation, etc.

The sheets have been produced between 2019 and 2021. As the reclamation sector is evolving, some information, notably regarding pricing and availability, may change over the time. When the text refers to European standards, it is up to the project team to refer, if necessary, to their national implementations and local specificities.

It is important to note that the information presented here is not exhaustive or intended to replace the expertise of professionals. Specific questions are always project related and should be treated as such.

The complete collection of sheets (including the introductory sheet) is freely available from different reference websites (a.o. [opalis.eu](http://opalis.eu), [nweurope.eu/fcrbe](http://nweurope.eu/fcrbe), [futureuse.co.uk](http://futureuse.co.uk)).

Non-exhaustive directories of dealers in reclaimed building materials are available on [www.opalis.eu](http://www.opalis.eu) and [www.salvoweb.com](http://www.salvoweb.com).

---

Interreg FCRBE partnership: Bellastock (FR), the Belgian Building Research Institute / BBRI (BE), Brussels Environment (BE), the Scientific and Technical Center of Building / CSTB (FR), Confederation of Construction (BE), Rotor (BE), Salvo (UK) and University of Brighton (UK).

The information contained in this document does not necessarily reflect the position of all the FCRBE project partners nor that of the funding authorities.

Unless explicitly stated otherwise, the content of these sheets is credited in the Creative Commons Attribution NonCommercial – Share Alike format (CCBY-NC-SA).



Unless explicitly stated, the images used in this document belong to © Rotor vzw/asbl or © Opalis. Any other image has been the subject of a systematic request for authorisation from their authors or rightful owners. When this request has not been answered, we assumed that there were no objections to the use of the image. If you feel that this interpretation is unreasonable, please let us know.



**Material description**

**By definition, a solid wood floor is an interior flooring system consisting of assembled planks and comprising a single layer of solid wood at least 2.5 mm thick.**

Within the framework of this document, we develop the specificities related to the reuse of solid wood floor elements whose original use is identical to the new intended use (i.e. *old wooden floors*). Other old wood flooring products are also available on the reclamation market but come from different applications. This is for example the case of wagon planks, barn wood planks, cheese boards or boards sawn from reclaimed beams (i.e. *old wooden floors*). Although there are some similarities between old hardwood flooring and old wooden floors, this sheet deals exclusively with the former. It also does not deal with the case of the reclamation of laminated wooden flooring, engineered wooden floors, edge strips, end-grain wooden floors and decking boards intended for outdoor use.

Old parquet floors are appreciated for their aesthetics and their reclamation is therefore frequent. Many professional suppliers have specialized in this field. Re-installation of the material can be complex if certain basic conditions are not met. In order to facilitate their reclamation, the elements generally undergo a series of preliminary operations in order to render some of their characteristics uniform. Depending on their condition, the planks may require a complete rework. These operations generally have a significant influence on the costs associated with the reclamation operation.

→ **Types.** The main types of reclaimed solid wood flooring are straight edge planks (sometimes called floor planks) and tongue and groove flooring. Pre-assembled parquet panels (Versailles parquet panels, Aremberg parquet panels, etc.) are also found but more infrequently. Mosaic parquet elements are much more rarely reclaimed.

→ **Dimensions.** Depending on the original pattern, the boards are generally characterised by the following dimensions: thickness = 10 to 30 mm, width = 70 to 300 mm, length = 0.5 to 5 m. These dimensions may vary from one batch to another as well as between several elements of the same batch.

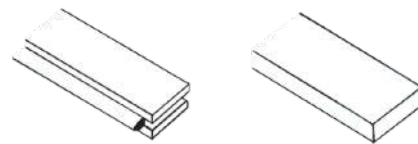

Tongue and groove planks

Straight edge planks

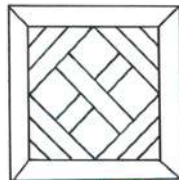

Pre-assembled parquet panel

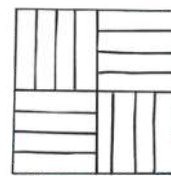

Mosaic parquet

→ **Profile.** The boards can be profiled as standard or following specific operations. Profiling can involve 2 or 4 edges and aims to give the planks a particular shape: straight edge, tongue and groove, rabbet, offset groove, with or without chamfer, with or without reduced thickness.

→ **Laying method.** The original method of laying wooden floors has a major influence on the possibilities of dismantling and recovery. Nailed floors are generally easier to recover than glued floors. In addition, the recovery of wooden floors laid with black bituminous glue dating from before the 1950s requires special measures to be taken (see box "Bitume or tar?"). In general, solid wood floors cannot be laid loose.

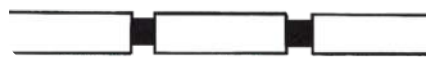

Straight edge plank



Tongue and groove planks



Tongue and groove rebate planks



Staggered tongue and groove planks



Planks with chamfer

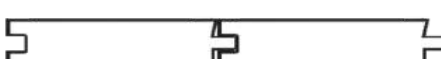

Planks with reduced thickness

→ **Species of wood.** The old batches consist mainly of deciduous wood planks (oak, chestnut, beech, hornbeam, walnut, maple, etc.) or coniferous (pine, pitch pine, fir, larch, etc.). Tropical wood species are occasionally found, especially in batches of more recent origin (teak, mahogany, iroko, jatoba, padouk, etc.).

→ **Appearance.** The appearance of a reclaimed wood flooring depends on the intrinsic characteristics of the wood (natural colour, knots, uniqueness of the wood, presence of sapwood, biological alterations, cut, grain, etc.), signs of wear (cracks, scratches, traces of paint, traces of glue on the visible face or on the installation face, holes, etc.) and operations carried out on the boards (rough-hewn, sanded, planed, sandblasted, varnished, oiled, waxed, etc.).

→ **Specific denominations.** Wooden planks generally come from all over Europe and specific denominations are common (for example: "French oak boards", "gymnasium planks", "classic London boards", etc.).



**Laminated flooring**

Laminated flooring (sometimes called sprung-floor) is made up of several layers: a solid wood cladding (wear layer) glued to an HDF (high density fibreboard) or plywood support. In general, it is machined for a floating, fast and economical installation, or a glue-down installation. The reuse of this product is possible but strongly depends on the state of the wear layer. If this is too damaged by use or by planing (previous or to be completed), the durability of the element will be compromised. A solid wood plank, on the other hand, can usually be sanded or planed several times.





**Material reclamation**

Solid wood floors are frequently found in family homes and in certain larger infrastructures (gymnasiums, exhibition halls, museums, office buildings, etc.). Often easily removable, they are good candidates for reuse, either on-site or through the professional channels of material resellers. Their interest in these items will depend essentially on the model, the quantities and the general condition of the batch.

→ *Evaluation of the potential.* An “expert eye” generally makes it possible to estimate the potential for reclamation during an on-site visit or based on photos and technical information relating to the type of wood flooring, the nature of the substrate, the installation method, quantities, dimensions, etc. A disassembly test completes this information. The focal points will be among others:

- general condition: do the boards show significant damage (moisture damage, deformation, cracks, traces of mould, traces of insects, traces of an additional coating, etc.)? What is the condition of the topcoat and wear layer? Uniformity of dimensions? What is the installation method (glued/nailed)? Are the planks easy to remove without getting damaged? Are the tongue and grooves glued? Are they weakened? Is there a risk of the presence of dangerous substances (asbestos, lead, tar, etc.)?
- the available documentation (technical sheets, declaration of performance, maintenance logs, etc.) and the assessment of the conditions of use (use of premises, traffic intensity, hygrometric conditions, variations in nuances linked to differentiated exposure, maintenance conditions, etc.).
- Commercial interest, depending on model, quantity, resale potential, ease of resizing, etc.,
- logistical arrangements, including deadlines, handling, organization of transport, etc.

Slight surface damage such as scratches, traces of paint or traces of glue can in most cases be corrected by adequate sanding/

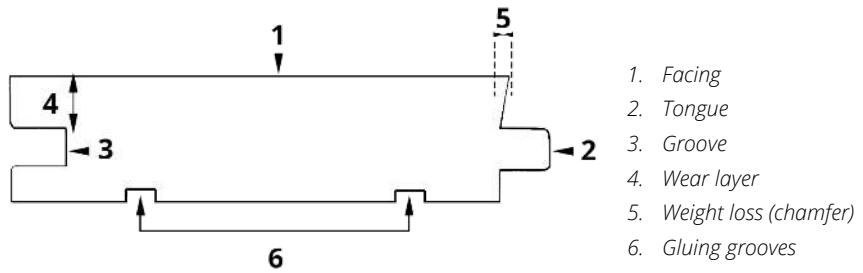

Anatomy of a tongue and groove floorboard.

planing. In general, it must be taken into account that the thickness of the wear layer after sanding/planing must be sufficient ( $\geq 2.5$  mm) to allow reclamation.

→ *Removal.* The careful dismantling of a solid wood floor must ensure the safety of workers and the integrity of the recovered elements. Particular attention must be paid to the risks linked to the presence of dangerous substances (asbestos, PAH, etc.) as well as to the risks linked to the possible presence of electrical wiring under the flooring. In a building affected by heavy work (demolition, renovations, asbestos removal, etc.), it is preferable to dismantle the wooden floors before starting this work. Otherwise, the necessary precautions must be taken to prevent them from being damaged by knocks, humidity, dirt, exposure to dangerous substances, etc.

In general, the removal depends on the original installation method. First, the skirting boards and door sills should be removed. Then, the planks are removed one by one, from one side of the room, using appropriate tools (crowbar, stripping pliers, pincers, wood chisel, etc.). The first planks are often complicated to remove without damage. In the case of tongue and groove floors, it is always advisable to start with the edge of the last row laid. The nailed floorboards are gradually raised over the entire length to the level of the nails. Particular attention will be paid to the tongue and grooves (avoid forcing, twisting or applying a lever arm at this point).

It is recommended to extract the nails from the boards when removing them using a pincer (+ wedge to avoid damaging the visible face) or a pneumatic nail punch. This step reduces the risk of deterioration of the planks during their transport and storage, and facilitates their subsequent re-working.

Traditionally, the nails are positioned in an inclined fashion at the level of the tongue, which can make their extraction difficult. The levelled nails will be more complicated to extract later.

A percentage of losses (20 to 40% of the removed surface) is generally admissible due to potential breakage and cuts.

After removal, the planks are visually sorted according to their condition (cracks, flatness, wear, condition of the grooves and tongues, presence of insects, etc.) and their characteristics (dimensions, left or right planks, etc.). Similar elements are preferably grouped, numbered and correctly identified in order to guarantee the uniformity and traceability of the batches. They are stored flat, on a pallet (no contact with the ground) and sheltered from bad weather.



Removal of a wooden floor nailed to joists

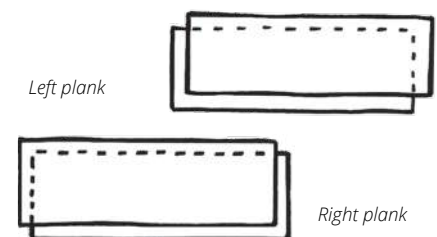

Diagram of left or right planks (tongue and groove)



→ **Operation.** Depending on their condition, solid wood floorboards may go through several operations before being re-installed. Most of the time, specialized suppliers have the necessary expertise and automatically carry out some of these operations. However, sometimes the wood is salvaged or sold in its original condition. It is then up to the buyer to anticipate the necessary steps.

- **Removal of metallic elements.** If this has not already been done during disassembly, nails, screws and other metal parts are removed using suitable tools (pliers, pneumatic nail punch). This laborious process is essential if woodworking is planned later, at the risk of damaging the machines. Using a metal detector makes it easier to locate metal objects.
- **Superficial cleaning.** By brushing, sanding or sandblasting according to requirements. Each process affects the appearance of the planks differently.
- **Cleaning of adhesive residues.** Depending on the type of glue and the ease of cleaning. This operation is carried out using manual (spatula and planer) or mechanical (planer) tools.
- **Cleaning the edges.** Often clogged by glue and varnish residues or by stubborn dirt, the edges on the right edge and the grooves/tongues are carefully cleaned using wood chisels. This is usually necessary to avoid complications during re-installation.



Tongue and Groove Cleaning Tools

- **Sawing and edging.** The planks can be cut to defined lengths and widths, or according to the requirements of the laying pattern (for example: Hungarian herringbone, herringbone, etc.). It is common for damaged ends of the planks to be cut off. It is also possible to reduce the thickness of the planks, for example to meet the requirements of underfloor heating or to remove bituminous adhesive residues.

- **Planing.** For repairing the wear layer, to remove traces of glue, or for batches with significant differences in thickness. In fact, wooden floorboards are stressed differently during their life. Typically, the centre of a living room is more stressed than its edges, which results in a more pronounced wear of the central planks. The recovered planks are then planed on one or two sides to obtain planks with a constant thickness. In this case, it is important to take into account the specific dimensions of the tongue and groove system, and to ensure that all planks are compatible for re-installation. At the end of this operation, the wear layer must have a minimum thickness of 2.5 mm to ensure good resistance over time and allow subsequent renovations.



Planing

- **Complete reworking** (dimensional calibration). In addition to being sawn and planed, the planks can be milled to rectify the tongue/groove system or to create a chamfer. Reworked planks are generally certified "ready to install".



Re-machining of tongue and groove

- **Drying.** According to the hygrometric state of the wood. The elements are generally dried naturally in a shed, taking the necessary storage arrangements (spacing between the elements, no contact with the ground, heating, ventilation, etc.). Artificial kiln drying can be used to reduce and stabilize the humidity level. Artificial drying helps eliminate potential pests (moulds, insects) and is often recommended for underfloor heating applications.

- **Repair.** Puttying or filling the holes can be carried out.
- **Finish.** Depending on the requirements, the type of original finish (oiled, varnished, waxed) and the condition of the reclaimed wooden flooring, the boards will need quite heavy sanding in order to apply the new finish (for example a formerly waxed floorboard and intended to be varnished must be sanded to bare wood otherwise stains will appear). This operation is most often carried out at the time of installation. It is advisable to turn to ecological finishing products and respect environmental and health regulations.
- **Insecticide treatment.** In case of risk of wood infestation. Infested planks should be discarded and the rest of the affected batch is preferably treated through impregnation. Several types of preventive or curative treatments exist, for example by soaking, sprinkling, brushing, autoclave, thermal, etc. They are governed by standards and recommendations for use, in particular with regard to the impregnability of wood species (see § Characteristics and fitness for use). Professional advice is recommended, especially if the wood has undergone this type of treatment before or if a topcoat is present.
- If necessary, the planks can be treated specifically to improve their reaction to fire (fireproofing).

#### Truly Reclaimed Label

As part of the European FCRBE project, to which these sheets are annexed, the organization Salvo Ltd. (UK) is working on the development of a "Truly Reclaimed" label, making it possible to certify the authentically recovered origin of materials (as opposed to artificially used materials). This label should see the light of day very soon for reclaimed wood products.





**Bitume or tar?**

It is not uncommon to find solid wood floors glued using bituminous or tarred glues. These adhesives were commonly used until the second half of the 20th century. Depending on their composition, they are likely to contain **asbestos** as well as a high content of PAHs (**Polycyclic Aromatic Hydrocarbons**). Unlike tar, bitumen contains little PAH (see table below). These toxic and carcinogenic substances are detected through samples and laboratory tests. It is recommended not to perform any disassembly before obtaining the result of these tests (asbestos inventory and HAP test).

**Wooden flooring boards with remains of tar or asbestos glue cannot be reclaimed and must be treated as hazardous waste.** As for bituminous adhesive residues, they can be removed by taking appropriate precautions (personal protective equipment, air extraction, dust removal, etc.). There are companies specialising in this operation. As the hardness and workability of bitumen is related to temperature, these operators generally prefer to plan bitumen removal in winter.

Glue type	Benzo (a) pyrene (PAH) content	Toxicity (risk)
Bitumen	<50mg/kg	Not dangerous
	> 50mg/kg	Dangerous!
Tar	> 4000 to 7000 mg/kg	Very dangerous !

For your information, there are tar-revealing sprays on the market for detecting PAH concentrations greater than 100 mg/kg.



Cleaning of bituminous adhesive residues  
© [www.parquetbitumenremoval.co.uk](http://www.parquetbitumenremoval.co.uk)

→ **Storage.** The planks are stored horizontally and stacked on pallets or in pallet boxes (for short lengths), properly strapped in and protected from external moisture. Good ventilation and a heated environment (relative humidity of the room = 40 to 65%, temperature = 20° C) make it possible to control the humidity of the wood in order to avoid subsequent deformations. Tongue-and-groove boards are preferably stored groove-to-groove. In general, it is advisable to avoid excessive overhangs, which could deform the boards under their own weight. The placement of spacers or the use of appropriately sized pallets can prevent this risk. The batches can be cellophane wrapped, taking care however to let the wood breathe.

→ **Transport and delivery.** All necessary precautions must be taken during transport and delivery (strapping, means of handling, protection against rain, loading, etc.).



Pallet-box storage



Pallet storage



Transport

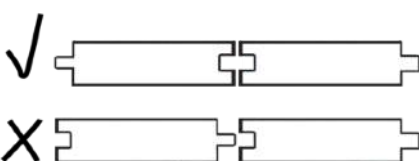

Groove-to-groove storage of tongue-and-groove boards

ÉCONOMIE CIRCULAIRE  
DES BÂTIMENTS

**Méthodologie  
de diagnostic et  
d'évaluation des  
performances  
pour le réemploi  
de parquets**

FONDATION  
BÂTIMENT  
ÉNERGIE

**Read more!**

Diagnostic and performance evaluation methodology for the re-use of parquet - Fondation Bâtiment Énergie (FBE), December 2020 (In French)  
<http://www.batiment-energie.org/doc/70/FBE-ECB-enjeu-A-parquets-v8.pdf>



**Applications and installation**

**The reimplementation of reclaimed “ready to install” solid wood floorboards is no different from that of new wood flooring. It raises the same points of attention, in particular and according to the targeted applications: choice of materials and fitness for use, installation method, properties and condition of the support, floor height, orientation of the boards and layout, thermal and acoustic insulation, fire resistance, underfloor heating, peripheral expansion joint, prevention of humidity risks, finishes, maintenance procedures, humidity and temperature condition during installation, installation times, costs, etc.**

Depending on the application, reference should be made to the European and national standards relating to the product (e.a. EN 14342), to rules of practice in force and to installation standards. According to the regulations in force, it is also necessary to take into account the thermal and acoustic requirements, protection against termites, fire resistance, etc.

Leaving some latitude on the dimensions, texture, colour of the wood and all the non-essential characteristics often makes it easier to find a batch on the reclamation market. This approach generally requires adopting more flexible design and installation strategies, which make it possible to highlight the heterogeneity of the batches while respecting the essential requirements. For example: random-width installation in free lengths or variable widths, etc. In general, it is recommended to be accompanied by a professional floor layer to assess the feasibility of the reclamation operation .

Despite their extensive knowledge of the materials and the valuable advice they can give, resellers of used solid wood flooring generally do not certify all the characteristics of the items they supply. On the other hand, some provide guarantees on aspects such as the uniformity of the batches, the dimensions of the elements, the maximum humidity level, the condition of the wood (without metal parts, mould, cracks, etc.) or even on its origin (some resellers thus affix the *FSC recycled* label which certifies that the wood comes from the dismantling of a building and

not from the cutting of trees, or the *Truly Reclaimed* label). Some suppliers are able to provide documentation on the product purchased (for more information, see the introductory sheet).

Depending on the intended use, the specifier may need to specify his expectations regarding the following characteristics:

→ *Species*. Depending on the intended use, the choice of wood species may be essential. Indeed, each species has its own characteristics, particularly in terms of sensitivity to knocks and scratches (hardness), humidity and deformation, insects and discoloration, etc. (see § *Characteristics and fitness for use*). The choice of naturally rot-resistant species (some tropical woods) should be considered for wet applications such as bathrooms.

→ *Condition*. Reclaimed solid wood floorboards may show minor alterations such as:

- traces of surface wear (nicks, cracks, holes, etc.)
- slight deformations that do not prevent installation (deflection, bending, torsion, swelling)
- slightly nicked or cut edges
- slight damage to the tongue and grooves that does not prevent re-installation
- stains, traces of paint or old finishes
- presence of nails and other metallic elements.

These deteriorations can influence the technical and aesthetic performances, as well as their reinstatement, but do not constitute a major obstacle for reuse (see § *Characteristics and fitness for use*). It is up to the designer/specifier to define the degree of imperfection tolerated, according to the defined use and the installation conditions, by specifying the degree of acceptable alterations.

Planks showing major deterioration such as significant deformation (deflection, bending, torsion, swelling), a wear layer less than 2.5 mm thick, traces of rotting and mould, heavily cracked tongue and groove, etc. must be systematically discarded. Planks with wormholes that are still active (presence of sawdust) must be treated appropriately.



*Care should be taken to ensure that there are no larvae of xylophagous insects which could spread to other wooden elements in the building. A visual inspection of the boards is recommended at the time of installation. For greater safety, it is also possible to get artificially dried planks (kiln drying process), aimed at providing an insecticidal preservation treatment or a heat treatment.*

→ *Types et dimensions*. Usually, the choice of a type of wooden floor depends on the pattern and the method of laying provided for. However, the opposite approach can also be considered: choosing the pattern and the installation method according to the possibilities offered by a batch of available wood floorboards! In general, the thickness of the boards must be uniform, particularly in the case of tongue and groove systems. Random-width flooring patterns allow greater flexibility in terms of width and length. Conversely, the herringbone and Hungarian herringbone patterns are more demanding. One solution may be to get precise dimensional characteristics or to provide for a transformation of the material (planing, edging, machining, etc.).





→ **Humidity.** In general, to avoid deformation of the wood due to moisture (movements, swelling, cracks, etc.), a maximum wood humidity level of  $10 \pm 3\%$  is recommended for installation. Many suppliers are able to meet this requirement. If necessary, this parameter can be measured using a moisture meter. Additional precautions are recommended to avoid variations in relative humidity and temperature during and after installation: acclimatization of the batch to ambient air, control of the humidity of the substrate, waterproof underlay, additional precautions for underfloor heating, etc.

→ **Finish.** According to the defined requirements: raw, brushed, sanded, planed, varnished, oiled, waxed, etc. If a new topcoat is applied, by the supplier or on site, it is recommended to use products that respect the environment and the quality of indoor air.

→ **Toxicity.** For indoor use, care should be taken to ensure that the wood has not been treated or exposed to toxic substances during its previous use, particularly if the application is likely to involve contact with humans/animals and/or food. In the absence of information on this subject, it is best to stick to the "precautionary principle" (see § *Characteristics and fitness for use*).

→ **Quantities.** It is important to purchase a sufficient quantity of planks from the outset. As each batch has unique aesthetic characteristics, it is not certain that an identical model will still be available with a subsequent order. In general, it is advisable to order a surplus of 10 to 15% depending on the condition of the batch and the design strategy chosen (up to 25% for heterogeneous batches). To increase the chances of meeting the offer available on the reclaimed market, the designer/specifier can choose to split the batch with different models.

→ **Laying pattern.** There is a very wide variety of laying patterns. Opting for a pattern identical to the original one is a good way to avoid too much change in the boards. In some cases, more substantial machining can allow a successful reclamation operation (for example, a broken batten flooring transformed into a Hungarian herringbone flooring by sawing off the damaged corners). Some professional suppliers are also able to offer a layout assistance service. Examples of patterns:

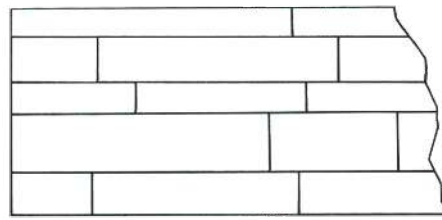

Free length and random-width flooring

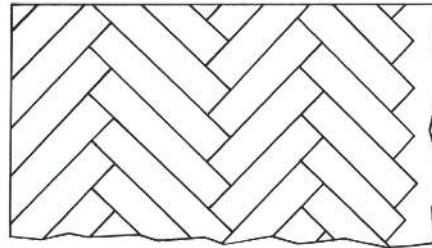

Herringbone flooring

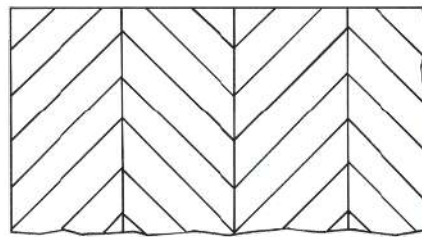

Hungarian herringbone flooring

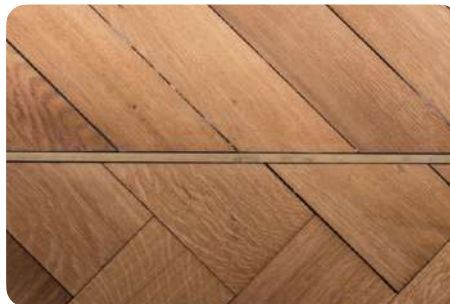

Assembly details of different batches. (left) MAMOUT architecten & Atelier d'architecture AUXAU / Huis Renier-Chalon (BE) © Guy-Joël Olivier, (right) Librebook © ROTOR

**Design tip!**

To increase the chances of meeting the offer available on the reclamation market, the designer/specifier can choose to accept several different batches and distribute them in an organised manner in the building. For example, by providing a uniform batch for each separate space, or by ensuring elegant junctions when combining several batches. These design strategies generally result in interesting architectural qualities. They must be anticipated and be the subject of in-depth studies, in particular to ensure that the batches are compatible with each other.

→ **Fixing method and reversibility.** When the intended application allows it, nailed installation is to be preferred to glued installation, the latter possibly compromising future reclamation.

→ **Underfloor heating.** The combination of underfloor heating and solid wood flooring is not always easy. It is recommended to call in a specialist to determine the specific requirements of this system: wood species and suitable thickness, wood stability, relative humidity and drying of the boards, slenderness ratio of the boards, etc.

→ **Fire performance.** The reaction to fire class can be determined with regard to the type of wood and the thickness of the boards. Certain flame retardant treatments make it possible to improve this characteristic.



**Characteristics and fitness for use**

The reuse of reclaimed solid wood flooring generally requires mastering certain characteristics that allow compliance with the requirements relating to the intended application. The main characteristics, defined in particular in the harmonized standard EN 14342 (relating to new products) or in the installation standards, can for the most part be evaluated by professional flooring specialists. For your information, they are listed in Table 2.

In general, each species of wood can be characterised by a series of parameters relating to the expected level of performance. It is imperative to take this into account for more demanding applications. For the most common species of reclaimed solid wood flooring, table 1 shows some of these parameters relevant for flooring applications. Other parameters may be required as need be. It is relatively easy to find this additional information but also for other less common species (elm, walnut, etc.).

Table 1 : Characteristics of the most common types of wood in reclaimed solid wood flooring

	Density [kg/m <sup>3</sup> ]	Monnin / Janka hardness (1)	Stability in use (2)	Sensitivity to insects (3)	Impregnability class (4)
European oak <i>Quercus robur</i>	740	4,2 / 6049 N (mid-hard)	moderate	No/Yes	4
Chestnut <i>Castanea sativa</i>	640	2,9 / 3070 N (soft)	moderate	No/Yes	4
European maple <i>Acer spp.</i>	600	4,7 / 4850 N (mid-hard)	moderate	Yes/Yes	1
Beech <i>Fagus sylvatica</i>	710	4,2 / 7060 N (mid-hard)	moderate	No/No	1
Scots pine <i>Pinus sylvestris</i>	550	2,6 / 2940 N (soft)	moderate	No/No	3-4
Pitch pine <i>Pinus caribaea</i>	580	3,5 / 5000 N (mid-hard)	low	No/No	3-4
Fir/Spruce <i>Picea abies</i>	450	2,5 / 1910 N (soft)	moderate	No/No	3-4
Teak <i>Tectona grandis</i>	670	4,2 / 4450 N (mid-hard)	moderate	No/Yes	4

- (1) There are various methods for determining the hardness of wood, with different test arrangements (e.g. Monnin, Janka, Brinnell). The values below, taken from different sources, are given as an indication. They show the transversal sinking resistance at 12% Humidity. These are indicative data's because variations exist depending on the growing conditions of the trees.
- (2) Ability of wood not to warp under the influence of variations in humidity and temperature.
- (3) Heartwood/Sapwood - susceptibility to *Lyctus* attacks.
- (4) Only for heartwood, 1 = Impregnable -> 4 = Non-impregnable.

Wood species with a high density are generally harder. This is also accompanied, in most cases, by better resistance to wear and puncture. In traditional architecture, resinous species, less dense, such as pine or spruce, were often reserved for less stressed spaces (bedrooms, attics, etc.). Today, these species are often less expensive than deciduous trees or tropical species.



Reclamation of 50 m<sup>2</sup> of broken-batten floorboards. The planks were sawn through to remove the old bitumen glue. They were then reworked in order to be re-installed (glued installation) with a Hungarian herringbone pattern, Boom (BE) © Atelier Passe Partout





Table 2: Relevant characteristics (depending on the context) for the evaluation of the fitness for the use of reclaimed solid wood floors.

Characteristics	Comments
<b>Species</b>	The identification of the wood species is generally essential for the evaluation of the performance of a wood floor. This characteristic can be determined by professional suppliers or in the laboratory.
<b>Hardness</b>	The hardness of a wood species determines its resistance to fracture (see Table 1). It is essentially a function of the density of the species considered and the arrangement of the fibres. It is commonly expressed on a scale from 1 to 10 (Monnin hardness) or [N] (Janka hardness) or [N/mm <sup>2</sup> ] (Brinell hardness). This parameter must be considered with regard to the envisaged application. In general, “harder” species are more suitable for high stress applications (entrance hall, retail space, etc.).
<b>Wood stability</b>	This performance characterizes the way in which wood behaves when subjected to significant variations in humidity or temperature (see table 1). This notion integrates the importance of deformations (“wood movement”) and the speed at which they take place. A stable wood species is likely to be more suitable for applications subject to large variations in humidity (e.g. bathrooms). Design and installation details are also to be considered (type of wood floor, installation method, dimensions, etc.)
<b>Use category</b>	The use category of new wooden floors is often determined with regard to the hardness of the species and the thickness of the surface of the boards (wear layer) (French standard XP B 53-669 or EN ISO 10874). In the case of reclaimed solid wood floors, it is relevant to refer to these standards, provided that the type of wood can be determined with precision and that the thickness of the residual wear layer takes account of the sanding/planing operations.
<b>Surface quality</b>	In some cases, aesthetic requirements may be given on the appearance of the wood and the admissible defects of the surface. These requirements should be detailed based on general criteria (presence of stains and holes, traces of paint, wood finish, etc.) or specific to the wood species considered (percentage of knots, variation in colour, presence of healthy sapwood, cracks, pockets of resin, variations in the slope of the grain, etc.). Whether a batch meets these requirements depends on many factors. Leaving some latitude on these non-essential characteristics (as long as they do not affect the solidity and wear resistance of the flooring) often makes it easier to find a batch on the reclamation market.
<b>Plank sizes and profiling system</b>	The dimensional characteristics are closely linked to the degree of sorting or to the operations carried out on the reclaimed solid wood floorboards. Depending on the type of floorboard, the laying method and the intended pattern, permissible deviations are to be considered. In general, completely reworked planks meet these requirements more easily. A visual or detailed examination of the batch is often sufficient to estimate these characteristics.  It should be ensured that the thickness of the boards corresponds to the intended use. The thickness of the wear layer must be greater than 2.5 mm.
<b>Geometric characteristics and acceptable deformations</b>	The requirements related to the straightness of the edges, the angularity, the flatness of the surface, the bending, the sagging or the warping of the boards are defined with regard to the type of flooring, the method of laying and the planned pattern. These characteristics are closely linked to the degree of sorting or to the operations carried out on the reclaimed solid wood floorboards. In general, completely reworked planks meet these requirements more easily. A visual or detailed examination of the batch is often sufficient to estimate these characteristics.
<b>Humidity level</b>	To avoid subsequent deformation, solid wood parquet boards must be installed at a balanced humidity level defined according to the application ( $H = 10 \pm 3\%$ ). This parameter essentially depends on the drying and storage conditions of the wood. A check can be carried out by using a moisture meter.
<b>Flexural strength and rigidity</b>	These characteristics are relevant to evaluate for self-supporting solid wood floors or for specific applications (e.g.: sports hall).



Characteristics	Comments
<b>Wear resistance</b>	<p>The wear resistance of a wooden floor is evaluated with regard to the wood species used and the type of finish (for example, a varnished finish in 3 coats greatly improves the wear resistance). In general, dense woods (see Table 1) are less susceptible to wear. Assessment of this performance is particularly relevant for applications subject to intense traffic or likely to be exposed to large quantities of abrasive particles (entrance hall, etc.). A test assessment using a Taber abraser is possible (EN 13696).</p>
<b>Puncture resistance</b>	<p>This characteristic is assessed according to the intended use (for example: presence of heavy furniture, flimsy surface of the support points, etc.) and the hardness of the wood species. In general, dense woods (see Table 1) are harder and less sensitive to puncturing. A test assessment is possible (Brinell hardness measurement, EN 1534).</p>
<b>Slippage</b>	<p>The slip resistance of a wooden floor is evaluated with regard to the intrinsic characteristics of the material (grain, type of finish, etc.) as well as by its conditions of use (presence of water or particles, frequency of traffic and wear, maintenance, etc.). This characteristic is therefore likely to change over time. Its determination can be made by laboratory or on-site test measurements (SRT pendulum test).</p>
<b>Reaction to fire</b>	<p>Specific requirements for the reaction to fire of coatings are determined by national regulations. These requirements depend, among other things, on the use of the premises (for example: private or community housing, emergency exits, etc.), on the height of the building, as well as by the ability of users to evacuate the premises in the event of fire (senior citizens' residence, hospital, etc.).</p> <p>The reaction to fire of construction products is defined by European standard EN 13501-1 (Euroclass) and is assessed in particular on the basis of a test carried out under the final application conditions, i.e. taking into account the entire construction system (support + underlay + wood floor + finish).</p> <p>In the case of solid wood floors, it is possible to assess the reaction to fire class without prior testing, through a series of predefined combinations, which take into account the type of floorboard, the wood species (density), minimum thickness and installation conditions (for more information, refer to standard EN 14342).</p> <p>It is therefore important for the designer/specifier to meet regulatory requirements in terms of reaction to fire by determining the materials and their method of implementation, with regard to the intended use.</p> <p>To a certain extent, it is conceivable to subject the floorboards to a fire retardant treatment which makes it possible to improve the reaction to fire and reduce the contribution to conflagration and the propagation of a fire. It is necessary to ensure the compatibility of the boards with existing solutions (impregnation, film-forming finish, varnish, etc.), in particular with regard to the impregnability characteristics of the wood.</p>
<b>Thermal properties</b>	<p>The insulating properties of a wooden floor depend essentially on the type of wood and its thickness. The higher the density, the less insulating the floorboard. Tabulated values are used to calculate the thermal resistance of solid wood floors with regard to the type of wood and its thickness as well as the characteristics of the support and the underlay used. This performance assessment is particularly important in the case of underfloor or reversible heating.</p>
<b>Acoustic properties</b>	<p>Generally speaking, solid wood floors as such are not good sound insulators. The acoustic performance of a floor covering must be assessed taking into account the underlay and the support (for example: soundproofing screed, acoustic underlay, etc.).</p>
<b>Toxicité</b>	<p>Solid wood floorboards may have been treated with toxic products or have been in contact during their use with dangerous substances (for example: lead, asbestos, tar, PCP, etc.). Most of the time, even if it is possible to visually detect the presence or absence of traces of glues, preservative and finishing treatments, it is generally more complicated to determine the substances present. Laboratory tests may be required to assess the dangerousness of the contaminants present. A complete rework of the boards and/or the application of a film-forming finish (for example: vitrifying varnish) may be a solution. In the absence of information on this subject, it is best to stick to the "precautionary principle" or likely to interact with people, for interior applications. In general, it is advisable to turn to ecological finishing products and to respect environmental and health regulations.</p>



Assessing the impact of reclaimed timber construction products on global warming is complex and difficult to generalize. The general principle is that construction timber can confine biogenic carbon. Reclamation is therefore a way of preserving these carbon stocks and preventing it from being released into the atmosphere (which would be the case if the wood was incinerated, for example). The overall environmental assessment of a reclaimed wooden element must, however, also take into account aspects such as the origin of the product and the distance travelled, the use of preservation treatment, etc. For more information, it is advisable to consult the specific paragraph devoted to this question in the introductory sheet.

**Availability**

The availability of reclaimed solid wood floors depends on the quantities required. As an indication, for uniform batches:

Frequent	0 → 50m <sup>2</sup>
Occasional	50 → 100m <sup>2</sup>
Rare	100 → 250m <sup>2</sup>

**Indicative prices (Excl. tax)**

A non-exhaustive sampling of the reclamation market in North West Europe (Belgium, France, Great Britain and the Netherlands) made it possible to extract some indicative prices. These vary according to the origin, the history, the dimensions, the patina, the quantities or the degree of preparation of the planks. Softwood (pine, spruce) flooring is generally less expensive than hardwood (oak, chestnut, beech, tropical species, etc.) but does not have the same properties.

Some observed prices for private customers :

- Oak flooring (planks): 40 to 150 €/m<sup>2</sup>
- Pine flooring (planks): 10 to 50 €/m<sup>2</sup>
- Oak parquet (panels): > 160 €/m<sup>2</sup>
- Sports hall parquet: 50 to 100 €/m<sup>2</sup>

Depending on the condition of the original floorboards, several preparatory stages of the product for installation may be required. These steps are often necessary to allow an efficient and smooth installation. The cost generated can vary between 25 to 100 €/m<sup>2</sup>. Wanting to save money by buying an unprepared product is therefore not always a good idea, unless you have the necessary time, skills and tools!



Reclamation of 80 m<sup>2</sup> of oak floorboards, herringbone pattern, Librebook bookstore, Brussels (BE) © Rotor



Reclamation of 290 m<sup>2</sup> of oak floorboards, herringbone pattern, private project, Brussels (BE) © K2A architectes, Oana Crainic.

**For more information!**

Product sheet-application: solid wood floors for re-use as indoor flooring. The Brussels Building: Source of new Materials (BBSM). May 2021. (In French).

[https://www.bbsm.brussels/wp-content/uploads/2021/06/annexe-21-WP6\\_fiche-produit-application-parquet-en-bois-massif-de-reemploi-revetement-interieur.pdf](https://www.bbsm.brussels/wp-content/uploads/2021/06/annexe-21-WP6_fiche-produit-application-parquet-en-bois-massif-de-reemploi-revetement-interieur.pdf)



**Find specialised businesses**

**SALVO** **OPALIS**

salvoweb.com opalis.eu





[salvoweb.com](http://salvoweb.com) [opalis.eu](http://opalis.eu)



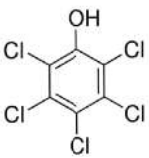

**Hazardous substances and precautions**

Reclaimed solid wood floors may have been treated with toxic products or have been in contact with hazardous substances during their use. Most of the time, even if it is possible to visually detect the presence or absence of preservative and finishing treatments, it is generally more complicated to determine the exact nature of the substances present. Lead, asbestos, Polycyclic Aromatic Hydrocarbons (PAHs) and Pentachlorophenols (PCP) are among the hazardous substances likely to be encountered in reclaimed parquet boards. Their concentration in wood, their effectiveness and their residual harmful power are difficult to estimate without implementing specific laboratory tests. In the absence of information on this subject, it is best to stick to the “precautionary principle” or likely to come into direct contact with people for interior applications. In addition, sawing, planing, sanding, etc. must be carried out by taking the appropriate safety measures (personal protective equipment, dust extraction systems, waste disposal, etc.).

	<p>A <i>lead</i> diagnosis may be necessary to detect the presence of old lead paints on wooden floorboards. This diagnosis can be carried out either using a commercially available lead test kit, or by sending a sample of the paint to the laboratory or by having this test carried out by a professional. If the presence of lead is proven, it is strongly recommended to strip using a specialized operator. It is strongly advised against using a heat gun, sander or sandpaper to remove lead paint. Chemical stripping will be preferred, with adequate health and environmental provisions. An alternative to stripping can be to apply a new top coat so that the old coat of paint is completely encapsulated.</p>
	<p>Reclaimed wood floorboards may be contaminated with <i>asbestos</i> present in old, bituminous or tarred wood adhesives (see specific box) or old resilient flooring adhesives (if the flooring has been covered with vinyl by example). Contamination can also come from dust resulting from poorly carried out asbestos removal work. It is therefore advisable, as far as possible, to remove the floorboards before the asbestos removal work or to ensure that all protective precautions are taken if this work is carried out before removal. In all cases, inquire about the asbestos diagnosis if available.</p>
	<p>The contamination of wooden floorboards by <i>PAHs</i> is mainly due to the presence of old bituminous or tarred adhesives (see specific box).</p>
	<p><i>Pentachlorophenol (PCP)</i>. The use of this wood treatment agent (pesticide) has been regulated in Europe since the 1990s. However, there is a low risk of finding this persistent, toxic and endocrine disrupting pollutant in reclaimed solid wood floors. It is a substance which can be carcinogenic in high doses. The absence of direct contact with the material or the application of a film-forming finish (for example: vitrifying varnish) makes it possible to limit the risk.</p>
	<p>For more information, see the following document written by INRS which summarises the main wood treatment products (constituents, hazards, uses, preventive measures): <a href="https://www.inrs.fr/media.html?refINRS=ED%20981">https://www.inrs.fr/media.html?refINRS=ED%20981</a> (in French).</p>

**Disclaimer**

This sheet is intended for designers, specifiers and other members of construction project teams wishing to reuse this building material or product. It is part of a collection of sheets aimed at bringing together the available information to date that is likely to facilitate the reuse of building materials and products.

This sheet has been produced by Rotor vzw/asbl within the framework of the Interreg FCRBE project - Facilitating the Circulation of Reclaimed Building Elements, supported by the entire project partnership. Sources of information include the experience of reclamation dealers and involved project partners, lessons learned from exemplary projects, available technical documentation, etc.

The sheets have been produced between 2019 and 2021. As the reclamation sector is evolving, some information, notably regarding pricing and availability, may change over the time. When the text refers to European standards, it is up to the project team to refer, if necessary, to their national implementations and local specificities.

It is important to note that the information presented here is not exhaustive or intended to replace the expertise of professionals. Specific questions are always project related and should be treated as such.

The complete collection of sheets (including the introductory sheet) is freely available from different reference websites (a.o. [opalis.eu](http://opalis.eu), [nweurope.eu/fcrbe](http://nweurope.eu/fcrbe), [futureuse.co.uk](http://futureuse.co.uk)).

Non-exhaustive directories of dealers in reclaimed building materials are available on [www.opalis.eu](http://www.opalis.eu) and [www.salvoweb.com](http://www.salvoweb.com).

---

Interreg FCRBE partnership: Bellastock (FR), the Belgian Building Research Institute / BBRI (BE), Brussels Environment (BE), the Scientific and Technical Center of Building / CSTB (FR), Confederation of Construction (BE), Rotor (BE), Salvo (UK) and University of Brighton (UK).

The information contained in this document does not necessarily reflect the position of all the FCRBE project partners nor that of the funding authorities.

Unless explicitly stated otherwise, the content of these sheets is credited in the Creative Commons Attribution NonCommercial – Share Alike format (CCBY-NC-SA).



Unless explicitly stated, the images used in this document belong to © Rotor vzw/asbl or © Opalis. Any other image has been the subject of a systematic request for authorisation from their authors or rightful owners. When this request has not been answered, we assumed that there were no objections to the use of the image. If you feel that this interpretation is unreasonable, please let us know.



**Product description**

**Raised access floor systems, also called “false floors” or “raised floors”, are designed from regular sized modular coverings, placed on a substrate made up of fixed pedestals or height-adjustable jacks (self-supporting floor) that can be connected to each other by reinforcing crossbars (cross-braced floor). The technical void between the ground and the raised floor (= plenum) allows the routing of cable networks (electrical, IT, telecommunications) and piping for heating, air conditioning and ventilation networks.**

Unlike hollow floor systems, which are not the subject of this sheet, modular coverings are removable, interchangeable and allow easy access to the plenum. This light-weight design promotes flexibility in the layout of the premises and facilitates the reclamation of elements. Most of the time, only the coverings are reused. Their re-installation then requires the use of a substrate of compatible new elements. Due to their structural character, it is often necessary to properly assess the technical performance of reclaimed raised floors, in order to ensure their fitness for use. Particular attention should therefore be paid to the traceability and uniformity of the recovered batches. To our knowledge, the sector is currently under-developed, but significant progress has been made in recent years.

→ **Types.** Reclaimed coverings are mainly made of a core of high density fibreboard (HDF) or calcium sulphate (gypsum) reinforced with fibres. Depending on the model, they are fully or partially encapsulated in an aluminium or galvanised steel sheet. The

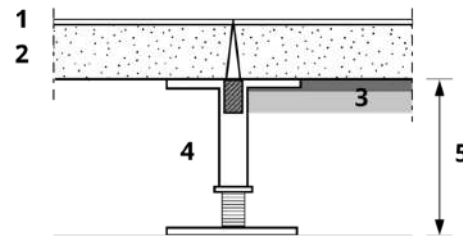

Anatomy of a raised access floor

upper face (visible face) is raw (uncoated) or covered with a factory finish (see finish). The edges are protected by the folded sheet or by self-extinguishing and antistatic PVC strips.

→ **Formats.** The dimensions of the coverings are generally 500 mm × 500 mm or 600 mm × 600 mm and their thickness is in the order of 16 mm to 44 mm. Most of the time, the edges are chamfered to facilitate installation and removal.

→ **Finish.** The upper face of the coverings can be provided with a factory finish (laminated, PVC, vinyl, carpet, linoleum, rubber, etc.) or be uncoated, i.e. designed to receive a cladding finish after their installation. In the case of reclaimed coverings, there may be traces of glue. The type of finish is a major contributor to the performance of the coverings and raised flooring system.

→ **Jacks and crosspieces.** Rarely reclaimed, these substrate elements are generally made of galvanised steel. The jacks consist of a threaded rod (+ nut) allowing height adjustment, a base plate ensuring fixing to the ground and a support head fitted with steel, aluminium or synthetic lugs, and serving as a support for the floor coverings. Certain models of jacks include a device intended for the attachment of an earthing strap.

1. Coating
2. Covering (with chamfered edge)
3. Crosspiece (optional)
4. Adjustable jack
5. Plenum



Incomplete covering, uncoated, based on chipboard, encapsulated in a galvanised steel sheet. Half of the edge is provided with a self-extinguishing PVC strip.

The crosspieces must be compatible with the jack model and are either clipped or screwed to them. They reinforce the stability of the system by distributing the horizontal forces and contribute to waterproofing when they are provided with a PVC top cladding.

→ **Accessories.** Many specific accessories generally accompany raised floor systems and can occasionally be reclaimed. These are elements integrated into the coverings (for example: connection boxes, cable glands, ventilation grilles, perforated coverings, etc.) or separate (for example: specific structural elements, closing cheeks, steps, risers, guard-rails, etc.).

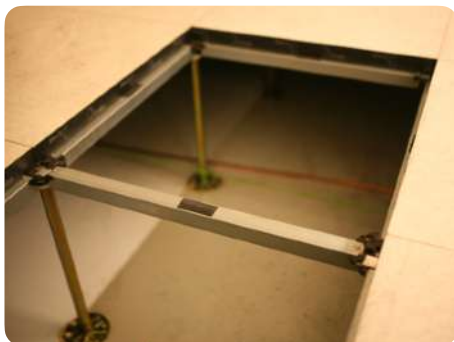

Raised floor with braced framework. Laminate coated coverings.



Self-supporting raised floor. Agglomerated wood-based coverings, with a textile covering (carpet tiles).



Covering with factory finish (textile). 2% chamfered edge.





**Product reclamation**

**Raised floors are often found in buildings housing technical installations and/or requiring a certain flexibility in terms of layout (office buildings, computer rooms, hospitals, museums, etc.). Often easily removable, they are good candidates for reclamation, either on-site or through the professional channels of products resellers. Their interest in these items will depend essentially on the model, the quantities and the general condition of the batch.**

→ *Evaluation of potential.* An "expert eye" generally makes it possible to estimate the potential for reclamation during an on-site visit or based on photos and technical information relating to the model, manufacturer, quantities, dimensions, etc. The points of attention are among others:

- general condition: do the coverings have a factory finish? If so, what is its state of wear? Is the cladding layer glued? Is it easy to remove? Are fibreboard coverings warped due to excess moisture? Do the metallic parts show traces of corrosion? Do we suspect a significant residual deflection that could call into question their reclamation?
- the available documentation (technical sheets, declaration of performance, etc.) and the assessment of the conditions of use.
- Commercial interest, depending on model, quantity, resale potential, ease of maintenance, etc.;
- logistical arrangements, including deadlines, handling, organisation of transport, etc.

→ *Removal.* Careful dismantling should aim to ensure the integrity of the coverings and workers' safety. After having removed all the surface elements of the floor, and proceeded to de-energise the electrical networks connected to the floor, it is advisable, if necessary, to remove the finishing cladding. The accessories (cable glands, ventilation grilles, connection boxes, etc.) must be carefully removed if their reclamation is envisaged.

In order to guarantee the uniformity of the batches, it is advisable not to mix the various covering models, and to carry out if necessary a separation of similar elements if their original application differs. Self-checking procedures can be put in place during removal.

The coverings are generally removed using a suction cup. The use of screwdrivers or any other blunt tool is to be avoided. For the safety of the workers, it is preferable to proceed with the simultaneous dismantling of the jacks and the crosspieces. Once dismantled, the coverings are sorted by type and format, and deformed or doubtful-looking elements are discarded. Incomplete coverings (edging coverings or those that have been cut) can be recovered separately and correctly identified.

The coverings are stacked horizontally on pallets (avoiding spillover) and strapped or banded. The number of stacked coverings will be determined according to their specific mass (generally 10 to 15 kg/covering depending on the model), the stability of the pallets and the load capacity of the evacuation exits. As far as possible, it is advisable not to walk with heavy loads on the floor to be dismantled.

In some cases, it is preferable to insert spacers between the coverings to prevent them from sticking together. It is strongly recommended to label each pallet at the time of removal to ensure product traceability.

**Marking**

*Coverings often have a reference on the underside or on the edge. This reference can be used to find the product sheet and obtain information relating to the date of manufacture, the load resistance class and the fire resistance class at the time of the initial installation.*



*Residual glue on the upper face of the coverings.*



*Deformed or non-compliant coverings, not recovered.*

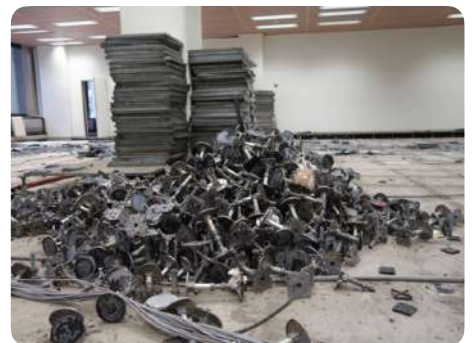

*Jacks not recovered, significant glue residue.*



*Removal of the coverings using a suction cup*



→ **Treatments.** To be laid without complications, the coverings must be cleaned of the remains of glue on the surface and on the edges. This operation is generally carried out in the workshop, manually and using an industrial belt sander. Coverings with a steel edge are also checked and stapled if necessary. Once cleaned, the coverings are again stored on a pallet, strapped or banded, protected through shrink wrapping and labelled.

→ **Performance evaluation.** Given the possibility of coming across batches of large uniform surfaces, batches of floor coverings are one of the rare reclamation products that can be accompanied by a performance certification (for example: admissible load class, deflection class, reaction to fire, acoustic performance). In this case, the professional operator calls on a laboratory or a certified body to establish representative sampling and carry out characterisation tests.

→ **Storage.** It is recommended to store the floor coverings at room temperature (15° C to 25° C), away from humidity and dust (recommended relative air humidity from 40 to 65%). Metal components and particle boards are particularly sensitive to variations in humidity.

→ **Transport and delivery.** The necessary precautions must be taken during transport and delivery in order to minimise breakage (strapped, shrink wrapped pallet, etc.).

It is advisable to involve specialised professionals to ensure the smooth running of these operations.

*"[...] Large-scale development projects that are accompanied by a demand for large quantities of recovered products are an excellent way to strengthen and expand the existing reclamation market. In some cases, a large-scale operation can help support new investments in research and development, machinery and services. It can even lead to the creation of a new business. The Pulse project, in the Paris region, is the perfect example. A unique demand for 22,000 m<sup>2</sup> of recovered technical flooring has enabled the company Mobius to develop a new business model around this product, which was rare on the reclamation market until then. In response to this demand, the company has extended its services in relation to these materials. They now offer their customers product guarantees and carbon footprint assessments."*

*[Excerpt from A Guide to Identifying the Reclamation Potential of Construction Products] FCRBE.*



Storage of coverings to be cleaned © [Mobius](#) - Marie Moroté



Cleaning uncoated coverings © [Mobius](#) - Marie Moroté





### Applications and laying

**Reclaimed raised floor coverings can be used for applications subject to moderate stress (office) or more intense (laboratories, computer server rooms, etc.). The choice of coverings and substrate parts must, however, take into account the expected stresses ( see “characteristics and fitness for use” below ). In all cases, reference should be made to the usage standards (EN 12825:2013) and to the state of the art in force (or implementation standards).**

The implementation of fully sorted and cleaned reclaimed raised flooring is no different from that of new flooring. It raises the same points of attention, in particular: choice of materials (coverings, substrate, finishing cladding, specific accessories, etc.), method of laying the finishing cladding (laid or glued), properties and condition of the support, floor height, layout and fixing of the jacks (using anti-vibration glue, screwing or welding), thermal and acoustic insulation, fire resistance and, compartmentalisation, airtightness, protection against electric shock and overcurrent, expansion joints, reinforcements and tie rods, diagonal crosspieces in seismic regions, peripheral profiles and precautions, horizontality and flatness of the floor, prevention of humidity risks, minimum ceiling height, maintenance procedures, installation lead times, costs, etc.

To facilitate laying, the specifier will take care to use batches with a certain degree of uniformity in terms of the following characteristics:

→ **Batch composition.** The batch must consist of panels of the same type and same format. Ideally, coverings from the same batch have the same origin, which to some extent ensures that they have been subjected to similar loads.

→ **Appearance.** Slight variations in colour are possible for factory coated coverings (e.g. carpet covered coverings). These variations are mainly due to the original exposure and use. It is therefore advisable to mix the coverings when laying.

→ **Condition.** Reclaimed coverings may show signs of deterioration such as signs of surface wear, stains, knocks. In the case of uncoated coverings, these aspects will generally be camouflaged by the application of a finishing cladding.

→ **Declared performances.** In the case of split batches, it should be ensured that the declared performance is similar and compatible with the requirements needed.

→ **Quantity.** Some suppliers may include surplus when the product is delivered if they are not able to guarantee the absolute uniformity of the characteristics mentioned above. This surplus can also be applied in the case of an on-site salvage scenario. It is also advisable to provide a surplus of coverings for subsequent replacement and repairs.

Most professional suppliers are able to ensure that delivered batches meet these requirements.

#### Design tip!

*To increase the chances of meeting the offer available on the reclamation market, the specifier can choose to accept several different batches and distribute them in an organised manner in the building. For example, plan a uniform batch of raised floor coverings per space or per floor.*

#### Think reversible!

*For equivalent performances, the choice of a flexible cladding such as carpet tile/PVC non-adhesive or not glued is preferable. Easier to remove, it promotes the reclamation of unclad floor coverings.*



Re-installation of raised floor coverings and new jacks (FR). © Mobius - Marie Moroté



Re-installation of raised floor coverings and new jacks (FR). © Mobius - Marie Moroté





**Characteristics and fitness for use**

To date, there is no harmonised European standard that deals with raised floors. However, the national standards in force (NBN EN 12825 in Belgium, NF EN 12825 + NF EN 1366-6 + NF DTU 57.1 in France, PSA MOB PF2 / SPU and BS EN 12825 in the United Kingdom, NEN EN 12825 + NEN EN 1366-6 in the Netherlands) establish the relevant characteristics (depending on the context) in order to determine their fitness for use. Although detailed for new products, these characteristics may prove useful in considering the specific case of reclaimed raised flooring.

It should be emphasised that a raised floor should be seen as a *system* of separate elements (coverings, jacks, crosspieces, cladding, etc.) whose individual performance contributes to the overall performance of the system. As such, the performance of the finishing cladding (not detailed here) is just as decisive in meeting the desired requirements (see specific sheet on carpet tiles).

Depending on the requirement level and the floor area to be reclaimed, the use of laboratory tests is a relevant option to determine the essential performance of reclaimed raised floors. This assessment is interesting for the reclamation of batches on site or from external sources. In addition, some professional dealers are able to provide a series of certified performances accompanying batches of uniform coverings (for example: load class, deflection class, reaction to fire, acoustic tests, etc.).

The use of the original technical data can also be considered for elements not exceeding the reference lifespan (generally 25 years for fibre-board coverings). However, uncertainties may remain as to the evolution of their performance over time and as to non-compliance with usage requirements, which may adversely affect the performance of the original product.

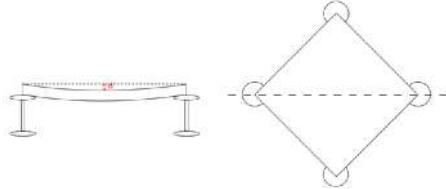
Characteristics	Comments
<b>Maximum permissible load</b>	This parameter determines the maximum load that can be supported by the coverings at a given floor height. It can be determined by measuring the breaking load by means of destructive tests on a sample (according to standard EN 12825). The result is expressed in kN and is necessarily greater than 4 kN. The maximum admissible load is then equivalent to the measured breaking load divided by a safety factor (2 or 3). The jacks must withstand 4 times the maximum allowable load.
<b>Deflection</b>	This characteristic describes the deformation (flexibility) of the covering under maximum admissible load. It can be determined in the laboratory, according to standard EN 12825. The most severe deflection class A corresponds to a maximum deflection of 2.5 mm. The residual deflection after 30 minutes should not exceed 0.5 mm. Coverings fully encapsulated by galvanised sheet steel are generally more rigid. Hard cladding strongly influences this parameter. When assessing a batch potential, it is advisable to estimate by sampling the residual deflection of the coverings.  
<b>Reaction to fire</b>	Specific requirements for the reaction to fire of claddings are determined by national regulations. These requirements depend, among other things, on the use of the premises (for example: private or community housing, emergency exits, terraces on flat roofs, etc.), on the height of the building (for the façade cladding) but also on the ability of users to evacuate the premises in the event of fire (senior citizens' residence, hospital, etc.).  Classification of construction products according to reaction to fire is defined by European standard EN 13501- 1 (Euroclass) and is assessed in particular on the basis of a test carried out under the final application conditions, i.e. taking into account the entire raised flooring system. For example, coverings made from mineral materials (e.g. calcium sulphate) are most of the time classified A1 <sub>fl</sub> or A2 <sub>fl</sub> (incombustible) and those based on agglomerated wood particles are generally classified B <sub>fl</sub> (low combustibility).
<b>Fire resistance</b>	At a European level, the classification of the fire resistance of different building elements is described in standard EN 13501-2. It is expressed by a period of time R <sub>f</sub> (in minutes) during which a construction system satisfies the criteria of stability (R), flame tightness (E) and thermal insulation (I). Its application to raised floors leads to one of the following classifications: R 15, R 30, RE 30 or REI 30. The EN 1366-6 test standard is used to determine the fire resistance of raised floors. Coverings entirely encapsulated by galvanised steel sheet or in mineral matter generally have a higher fire resistance than coverings made of partially encapsulated agglomerated wood particles.



Characteristics	Comments
<b>Electrostatic behaviour and electrical resistance</b>	<p>This characteristic defines the capacity of the floor (cladding + covering + jacks + glue) to limit the accumulation of electrostatic charges (antistatic behaviour) and to ensure their evacuation (conductivity). It also helps prevent the risk of electrocution in the event of accidental contact with live circuits. In general, a raised floor must have a transverse electrical resistance of between 5.105 and 2.1012 ohms (EN 1081).</p> <p>In most areas of raised floor use, the choice of a finishing cladding not exceeding a load voltage of 2 kV is sufficient (performance related to the cladding according to EN 1815). Earthing resistance requirements are not justified for an entire building either, but only for very specific sectors (electronic or explosive environment). In this case, it is recommended to rely on a specialized office to correctly assess the expected performance. Earthing is generally done through an equipotential bonding braid network connecting a certain number of jacks together. The choice of jacks allowing this device is then recommended.</p>
<b>Acoustic performance</b>	<p>The acoustic performance of a raised floor depends on the covering's structure and the insulation of the system. Establishing it is complex and is generally the subject of laboratory tests in use conditions, according to standard EN ISO 10848-2. In general, the denser and more flexible the panels, the better the protection against impact noise. The other parameters influencing the lateral transmission of noise are in particular the height of the plenum, the type of finish cladding, the acoustic compartmentalization (above and in the plenum), etc.</p>
<b>Dimensional tolerance</b>	<p>Maximum dimensional variations of approximately 0.5 mm are acceptable, regardless of the dimension (thickness, length, straightness, squareness, etc.), in order to guarantee the interchangeability of the coverings. These characteristics are therefore closely linked to the quality of the original product, the degree of sorting of the reclaimed coverings and the uniformity of the batch. A visual or detailed examination of the batch is often sufficient to estimate them.</p>
<b>Resistance to impact</b>	<p>The system must be able to withstand the impact of soft and hard bodies without being deformed. The EN 12825 standard recommends a detailed test method to test this ability. This characteristic can be assessed according to the whole batch and the proportion of damaged and discarded coverings.</p>
<b>Serviceability and moisture resistance</b>	<p>This depends on the type of cladding and the type of covering. For example: components made from chipboard are liable to swell under the influence of water. Large-scale cleaning is therefore prohibited. In general, it is possible to refer to the precautions for use of equivalent new products.</p>
<b>Slip resistance</b>	<p>This characteristic is defined by the type of cladding on the raised floor.</p>
<b>Thermal performance</b>	<p>If the raised floor complex belongs to the compartment enclosure, it should be ensured that it meets the required thermal insulation requirements by determining its thermal transmission coefficient U (W/m<sup>2</sup>K).</p>

### Hazardous substances and precautions

	<p>While calcium sulphate coverings emit little or no Volatile Organic Compounds (VOCs), coverings made from reclaimed chipboard particles are likely to release them, in particular formaldehyde, considered carcinogenic, mutagenic and reprotoxic. However, it is recognised that the risk of <i>formaldehyde</i> emission from particle board decreases significantly for materials produced after 1990 all the more so as their working life is long. The risk associated with the reclamation of raised floor coverings is therefore considered to be very low. In case of doubt, it is possible to carry out a laboratory test according to standard EN ISO 12460-3. It should be added that the quality of the indoor air will also be influenced by the type of cladding chosen and its means of installation.</p>
	<p><i>Pentachlorophenol (PCP)</i>. The use of this wood treatment agent (pesticide) has been regulated in Europe since the 1990s. However, there is a low risk of finding this persistent, toxic and endocrine disrupting pollutant in panels made from reclaimed wood particles. However, the absence of direct contact with the material limits the risk.</p>

- (1) Marutzky R. (2008) Opening and Thematic Introduction, Proceedings of the Technical Formaldehyde Conference, WKI, 13-14 March 2008, Hannover, Germany.
- (2) Indoor Air Pollution: An Evaluation of Three Agents – Formaldehyde, Exposure to Environmental Hazard, University of Minnesota, PubH 5103, fall semester 2003.



**Availability**

Raised floors are a very common product in the reclamation market. Few professional operators are currently able to offer a refurbishment and resale service despite the high opportunity potential. However, availability depends a lot on the quantities required. Sets of identical coverings up to 1000 m<sup>2</sup> are regularly available.

**Indicative prices (Excl. tax)**

Random sampling of the reclamation market in Western Europe (Belgium, France, Great Britain and the Netherlands) made it possible to extract some indicative prices. These vary depending on model, condition and quantities needed. It is generally necessary to calculate between 10 and 20 €/m<sup>2</sup> (raised floor coverings, without jacks or crosspieces), which seems to correspond to around 85% of the new price.

**Find specialised businesses**



salvoweb.com

[salvoweb.com](http://salvoweb.com)



opalis.eu

[opalis.eu](http://opalis.eu)



*Assessing the impact of reclaimed wood-based construction products on global warming is complex and difficult to generalize. The general principle is that construction timber can confine biogenic carbon. Reclamation is therefore a way of preserving these carbon stocks and preventing it from being released into the atmosphere (which would be the case if the wood was incinerated, for example). The overall environmental assessment of a reclaimed wooden element must, however, also take into account aspects such as the origin of the product and the distance travelled, etc. For more information, it is advisable to consult the specific paragraph devoted to this question in Sheet00\_Introductory sheet. The data collected in the table below vary significantly depending on the analysis. In all cases, the reclamation of raised floor coverings makes it possible to prevent the production of CO<sub>2</sub> from the manufacture of new coverings.*

**Embodied carbon (Cradle to gate - production A1-A3)**

	kg CO <sub>2</sub> eq./m <sup>2</sup>
INIES database (FR) - generic data (new MDF covering) - sustainable management *	42.7
INIES database (FR) - generic data (new MDF covering) - non-sustainable management *	79.3
INIES database (FR) - generic data (new mineral covering) - non-sustainable management **	95.5
MOBIUS (reclaimed MDF covering) - individual data ***	1.67
MOBIUS (reclaimed MDF covering) - individual data ****	1.05

\* Indicative value for 1 m<sup>2</sup> of raised access floor coverings in agglomerated wood (MDF) 38 mm thick and steel pan, unclad, laid on jacks for a reference service life of 25 years.

\*\* Indicative value for 1 m<sup>2</sup> of raised access floor coverings in mineral matter (calcium sulphate) 44 mm thick and steel pan, unclad, laid on jacks for a reference service life of 50 years.

\*\*\* Indicative value for 1 m<sup>2</sup> of reclaimed raised access floor coverings, unclad, placed on jacks ensuring a plenum of 300 mm, for a reference service life of 25 years.

\*\*\*\* Indicative value for 1 m<sup>2</sup> of reclaimed raised access floor coverings, with laminate cladding, placed on jacks making it possible to ensure a plenum of 300 mm, for a reference service life of 25 years.

The data relating to the life cycle analysis of these products are shown in the graph below (*Warning: comparison of products with different reference lifetimes!*).

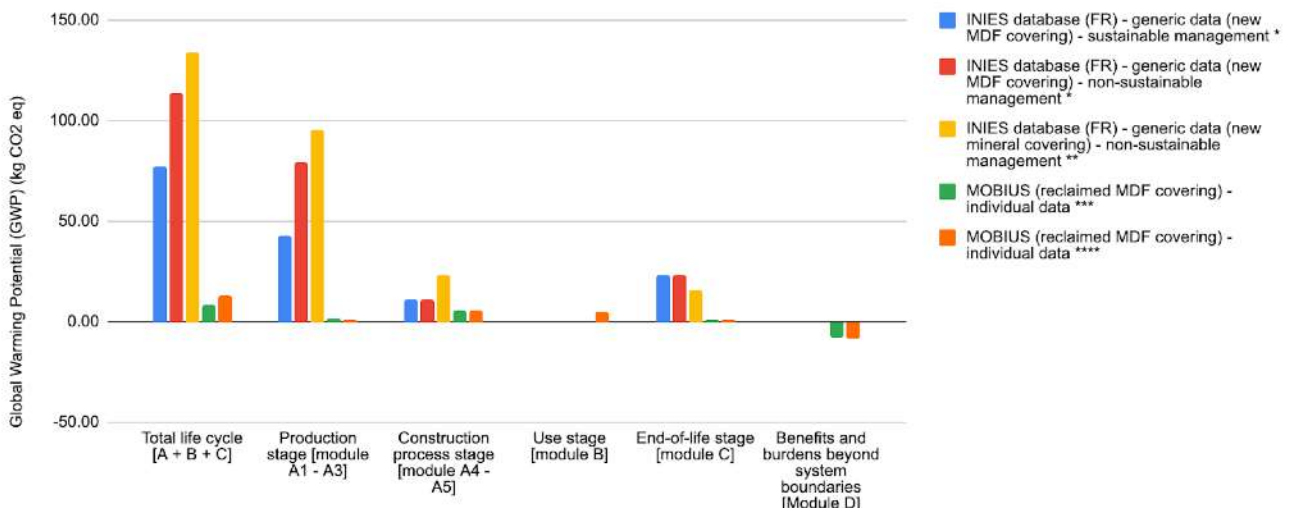



**Disclaimer**

This sheet is intended for designers, specifiers and other members of construction project teams wishing to reuse this building material or product. It is part of a collection of sheets aimed at bringing together the available information to date that is likely to facilitate the reuse of building materials and products.

This sheet has been produced by Rotor vzw/asbl within the framework of the Interreg FCRBE project - Facilitating the Circulation of Reclaimed Building Elements, supported by the entire project partnership. Sources of information include the experience of reclamation dealers and involved project partners, lessons learned from exemplary projects, available technical documentation, etc.

The sheets have been produced between 2019 and 2021. As the reclamation sector is evolving, some information, notably regarding pricing and availability, may change over the time. When the text refers to European standards, it is up to the project team to refer, if necessary, to their national implementations and local specificities.

It is important to note that the information presented here is not exhaustive or intended to replace the expertise of professionals. Specific questions are always project related and should be treated as such.

The complete collection of sheets (including the introductory sheet) is freely available from different reference websites (a.o. [opalis.eu](http://opalis.eu), [nweurope.eu/fcrbe](http://nweurope.eu/fcrbe), [futureuse.co.uk](http://futureuse.co.uk)).

Non-exhaustive directories of dealers in reclaimed building materials are available on [www.opalis.eu](http://www.opalis.eu) and [www.salvoweb.com](http://www.salvoweb.com).

---

Interreg FCRBE partnership: Bellastock (FR), the Belgian Building Research Institute / BBRI (BE), Brussels Environment (BE), the Scientific and Technical Center of Building / CSTB (FR), Confederation of Construction (BE), Rotor (BE), Salvo (UK) and University of Brighton (UK).

The information contained in this document does not necessarily reflect the position of all the FCRBE project partners nor that of the funding authorities.

Unless explicitly stated otherwise, the content of these sheets is credited in the Creative Commons Attribution NonCommercial – Share Alike format (CCBY-NC-SA).



Unless explicitly stated, the images used in this document belong to © Rotor vzw/asbl or © Opalis. Any other image has been the subject of a systematic request for authorisation from their authors or rightful owners. When this request has not been answered, we assumed that there were no objections to the use of the image. If you feel that this interpretation is unreasonable, please let us know.



## Carpet tiles

### Product Description

**Used for interior flooring, carpet tiles (also called modular carpets) find their place in residential applications, office spaces, commercial premises and in the event sector. Their dimensions and modular nature make them similar to raised floor systems (raised floors), on which they are moreover commonly fitted.**

The tiles are designed to be easily replaced in the event of localised deterioration. Their theoretical lifespan is 10 to 15 years. Carpet surfaces are however frequently replaced after only 7 to 10 years, especially for aesthetic reasons.

In principle, carpet tiles are quite suitable for reclamation. They are generally easy to dismantle and easy to package. In practice, their reclamation largely depends on their state of wear. In addition, the economic value of reclaimed tiles remains relatively low.

Carpet tiles are a product with many variations, not only in their appearance (colour) but also in their composition. There are different models suitable for different contexts.

Generally speaking, tiles consist of three distinct layers which ensure the overall performance in stain and wear resistance, touch, electro-conductivity, acoustics, fire resistance, etc.:

→ **wear layer**, sometimes called "pile": made up of synthetic fibres (polyamide, polypropylene, polyester, etc.) or, more rarely, natural fibres (wool, goat hair, etc.).

→ **backing fabric**: textile, woven or not, on which the fibres are attached (= first backing), in synthetic or natural materials.

→ **padding** (= second backing): consisting of several layers of materials such as bitumen, PVC, polyolefin, polyurethane, synthetic felt, woven fabric, synthetic foam, latex, etc. The composition of the padding largely determines the acoustic properties of the tiles as well as their method of installation and the choice of glue to be used.

Other parameters are used to characterise the tiles:

→ **Texture**, depending on the manufacturing process and the density of the yarns: most of the time looped or *tufted*, there are also textures such as cut or ribbed pile, woven, frieze, saxony, needled or even long shaggy hairs.

→ **Variable appearance**: plain, multicoloured, layered, patterned, etc.

→ **Formats**: most carpet tiles have a standard size of 50 × 50 cm and a variable thickness of 5 to 10 mm. Other formats exist but are rather rare.

→ **Weight**: from 3.5 to 5 kg/m<sup>2</sup>.

→ **Type of installation**: carpet tiles were formerly held in place by means of glues or non-permanent binders such as "tack" glue, fixers or even adhesive tapes. Innovations on the back of the tiles have progressively made it possible to market so-called "non-adhesive" tiles, which do not need to be fixed to the substrate and which can be placed freely. These are very easy to dismantle.

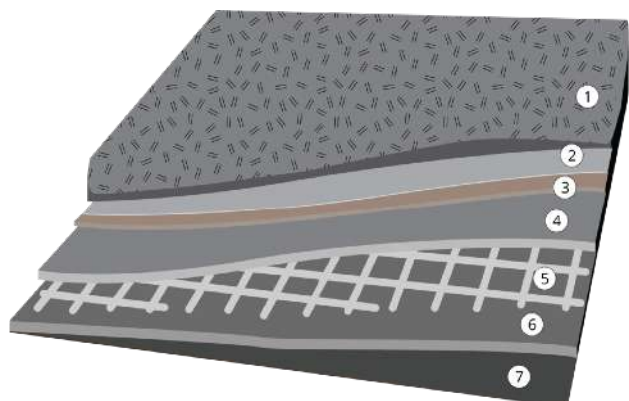
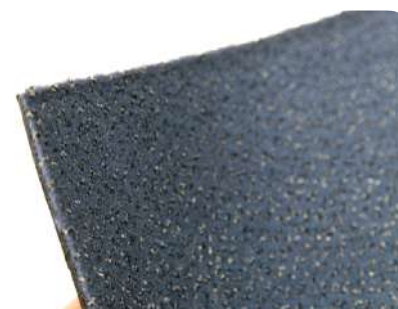

- (1) Wear layer
- (2) Backing fabric = first backing
- (3) + (4) + (5) + (6) + (7) Padding = second backing

Anatomy of a carpet tile



### Product reclamation

**Salvageable carpet tiles are mainly found in office spaces or commercial buildings. They are usually found laid on raised floors or directly on a smooth concrete screed. Recent tiles (<15 years) are often easier to remove. It is possible to reclaim them on site or send them to the few companies active in the recovery of this product. Their reclamation potential will depend essentially on the model, the quantities in place and the general condition of the batch.**

→ *Evaluation of potential*: an "expert eye" generally makes it possible to estimate the potential for reclamation during an on-site visit or based on photos and technical information relating to the model, manufacturer, quantities, dimensions, etc. The points of attention are among others:

- general condition: wear (often more pronounced where there were office chairs with casters), presence of stains and humidity, cut elements, deformation of edges and corners, etc.
- the installation method: glue, fixatives, loose installation, etc.
- the available documentation (technical sheets, declaration of performance, etc.) and the assessment of the conditions of use.
- commercial interest, depending on model, quantity and the resale potential.
- logistical arrangements, including deadlines, handling, organisation of transport, etc.

→ *On-site performance assessment*: as far as possible, the batches of tiles in place should be studied in detail before the removal and sorting steps, in order to better characterise certain features which will be more complicated to establish once the batch is dismantled (see § Characteristics and fitness for use). In particular, the identification of any discoloured areas or pronounced areas of wear makes it possible to surmise the sensitivity of the entire batch to these aspects.

→ *Removal*: careful dismantling should aim to ensure the integrity of the coverings and workers' safety. As a first step, it is advisable to ensure the absence of dangerous substances (although they are extremely rare, it is not impossible to meet asbestos glues) and to proceed with the de-energisation of the

electrical networks. connected to the floor. In order to facilitate their reclamation, it may be best to clean the tiles in situ. If wet cleaning is planned, it is necessary to allow sufficient drying time before removal.

The carpet tiles are generally removed by means of a flat tool (such as a spatula), slipped between the tile and the substrate to carry out the delicate removal. Depending on the installation method, this operation is more or less easy. *The use of shovels, screwdrivers or carpet strippers is to be avoided* because it damages the edges and corners of the tiles. Similarly, pulling too fast tends to damage the tiles. The recoverable tiles must be completely flat.

In some cases, tiles that were located under heavy static loads or subjected to frequent passage (typically under office chairs) tend to adhere more strongly to the substrate, to the point of sometimes tearing slightly during removal.

In order to guarantee the uniformity of the batches, the tiles removed are sorted by type. Items that are deformed, cut, torn or have a questionable appearance should be avoided. It may be advisable to separate the batches according to the original application (for example according to the premises of origin or the estimated frequency of passage). Self-checking procedures can be implemented during removal.

The means of handling the dismantled tiles must be considered taking into account the load capacity (static and dynamic) of the floors and evacuation exits. The stack of tiles can quickly become large.

The following items are recommended to avoid deformation of the tiles during the handling steps:

- Place a rigid flat panel on the pallet's base.
- Store the tiles flat and in bundles on pallets: generally 4 stacks of 1 m to 1.2 m per pallet.
- Prevent the tiles from overflowing the pallet.
- Prohibit the use of straps and strapping means generating forces likely to deform the tiles.
- Make use of a stretch film to hold the tiles on the pallet, avoiding deforming the corners.

When the presence of glue has not prevented removal, it is still necessary to ensure that any remains of glue do not alter the visible face when the tiles are stacked. Storage on the underside against the underside is therefore to be preferred.

It is strongly recommended to label each pallet at the time of removal to ensure product traceability.



Back of a carpet tile laid without glue.



Movement of tiles using trolleys. The staggered arrangement facilitates handling.





→ **Treatments**: if sorting was not carried out during removal, it can take place in the workshop. Professional resellers of reclaimed carpet tiles generally classify products into three categories, depending on the condition of the batches (see § Reclamation indicators).

→ **Storage**: it is recommended to store carpet tiles at room temperature, away from humidity and dust, avoiding too much sunlight.

→ **Transport and delivery**: the necessary precautions must be taken during transport and delivery in order to minimise the risk of scraps or tangling.

It is advisable to involve specialised professionals to ensure the smooth running of these operations.



Stock from a supplier of reclaimed and surplus carpet tiles ([www.sparo.nl](http://www.sparo.nl))

#### Marking and original performances

You can generally find printed on the underside of the tiles indications allowing their origin to be traced and the technical sheet describing the initial performance of the product to be found. However, some of this performance may weaken over time. This is especially the case when they depend on chemicals used as flame retardants, anti-stain, anti-static, anti-bacterial or anti-allergic treatments. If the intended use requires precise knowledge of the actual performance of the tiles, it may be necessary to supplement the information available with specific test measurements. These steps must be considered according to the needs relating to the intended use. They must then be integrated into the economic evaluation of the operation and strongly depend on the size of the batch considered.



Stock from a supplier of reclaimed and surplus carpet tiles ([www.sparo.nl](http://www.sparo.nl))



**Applications and laying**

**Reclaimed carpet tiles can be used for applications subject to moderate stress (residential) or more intense (commercial use, office buildings, halls and corridors). They can be placed on different surfaces (wood, concrete, etc.) as long as the ground is level, dry and free of all debris. The choice of tiles must necessarily take into account the expected stresses (see § "Characteristics and fitness for use). In all cases, reference should be made to the European and national standards relating to the product (e.g. EN 14041 and EN 1307+A3) and to the rules of practice in force (or implementation standards).**

The re-installation of correctly sorted and cleaned used carpet tiles is no different from that of new tiles. It raises the same points of attention, in particular: choice of materials and associated performances, installation method (glued, fixed or free), layout and direction of installation, properties and condition of the substrate, grip of the tiles, height on a level with the doors, thermal and acoustic insulation, fire resistance, electric conductivity, expansion joints, underfloor heating, peripheral profiles and precautions, maintenance procedures, costs, etc.

Before laying, it is important to ensure that the tiles are properly acclimatised to the ambient conditions.

In order to reduce the entry of dirt and prolong the life of the carpet tiles, it is useful to provide a protective device at the entrances (doormat, etc.) as well as a maintenance program compatible with the use of spaces. Choosing colours that are less sensitive to stains is also an option.

Acoustic comfort can be improved by a special underlay provided for this purpose. This system should be considered in the case of the reclamation of carpet tiles not provided with integrated acoustic performance.

To facilitate laying, the designer/specifier will take care to use batches with a certain degree of uniformity in terms of the following characteristics:

→ *Composition of the batch*: the batch must consist of tiles of the same type and of the same format (including the thickness). Ideally, a batch must also consist of tiles having the same origin in order to guarantee a certain uniformity as to the stresses to which they have been subjected.

→ *Appearance*: colour variations are possible. These variations are mainly due to the original exposure and use. Depending on the desired effect, it is advisable to mix the tiles when laying.

→ *Condition*: reclaimed tiles may show signs of deterioration such as signs of surface wear, stains or knocks.

→ *Quantity*: some suppliers may include surplus when the product is delivered if they are not able to guarantee the absolute uniformity of the characteristics mentioned above. This surplus can also be applied in the case of an on-site salvage scenario. It is also advisable to provide a surplus of tiles on the one hand for the installation of the tiles in the space (for example: 10% more to ensure the cuts on the periphery of the room for a chequerboard installation and 20% more for a diamond installation) and on the other hand to ensure the subsequent replacement and repairs of certain parts.

Most professional suppliers are able to ensure that delivered batches meet these requirements.

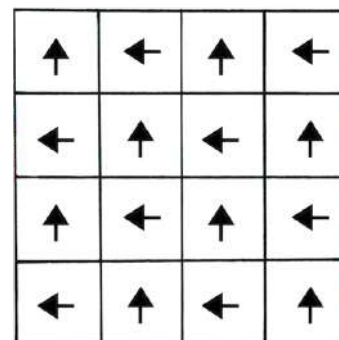

A.

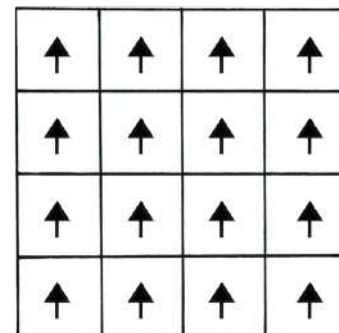

B.

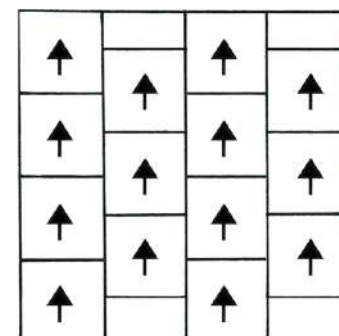

C.

Examples of types of installation: A. chequerboard, B. parallel, C. staggered joints. The arrows indicate the direction of installation, generally perpendicular to the left of the fibres, and indicated on the back of the tiles.

**Design tip!**

To increase the chances of meeting the offer available on the reclamation market, the designer/specifier can choose to accept several different batches and distribute them in an organised manner in the building. For example, plan a uniform batch of carpet tiles per space or per floor. Or even, play on a principle of patchwork in spaces that lend themselves well to it.

**Think reversible !**

At equivalent performance, the choice of loose-carpet tiles or not glued is preferable. Easier to remove, they promote reclamation, both of the covering and of the substrate. In addition, innovative fixing systems allow tiles that do not meet the requirements of loose installation to be held together, without adhering to the substrate (e.g.: repositionable adhesive such as Tac Tiles , etc.)



## Characteristics and fitness for use

**The harmonised European standard EN 14041 establishes the relevant characteristics (depending on the context) in order to determine the fitness for use of modular resilient, textile, laminate and multilayer flooring.**

Standard EN 1307+A3 specifies the requirements relating to the use classification of textile floors. A first distinction concerns the residential (domestic) or commercial (public) nature. Within each of these categories, a second distinction concerns the intensity of use:

- Moderate: room or hotel room
- Ordinary: living room, hallway, waiting room, shop, collective offices
- High: kitchen, exterior rooms in a house, cafeterias, restaurants
- Very high: museums, company restaurants, department stores

Each category is associated with specific performance requirements, in particular in terms of resistance to wear, preservation of appearance or even comfort class. There are other classifications of uses, for example the UPEC classification.

Although detailed for new products, the characteristics developed in these standards may prove useful in considering the specific case of reclaimed carpet tiles. The expected performance can be determined in several (possibly complementary) ways:

- Analysis of the batch in place (for example for discoloured areas, general condition, absence of damp spots)
- Feedback from previous users (for example for antistatic behaviour or walking comfort).
- Original technical documentation (for stable performance over time).
- Standardized test measurements (for example: Vettermann drum, Lisson test).

Relevant characteristics	Comments
<b>Wear resistance</b> <b>Colour fastness,</b> <b>Light stability,</b> <b>Suitability for a wheelchair,</b> <b>Fraying behaviour,</b> <b>Resistance to soiling,</b> <b>Dimensional stability</b>	<p>These characteristics are closely related to:</p> <ul style="list-style-type: none"> <li>• the nature and quality of the materials constituting the tiles. For example: 100% polyamide tufted carpets tend to resist wear and fraying better.</li> <li>• the technicality of the manufacturing process. For example: the backs reinforced with a layer of polyester, polypropylene and/or a glass fabric, have better dimensional stability.</li> <li>• the nature and intensity of the stresses during use.</li> <li>• the relevant evaluation of the batch of tiles used (for example: the identification of discoloured tiles in places of intense light indicate a sensitivity of the entire batch to light. In the same way, if the tiles located in offices show signs of wear due to the chairs with wheels, it is indeed the entire batch that must be classified as sensitive to this stress).</li> <li>• the quality of the tile sorting</li> <li>• the uniformity of the batch of tiles recovered</li> </ul> <p>A visual or detailed examination of the batch is often sufficient to estimate them. Examining the batch in place offers useful information.</p>
<b>Walking comfort</b>	This characteristic is closely linked to the nature of the materials and the degree of wear of the tiles. For example, polyamide pile is considered more resistant and has significant walking comfort (spring).
<b>Slippage resistance</b>	The slip resistance performance of an installed floor covering can be affected by the installation, the surface treatment applied during installation, dust accumulation, cleaning and maintenance. If the tiles have been properly maintained during their first life in use, this characteristic can be considered acceptable if they are clean, dry, free of oil, grease and other slippery substances.
<b>Light reflection</b>	This characteristic, evaluated by determining the LRV coefficient (light reflectance value) determines the quantity of light reflected and absorbed by the covering. In general, dark colours absorb light while light colours reflect it, which can result in a need for differentiated artificial light (and therefore energy consumption). The structure of the tiles and their gloss also have an influence.





Characteristics	Comments
<b>Moisture resistance</b>	Depending on their nature, carpet tiles are more or less sensitive to humidity (for example, polyamide pile tiles are more sensitive than polypropylene pile ones). Tiles from damp rooms should be avoided.
<b>Acoustic properties</b>	Determining the acoustic performance of carpet tiles is complex and depends on several factors. It is generally the subject of laboratory tests in use conditions (measurement of impact sound insulation and sound absorption). In general, textile floor coverings mainly absorb medium and high frequencies.
<b>Thermal properties</b>	In general, the influence of a textile covering on the overall thermal resistance of a floor complex is low. However, the thermal conductivity inherent in carpet tiles can influence thermal comfort (“barefoot” feeling) and compatibility with the underfloor heating system. If necessary, this performance can be evaluated by means of specific test measurements or by assessing the initial operating conditions.
<b>Electrical properties</b>	The anti-static behaviour and the electric conductivity define the capacity of carpet tiles to limit the formation of electric charges and to discharge them. These properties depend essentially on the composition of the tiles, the degree of use and the relative humidity of the room. Special products can improve this performance during the production of new tiles or by means of repeated impregnations during their working life. However, the components used as anti-static have a limited lifespan. Only specific tests make it possible to know this characteristic. This is mainly required in sensitive environments such as IT rooms, hospitals and laboratories.
<b>Reaction to fire</b>	<p>Specific requirements for the reaction to fire of claddings are determined by national regulations. These requirements depend, among other things, on the use of the premises (for example: private or community housing, emergency exits, terraces on flat roofs, etc. but also on the ability of users to evacuate the premises in the event of fire (senior citizens' residence, hospital, etc.).</p> <p>The classification of construction products according to reaction to fire is defined by European standard EN 13501-1 (Euroclass) and is assessed in particular on the basis of a test carried out under the final application conditions (e.g.: carpet tile + glue + substrate). By way of example, depending on their composition and their possible treatment with flame retardant products, new carpet tiles are most of the time classified B<sub>fl</sub>, s1, C<sub>fl</sub>, s1 (little flammable, a requirement generally required for service sector buildings) or E<sub>fl</sub> (flammable, sufficient requirement for the residential sector).</p> <p>In the case of reclaimed tiles, it is difficult to determine the fire behaviour without prior laboratory testing. Indeed, depending on the conditions of use and the intrinsic characteristics of the components, it is very likely that the original fire performance has been modified. Many flame retardant treatments are indeed influenced by ageing and no longer guarantee the original performance.</p> <p>To our knowledge, there is no simple solution to improve the fire behaviour of reclaimed carpet tiles. In situ treatment solutions are generally liable to increase soiling, and their duration of action depends on the level of stress.</p>
<b>Hazardous substance content and durability</b>	<p>Many hazardous substances can be found in old carpet tiles (See § Hazardous substances and precautions). It is difficult to quantify their content without test measurements.</p> <p>The composition of more recent tiles has improved markedly in recent years and several labels have been put in place by the industry to provide environmental guarantees to their products. For example : GUT, Blue Angel, Nordic Swan. The guarantees provided are variable (for example Blue Angel and Nordic Swan restrict the use of 51 of the 59 toxic substances identified in the manufacture of carpet tiles, while the GUT label, the most used, bans only 13).</p>



**Availability**

Given the high level of performance required for their main applications (particularly reaction to fire in the services or commercial sector), carpet tiles are relatively seldom reused in these sectors.

While carpet tile producers have invested a fair amount of effort in organizing the collection of used tiles, they are generally not put back into circulation for reuse. Rather, they end up in traditional waste treatment channels (mainly incineration and landfill and, to a lesser extent, partial recycling).

It is possible that the relative ease for users to resort to these well-organized recovery channels has the consequence of diverting large quantities of potentially salvageable tiles from the reclamation circuits.

In any event, professional dealers who supply reclaimed carpet tiles are relatively rare these days. They are mostly found in Great Britain and the Netherlands. In contin-

ental Europe, the focus is mainly on surplus carpet tiles (overstocks, rejected lots, etc.) and only to a limited extent on used tiles. We should also mention the very frequent presence of large batches of (unsorted) tiles on certain digital platforms in Europe.

In general, availability depends on the model and the quantities sought. As an example:

Frequent	1 → 100m <sup>2</sup>
Occasional	200 → 500m <sup>2</sup>
Rare	> 500m <sup>2</sup>

**Indicative prices (Excl. tax)**

Random sampling of the reclamation market in Western Europe (Belgium, France, Great Britain and the Netherlands) made it possible to extract some indicative prices. These vary depending on model, condition and quantities available. The selling price is between 3 and 15 € per square meter (about 30% of the new price).

Most of the time, tiles are sold uncleaned, in whole batches or per square meter. The main resellers generally distinguish between 3 distinct qualities:

- A quality or new appearance: no stains, tears or discolourations, all corners and edges in good condition.
- B quality or good appearance: possible slight signs of previous use.
- C quality or worn look

**Find specialised businesses**



[salvoweb.com](http://salvoweb.com)

[opalis.eu](http://opalis.eu)

In the United Kingdom:  
<https://carpetrecyclinguk.com/find-used-carpet-tiles/>

**Embodied carbon (Cradle to gate - production A1-A3)**

	kg CO <sub>2</sub> eq./m <sup>2</sup>
INIES database (FR) – Generic data– soft carpet flooring *	26.2
INIES database (FR) - UFTM collective data **	9.87
INIES database (FR– UFTM collective data ***	17.4
INIES database (FR) - Individual data - Tarkett (100% recycled) ****	5.35
ICE Database (UK)- Carpet tile *****	13.7

\* Indicative value for 1 m<sup>2</sup> of soft carpet floor covering (tufted, needle punched, flocked) for a reference lifespan of 10 years.

\*\* (Union Française de Carpets et Moquettes): indicative value for 1 m<sup>2</sup> of floor covering in tufted carpets in removable floating tiles with 100% polyamide pile and a total pile mass of **less** than 750 g/m<sup>2</sup>, for a reference lifespan of 10 years.

\*\*\* (Union Française de Carpets et Moquettes): indicative value for 1 m<sup>2</sup> of floor covering in tufted carpets in removable floating tiles with 100% polyamide pile and a total pile mass **greater** than 750 g/m<sup>2</sup>, for a reference lifespan of 10 years.

\*\*\*\* Indicative value for 1 m<sup>2</sup> of soft carpet flooring (100% recycled yarn) for a benchmark lifespan of 10 years.

\*\*\*\*\* Indicative value for 1 m<sup>2</sup> of polyamide carpet floor covering and total pile mass **equal** to 700 g/m<sup>2</sup>.



Reusing 100 m<sup>2</sup> of tiles prevents the production of ~ 535 to ~ 2620 kg of CO<sub>2</sub> equivalent related to the manufacture of new tiles (production phase only). According to sources, this corresponds to the emissions of a trip of ~ 3.200 to ~ 15700 km in a small diesel car.



## Dangerous substances and precautions

Due to their synthetic composition, carpet tiles almost always contain a number of substances that are hazardous to human health and the environment. Contamination in humans can occur through skin contact, inhalation or ingestion and the consequences are multiple: skin and respiratory allergens, carcinogens, mutagens, risks for reproduction, endocrine disruptors, etc. These toxic substances are harmful to varying degrees at almost all stages of the product's life (manufacture, installation, use phase, upkeep and maintenance, end of life, recycling, landfill, incineration). Although considerable efforts have been made by manufacturers in recent years to bring healthier products to market (including relying on various labels), there are still many barriers to bringing 100% healthy, ecological and totally recyclable products to market. As an indication, here are some dangerous substances that can be found in variable and quantifiably difficult quantities in reclaimed carpet tiles:

→ Volatile organic compounds (VOCs): formaldehydes, phthalates, etc. The harmfulness of these substances is particularly high at the start of installation of the new product or following the use of unsuitable application adhesives. VOC emissions decrease over time. Reclaimed tiles are therefore much less prone to it.

→ Additives used for the specific treatment of carpet tiles: antibacterial agents, flame retardants, anti-soiling, anti-static, etc. These compounds tend to migrate into the ambient air (during cleaning, for example) and into the waste water. Depending on their concentration and persistence, they can affect the health of occupants and the environment in the longer or shorter term.

→ Others: heavy metals (Lead, cadmium), PAHs (Polycyclic Aromatic Hydrocarbons), dyes and colourants, PVC, etc.

For more information :

- *Toxics in Carpets in the European Union*, Anthesis Consulting Group, 2018 (<https://circulareconomy.europa.eu/platform/sites/default/files/knowledge-toxics-in-carpets-eu-review-anthesis-final-study.pdf>)
- *Eliminating Toxics in Carpet: Lessons for the Future of Recycling*, Jim Vallette, Rebecca Stamm, Tom Lent, Healthy Building Network, 2017 ( <https://healthy-building.net/reports/1-eliminating-toxics-in-carpet-lessons-for-the-future-of-recycling> )

*Most manufacturers of new carpets have adapted their manufacturing processes to incorporate a certain proportion of materials from the recycling of waste such as fishing nets or PET bottles. Some companies have also sought to set up collection channels for used tiles. In practice, however, a large majority of tiles end up in landfill or being incinerated. Their highly composite nature, the possible presence of toxic compounds and the difficulty of separating the various constituent elements strongly hamper the possibilities of recycling.*

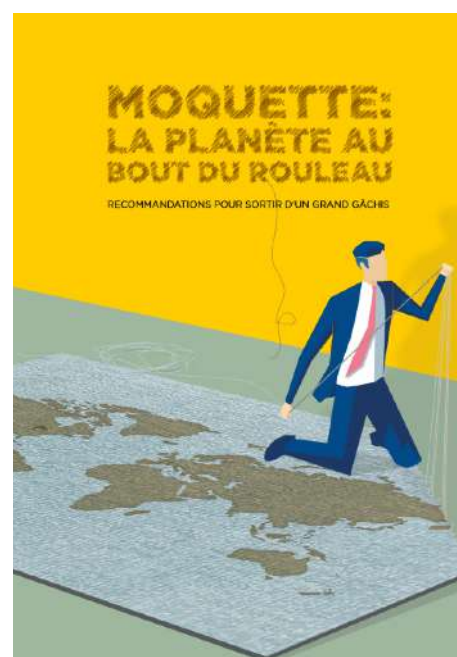

[To read] *Carpets: The planet at the end of the roll, recommendations for getting out of a big mess*, 2017, Zero Waste and Changing Markets (in French) <https://www.zerowaste.france.org/wp-content/uploads/2018/03/rapport-moquette-zwfrance.pdf>





## Natural stone flooring slab

### Disclaimer

This sheet is intended for designers, specifiers and other members of construction project teams wishing to reuse this building material or product. It is part of a collection of sheets aimed at bringing together the available information to date that is likely to facilitate the reuse of building materials and products.

This sheet has been produced by Rotor vzw/asbl within the framework of the Interreg FCRBE project - Facilitating the Circulation of Reclaimed Building Elements, supported by the entire project partnership. Sources of information include the experience of reclamation dealers and involved project partners, lessons learned from exemplary projects, available technical documentation, etc.

The sheets have been produced between 2019 and 2021. As the reclamation sector is evolving, some information, notably regarding pricing and availability, may change over the time. When the text refers to European standards, it is up to the project team to refer, if necessary, to their national implementations and local specificities.

It is important to note that the information presented here is not exhaustive or intended to replace the expertise of professionals. Specific questions are always project related and should be treated as such.

The complete collection of sheets (including the introductory sheet) is freely available from different reference websites (a.o. [opalis.eu](http://opalis.eu), [nweurope.eu/fcrbe](http://nweurope.eu/fcrbe), [futureuse.co.uk](http://futureuse.co.uk)).

Non-exhaustive directories of dealers in reclaimed building materials are available on [www.opalis.eu](http://www.opalis.eu) and [www.salvoweb.com](http://www.salvoweb.com).

---

Interreg FCRBE partnership: Bellastock (FR), the Belgian Building Research Institute / BBRI (BE), Brussels Environment (BE), the Scientific and Technical Center of Building / CSTB (FR), Confederation of Construction (BE), Rotor (BE), Salvo (UK) and University of Brighton (UK).

The information contained in this document does not necessarily reflect the position of all the FCRBE project partners nor that of the funding authorities.

Unless explicitly stated otherwise, the content of these sheets is credited in the Creative Commons Attribution NonCommercial – Share Alike format (CCBY-NC-SA).



Unless explicitly stated, the images used in this document belong to © Rotor vzw/asbl or © Opalis. Any other image has been the subject of a systematic request for authorisation from their authors or rightful owners. When this request has not been answered, we assumed that there were no objections to the use of the image. If you feel that this interpretation is unreasonable, please let us know.



**Material description**

**By definition, flooring slabs of natural stone are modular flooring elements used both indoors and outdoors. Thinner than cobbles and larger than tiles, flooring slabs come in a wide variety of types. For a long time, they were cut manually with a spike, chisel and mallet, using traditional techniques. These old slabs can be recognised by their greater thicknesses and their more irregular contours. They were gradually excluded by increasingly regular standardised elements resulting from mechanical sawing.**

Like other natural stone materials, the reuse of flooring slabs is a relatively common practice. There are many companies specializing in the recovery and resale of this material. The supply of reclaimed flooring slabs is stable although batch sizes can vary greatly from one batch to another (from a few dozen to several hundred square meters).

This sheet mainly focuses on the use of natural stone slabs for interior and exterior flooring.

The reclamation market has a wide variety of flooring slabs models. These often reflect historical and regional specificities. Several criteria make it possible to distinguish them:

→ **Formats:**

- Square or rectangular slabs with dimensions up to 1 metre per side.
- Church slabs in limestone. These are old slabs of variable sizes, square or rectangular. Their upper face is smooth, their underside is very irregular and their thickness is significant (~ 15 cm).
- Burgundy stone slabs. These are large, thick slabs from old buildings that are very common on the market in France. The typical installation consists in pairing rectangles of various formats.
- "Broken" slabs. These are fragments of broken slabs which are generally assembled in opus incertum.

→ **Geological nature.** Many types of rocks were used in the manufacture of slabs. Among the most common on the reclamation market, we find granite, marble, sandstone, slate, blue stone and white limestone, in all their local variations. There are also slabs made from porphyry, basalt, gneiss, travertine and other rocks.



Ancient Burgundy slabs © [authentic.fr](http://authentic.fr)



White marble (Carrara)

**Terminology!**  
  
Depending on the geographical context, or the geometrical characteristics of the elements, or even the nature of the stone, the slabs can also be called "Flags" or "Flagstones".



Black marble



Sandstone © [London Reclaimed Brick Merchants Ltd](http://London Reclaimed Brick Merchants Ltd)



Granite



Belgian blue stone



Slate © [Stox Reclamation](http://Stox Reclamation)



Old blue stone church slabs (BE)  
© [Sophie Boone](http://Sophie Boone)



Mix of square York sandstone slabs and "broken" slabs laid in Opus Incertum, Holland Park, London (UK) © [Thornton Kay/Salvo](http://Thornton Kay/Salvo)





## Natural stone flooring slab

→ **Dimensions.** Usually, reclaimed slabs have widths and lengths between 30 and 100 cm and thicknesses between 2 and 15 cm. However, it is not uncommon to find elements with more specific dimensions.

→ **Appearance.** The diversity of rocks is reflected in a wide range of colours, including within the same family: grey, beige, ochre, brown, pink, bronze, etc. A specific vocabulary is used to designate the stone inlays: veins, grains, strata, flames, stains, etc.

In addition to the original appearance of the rock, the slabs can bear the marks of their cutting method (cleavage, sawing) and of their original finish (flaming, sanding, shot blasting, bush hammering, polishing, etc.). Usually the underside of the slabs has a much coarser texture. Over time, their appearance also varies according to the stresses of use: softening, polishing of the visible face, darkening of the hue, rounding edges, traces of paint, mortar or bitumen on the underside, growth of organisms (algae, mosses, lichens, etc.), etc.

→ **Installation type.** Different types of installation are to be found:

- laying slabs on a flexible base (sand, earth, etc.);
- laying slabs on platforms;
- laying of embedded slabs: plaster, lime mortar, bastard mortar or cement mortar;
- laying of bonded slabs: adhesive mortar.

→ **Original grouting.** The mortar grout fills the space between the stones with a binder. The choice of grouts and their thickness is determined according to the type of installation, the location of the slabs, the nature of the stone and the regularity of the slab's edges. The slabs can also be laid without mortar which facilitates their recovery. We speak of a dry joint or a live joint if the slabs are laid edge to edge. There are also flexible joints (sand, gravel, topsoil, etc.).



Slabs on sand © Perrine Henault, [Atelier NOUS](#)



Slabs on platform  
© [agencementpierres.com](#)



Sealed slabs



Bonded slabs © [stonenaturelle.fr](#)

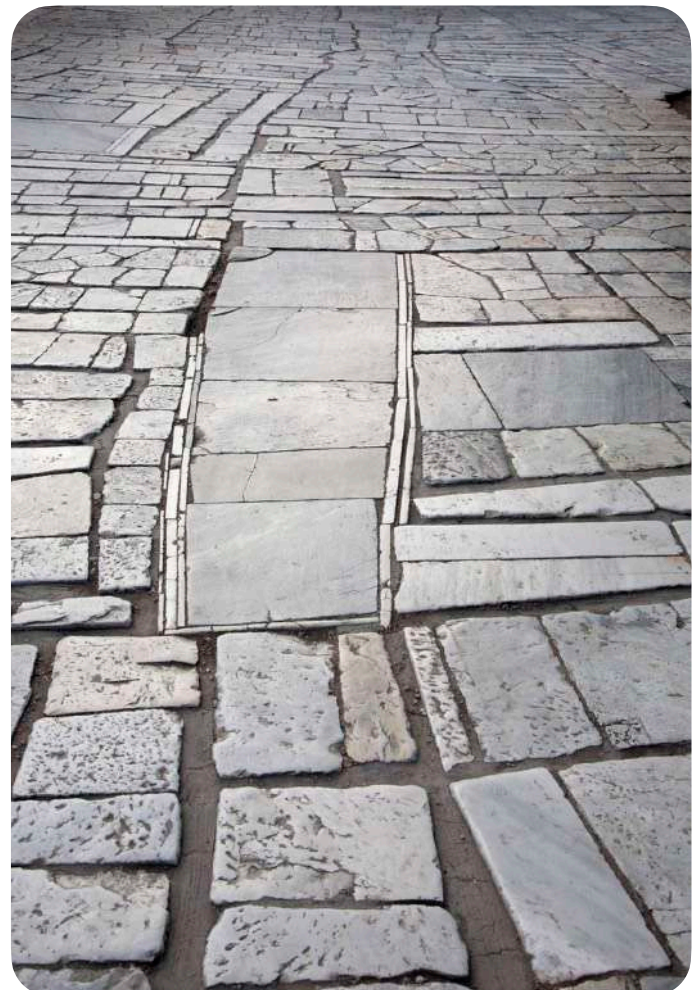

Reused paving slabs on the way to the Acropolis in Athens (GR), 1930. Píkionis  
© Mayte Piera





## Natural stone flooring slab

### Material reclamation

**Natural stone slabs are a good candidate for reuse, either on-site or through the professional channels of material resellers. They can also ensure the supply of batches of slabs ready for installation.**

**They are able to ensure the smooth running of the following operations:**

→ *Disassembly test* (or expert opinion). A disassembly test makes it possible to ensure the feasibility and profitability of a removal. It may possibly be supplemented by cleaning tests of the remains of mortar and grout). An “expert eye” generally makes it possible to estimate the interest of a batch based on plans, photos, historical documents or by an on-site visit. The focal points for slabs will be among others:

- the general condition of the batch and the laying method: condition of the stone, formats, thicknesses and dimensions, nature of the laying bed, characteristics of the joints, etc.
- commercial interest, depending on model, quantity, salvage and resale potential, specific regional particularities, etc.
- logistics arrangements: especially in terms of deadline, working time, handling, transport, etc.

→ *Removal*. Careful dismantling should aim to ensure the integrity of the slabs and a certain uniformity of the batches. It is particularly easy if the slabs are laid on a platform or, to a lesser extent, if the adhesion between the laying bed and the slab is weak. This is particularly the case for laying in a lime mortar bed or on stabilised sand. However, this operation will be more complicated if the slabs are bonded or embedded with cement mortar (which will also complicate cleaning). To minimise the risk of deterioration during dismantling, it is advisable to weaken the tensions within the slabs by first freeing 2 sides (perpendicular) of the slabs. This usually involves breaking non-free edge lines. The type of joint also influences the ease of recovery and cleaning of the slabs. For example, epoxy grout often causes damage during disassembly. To optimise the recovery rate, it may be useful to first open the joints using appropriate tools (e.g. diamond rail saw, pressurised water, etc.) and use handling equipment suitable for the cladding to prevent splintering.

→ *Sorting and cleaning*. Slabs of the same covering can show different degrees of wear depending on their location, which is why it is useful to sort them during dismantling, for example according to their quality, their colour, their dimensions or even their degree of soiling. Slabs that are split or have significant defects are downgraded. Cleaning with water, by scraping or by mechanical abrasion (e.g. stone cutter), is generally sufficient to remove the residues of the bedding layer, grouting products and other elements liable to adhere to the stone.

→ *Storage and packaging*. The slabs are generally stored outside, arranged on their edges in wooden crates or packaged horizontally and strapped on pallets. Depending on the fragility of the slabs to be kept, they are sheltered to avoid contact with the ground and thus providing possible protection against frost. Ideally, they are separated by wedging elements in order to limit the risk of damage. The wedge/separation wood must not be treated, be very dry and not contain tannins which could stain the stones. Metal straps should be avoided as there is a risk of staining the stone (rust). The packaging must take into account the large mass of the elements. Appropriate means of transport and lifting are also required.



“Breaking” a first line



Sawing joints



Removing the slabs



Unstacking slabs



Sorting slabs



Transport and loading of slabs



## Natural stone flooring slab



Storage on the edge in wooden crates



Pallet storage



Storage on a strapped pallet, face to face  
© De Opkamer

→ **Operations.** While some slabs can be reused as is after a rough cleaning, others may require additional operations:

- **Sawing:** to obtain flat faces or to make the dimensions uniform. The thickest slabs (> 10 cm), such as Burgundy slabs, can be sawn along their thickness. The upper part, which has the original patina, is sold for a high price while the remainder is usually sold for much less.
- **Thorough cleaning:** the visible face of some more porous stones may be stained or have changed colour during use due to atmospheric pollution, the passage of users or the growth of moss. Their restoration to original condition is not always possible. It depends on the depth of encrustation, which varies according to the type of pollution and the type of stone. It is advisable to contact a professional to know the compatible products and the appropriate treatment methods. Several techniques are possible: water polishing (different pressures and temperatures), use of chemicals (oxalic acid, polishing chemicals, polishers), mechanical cleaning (sanding, polishing, sandblasting, projection of fine particles, micro-sanding, etc.) or even, in very specific cases, use of laser, latex or poultices. The choice of a suitable cleaning technique will depend essentially on the following aspects: nature and hardness of the stone, fineness of its grain and other surface aspects, presence of alterations, type and degree of soiling, desired result.
- **Finishing:** it is very rare that reclaimed slabs undergo a surface treatment in the workshop. In general, the desire is rather to preserve their patina. However, to meet the desired requirements (standardise the appearance of the stone, give it a rough appearance, etc.) several finishing techniques are possible depending on the nature of the stone and the expected performance:

bush hammering, sanding, flaming, shot blasting, pitting, etc. A specific vocabulary determines the type of finish depending on the type of rock concerned.

These various operations can be carried out by specialised resellers within their facilities. They can also be considered on site, provided that the site logistics allow it.

Ready-to-install slabs are clearly identified and labelled in uniform batches. They are sold by the square meter or by the ton. Most suppliers are able to provide information on their main characteristics: type of rock, nominal dimensions and tolerances, finish, intended applications and, in certain cases, their origin.



Removal of mortar residues from the edge using a lapidary machine



Cutting stone elements



Removal of mortar residues with a pneumatic chisel  
© De Opkamer



Bush hammering of slabs



Thickness sawing of the slabs, thicker and irregular bottom part



Thickness sawing of the slabs, smooth and even top part





## Natural stone flooring slab

### Applications and laying

Reclaimed slabs are mainly used as modular elements for covering indoor or outdoor floors. They are generally reserved for applications subject to moderate stresses: indoor floors, terraces, pedestrian zones, squares, alleys, cycle paths or squares subject to light vehicular traffic (least loaded traffic category). Their resistance to mechanical loads depends overall on their format: the more compact their dimensions (close to a paving stone), the better they resist bending. In this sheet, we consider the reuse of flooring stones for identical uses. However, it is possible to reuse these elements elsewhere (see for example the sheet devoted to natural stone wall cladding slabs).

The choice of a type of slab depends of course on the intended uses (interior, exterior, traffic intensity, etc.). Conversely, the reclamation possibilities of a given batch depend on its intrinsic characteristics. If necessary, specific operations (cutting, finishes, etc.) make it possible to adapt the characteristics of the slabs to meet new use requirements (for example in terms of roughness, ease of maintenance, surface rendering, etc.). The installation type and quality also play an important role in meeting use requirements.

The points of attention related to the installation of reclaimed slabs do not fundamentally differ from those related to new slabs. In all cases, reference should be made to the European and national standards relating to the product (in particular the European standard for natural stone slabs for exterior paving EN 1341 and the standard for natural stone slabs for flooring and stairs EN

12058) and to the rules of practice in force (or implementation standards). It should be noted that some local reference guides on the installation of slabs already include the case of reclaimed slabs (for example: the Qualiroute standard developed in the Walloon Region, Belgium).

The following characteristics can be described and specified when drafting the technical requirements related to the delivery of a batch of reclaimed slabs:

→ **Batch composition.** The batch of reclaimed slabs consists of elements of the same format (square, rectangular, irregular, etc.), of the same geological nature or even of the same original use (interior use, area subject to frost, etc.). It is advisable to define one batch as a surface to be paved and of the same application. However, mixed slab batches may be suitable for less demanding applications.

→ **Format.** Depending on the installation, the slabs must have a greater or lesser dimensional stability (same dimensions and same thickness). While some particular formats (for example, cabochon tiles) require adapted paving layouts, other stone-setting is particularly suited to more irregular elements. For example :

→ **Hue.** By nature, natural stones have a wide variety of colours and appearances. Depending on usage requirements (for example, in the context of heritage renovation), it is possible to specify this characteristic by referring to a general hue or to a specific colour. During the installation, it is advisable to mix the stones of the different pallets in order to obtain a uniform flooring.

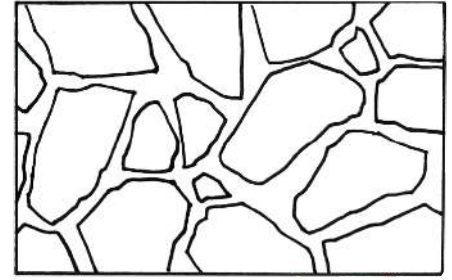

*Opus incertum: format allowing to work with any fragments of broken slabs.*

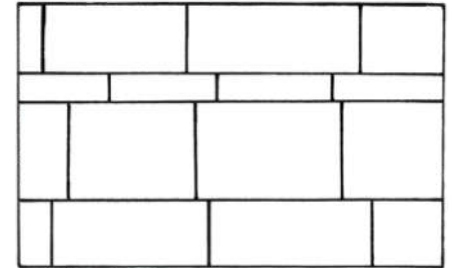

*Free length and variable width: format allowing to work with elements having a constant width and variable lengths (on a same row).*



Proposal for a floor layout that combines slabs and marble panelling © Rotor

### Think reversible!

Certain laying methods complicate or even prevent future recovery of stone flooring slabs. This is particularly the case with rigid installations where the slabs are bonded (mineral binders, synthetic fillers and resins) or sealed with cement mortars. In this sense, as soon as possible and with comparable performance, it is preferable to favour a flexible installation (flexible base, sand bed and sand joints, stabilised sand or from a bituminous emulsion) or an embedded installation using lime mortars or bastard mortars..





## Natural stone flooring slab

→ **Condition.** In addition to traces of mortar, paint and bitumen residues, reclaimed slabs may show minor alterations such as signs of surface wear, chips, light cracks, craters, light flaking, stains, leftover moss, etc. These deteriorations can influence the technical and aesthetic performance of the slabs, as well as their re-installation, but do not constitute a major obstacle to reclamation - except for very specific uses (see § "Characteristics and fitness for use").

The batch must not, however, contain any elements showing cracks or major damage compromising its solidity (e.g. stylolithic joints leading to the surface of limestone, deep cracks, etc.). The specifier should define the degree of imperfections tolerated with regard to the intended use and the installation conditions. He may particularly describe the degree of tolerance of the following elements:



Moss and algae residue



Splintering



Chipping



Scratching



Bedding layer residue



Deep cracks and splinters



Superficial cracking



Stylolithic joint

→ **Finish.** Depending on the requirements (functional and aesthetic) and the type of rock, specify the appearance of the visible face (rough, sawn, bush hammered, shot-peened, flamed, polished, softened, etc.), ask that it be identical for the whole batch and specify what fraction of the surface of the slab it concerns.

→ **Quantity.** Some suppliers may include surplus when the product is delivered if they are not able to guarantee the absolute uniformity of the characteristics mentioned above. This surplus can also be applied in the case of an on-site salvage scenario. It is generally advisable to provide a reserve stock of slabs in order to carry out subsequent repairs. Depending on the layout chosen, a greater or lesser percentage of margin will be necessary because of the cutting brought about (generally between 5 and 10%).

Most professional suppliers are able to ensure that delivered batches meet these requirements. A control test procedure based on a contractual sample and sampling upon receipt can be set up.

Most of the reclaimed building materials are sold as is. The conditions of sale may however contain special guarantees specific to the material. Some suppliers are able to indicate the origin of the material and/or provide documentation on the product purchased (for more information, see the *Introductory sheet*).

### Design tip!

In general, the integration of reclaimed stones in the project is greatly facilitated if we plan:

- a layout that tolerates slabs of various sizes.
- a composition strategy for the batches recovered: either by mixing the batches to create a random distribution of colour shades, or by assigning each batch of material to a particular space.
- a method of installation which allows working with slabs of various thicknesses. Indeed, it often happens that the batches of reclaimed stones are not graded.



**Characteristics and fitness for use**

By knowing the family or the type of stone present, it is generally possible to find its general characteristics (depending on the context). These indications are invaluable for studying the compatibility of the reclaimed stone for the intended use.

See for example: [www.febenat.be](http://www.febenat.be) ; [www.stonenaturelle.fr](http://www.stonenaturelle.fr) ; [www.pierreetisol.com](http://www.pierreetisol.com) ; [www.cstc.be](http://www.cstc.be) ; etc.

As an indication, the following table (Table 1) shows some of the known performances of some types of rock constituting stone flooring slabs which are frequently reclaimed. It is important to point out that each stone has its own characteristics and that two batches of flooring slabs of the same rock can however have quite different performances.

The harmonised European standard EN 1341 establishes the relevant characteristics for determining the fitness for use of natural stone slabs intended for exterior paving, and the standard EN 12058 defines the relevant characteristics of natural stone products as flooring and staircase slabs. Although detailed for new materials from the extractive and natural stone processing industry, these characteristics may prove useful in considering the specific case of reclaimed indoor/outdoor flooring slabs (Table 2).

**Tip!**

*If the performance is to be determined in the laboratory, a representative sample of the batch in question should be established. The number and dimensions of the samples to be taken depend on the type of test to be carried out. In order for the test results to be usable, the sampling procedure must be rigorous. A professional can assist you in this work to choose the samples and the tests to be carried out. For example, he will ensure that the properties of different samples subjected to identical stresses are assessed in order to obtain a representative mean value. The test procedures will be defined with regard to the previous and subsequent uses of the slabs.*

Table 1: Technical characteristics of the most common stones used in flooring slabs

	Bulk density (kg/m <sup>3</sup> )	Flexural strength(MPa)	Porosity	Wear resistance
<b>Sandstone</b>	1900 - 2700	3 - 14	little porous (0.5 to 25%)	++(+)
<b>Soft limestone (e.g. white stone)</b>	< 2500	2-17	porous (5 to 50%)	++
<b>Compact limestone (e.g. bluestone)</b>	> 2500	2-17	little porous (0.2 to 5%)	++
<b>Granite</b>	2400 - 3000	8 - 25	very little porous (0.2 to 2%)	+++
<b>Marble</b>	2600 - 2900	8 - 22	very little porous (0.2 to 2%)	++

Table 2: Characteristics to be assessed to determine the fitness for use of reclaimed natural stone slabs for indoor/outdoor flooring

Characteristics	Indoor	Outdoor	Comments
<b>Geological origin and petrographic description</b>	x	x	The reclaimed slabs come from building works that may have been made from batches of multiple origins. If it is possible to visually characterise the type of rock present, it is however more difficult to affirm with certainty that their geological origin is identical, unless there are records that allow it to be attested (for example: a certificate of origin, archival documents, etc.). This is all the more true for the batches made up of slabs of various origins.
<b>Geographical origin</b>	x	x	As with the geological provenance, information on the original geographic provenance of a batch of reclaimed slabs is difficult to certify with any certainty. On the other hand, we can deduce certain characteristics if we know where the slabs were removed. Intact and dismantled slabs in an area subject to strong freeze/thaw cycles are likely to show good frost resistance. Thus, in the absence of information on the original quarry, it may be useful to have information on the original use or the area where the slabs come from.
<b>Bulk density and open porosity</b>	x	x	<p>These characteristics are specific to each stone. The density [kg/m<sup>3</sup>] gives an indication of the degree of compactness of the stone. In general, the more compact a rock, the less porous it is.</p> <p>The open porosity of a stone [% by volume] corresponds to the proportion of pores connected to each other and accessible to water. This characteristic influences in particular the degree of resistance to stains and soiling. It does not directly affect its freezing (it is rather its capacity to return the absorbed water that matters at this level).</p> <p>This information can be estimated based on technical documentation relating to natural stones (see Table 1). If necessary, these characteristics can be measured more precisely by an identity test as defined by the test EN 1936.</p>



Characteristics	Indoor	Outdoor	Comments																
<b>Geometric characteristics</b>	x	x	<p>These characteristics can be found out by taking simple measurements. They are closely linked to the degree of sorting and cleaning of the reclaimed slabs as well as to the transformation operations undertaken on the material. In the case of slabs intended to be re-machined or re-cut, it is advisable to define with the supplier the dimensional tolerances applicable to each of the dimensions (width, thickness, length, etc.) the required stone-setting, the type of stone and the functionality of the works (these various aspects are described in standard EN 1341). The requirements in terms of flatness and straightness should also be detailed.</p> <p>In general, raw reclaimed slabs show irregularities in shape related to the original manufacture and the degree of wear.</p>																
<b>Tactility (for visually impaired people)</b>	x	x	<p>Tactility describes the surface relief of the slabs. If required, this feature can be achieved through mechanical finishes based on CEN/TS 15209.</p>																
<b>Flexural strength</b>	x	x	<p>The flexural strength <math>R_f</math> [MPa] is a mechanical characteristic which provides information on the capacity to resist bending forces in use. It varies according to the type of stone and is generally determined by means of bending tests (as per standard EN 12372).</p> <p>The flexural strength makes it possible to determine the admissible breaking load [kN] of the slabs, according to their dimensions, and to the following formula:</p> $P = \frac{R_f \times W \times t^2}{1500 \times L \times F_s} \quad \text{où} \quad P \quad : \text{ breaking load [kN]}$ <p style="margin-left: 40px;"><math>W, L, t</math> : width, length and thickness [mm]  <math>R_f</math> : flexural strength [MPa]  <math>F_s</math> : safety factor, generally <math>F_s = 1.6</math></p> <p>The thickness here is therefore a determining variable: since it is squared, a small variation can cause a big difference.</p> <p>In the case of roadside slabs, the applicable requirements can be summarised in the following table:</p> <table border="1" style="margin-left: 40px;"> <thead> <tr> <th>Recommended use</th> <th>Breaking load (kN)</th> </tr> </thead> <tbody> <tr> <td>decoration</td> <td>no requirement</td> </tr> <tr> <td>pedestrian use only</td> <td>&gt; 0.75</td> </tr> <tr> <td>pedestrian and cycling areas</td> <td>&gt; 3.5</td> </tr> <tr> <td>occasional access for light vehicles, garage entrances</td> <td>&gt; 6</td> </tr> <tr> <td>pedestrian traffic area, market places, occasional circulation of delivery/rescue vehicles</td> <td>&gt; 9</td> </tr> <tr> <td>pedestrian traffic area frequently used by heavy trucks</td> <td>&gt; 14</td> </tr> <tr> <td>roads and streets</td> <td>&gt; 25</td> </tr> </tbody> </table> <p>However, in the case of reclaimed slabs, it can be assumed that elements that have been subjected to high loads during their life will continue to meet similar or lower requirements. A detailed examination of the initial conditions of use therefore allows the flexural strength of reclaimed slabs to be assessed without any specific test measures.</p>	Recommended use	Breaking load (kN)	decoration	no requirement	pedestrian use only	> 0.75	pedestrian and cycling areas	> 3.5	occasional access for light vehicles, garage entrances	> 6	pedestrian traffic area, market places, occasional circulation of delivery/rescue vehicles	> 9	pedestrian traffic area frequently used by heavy trucks	> 14	roads and streets	> 25
Recommended use	Breaking load (kN)																		
decoration	no requirement																		
pedestrian use only	> 0.75																		
pedestrian and cycling areas	> 3.5																		
occasional access for light vehicles, garage entrances	> 6																		
pedestrian traffic area, market places, occasional circulation of delivery/rescue vehicles	> 9																		
pedestrian traffic area frequently used by heavy trucks	> 14																		
roads and streets	> 25																		
<b>Adhesion resistance (if bonding)</b>	x	x	<p>The adhesion strength and durability values depend on several important factors: the type of mortar/bonding, the surfaces to be bonded, the climatic conditions, etc.</p>																
<b>Direct overhead sound insulation</b>	x		<p>In general, the heavier a material (dense and thick), the better it insulates, especially against airborne noise. However, it is rare that one chooses a stone for reasons related to acoustics. If required, however, this characteristic can be determined in the laboratory according to the test method of EN 1936.</p>																





Characteristics	Indoor	Outdoor	Comments
<b>Thermal conductivity</b>	x		Thermal conductivity is defined as the amount of heat that passes through the material per unit of time and area. It depends on the voids present in the material. Generally speaking, the denser the stone, the better its thermal conductivity. If required (underfloor heating), this characteristic can be determined in the laboratory (according to the test method of EN 1745).
<b>Slippage</b>	x	x	<p>This feature influences the comfort and safety of users. It mainly depends on the roughness and texture of the surface. It can be assessed visually. The coarser it is, the more non-slip it is. This characteristic changes over time under the influence of the surface wear, the presence of dirt, the maintenance conditions, the slope, the density of the joints and the climatic context (rainfall). The in-depth evaluation of the slip resistance (managed by the EN 14231 test standard) may be relevant when the structure is intended for pedestrian and vehicles traffic. This standard further stipulates that embossed or cleaved squared slabs, with a surface roughness greater than 1 mm, meet the slip requirements without prior test measurements.</p> <p>In the case of reclaimed slabs, a specific finishing treatment adapted to the type of stone can be considered. Certain finishing treatments (flame treatment, for example) may be applied during use in order to meet the requirements in force.</p>
<b>Resistance to freezing/thawing (and de-icing salts)</b>		x	For an exterior application, the natural stone elements must be able to withstand freezing/thawing without their appearance or their mechanical characteristics being affected. The source and condition of a batch of reclaimed slabs can provide a useful guide to determining their resistance to freezing/thawing. Many old slabs are in fact likely to have withstood, during their first use, more freeze/thaw cycles than what is recommended by the test standard which allows this performance to be assessed (EN 12371). It is therefore important to find out about the geographical origin of the batch to ensure the original climatic conditions (for example, a batch coming from a continental climate in northern Europe will probably be suitable for an application in the Mediterranean climate of the South of France). Generally, less resistant slabs that have suffered frost damage will probably have been discarded during the sorting and cleaning steps.
<b>Thermal deformation</b>	x	x	Natural stone is subject to dimensional variations under the effect of temperature. This deformation is expressed in [mm/mK] by the coefficient of thermal expansion. In the case of slabs subjected to large temperature variations (exterior paving, paving in contact with underfloor heating, etc.), it may be relevant to determine its extent (EN 14581: 2005) in order to size the movement joints (width and spacing). In some marble and, to a lesser extent, some granites, the anisotropic thermal expansion of the stone can cause granular decohesion resulting in significant deformation of the slabs.
<b>Resistance to impact</b>	x	x	The resistance of a slab to the impact of a hard body depends on the characteristics of the stone but also on its installation system and its substrate. The test described in standard EN 14158: 2004 consists in dropping a steel ball on the slab installed in its real conditions of use. For reclaimed slabs, it is also possible to rely on the condition of the slabs still installed. If many slabs in the same room are broken, it can be assumed that even intact slabs are likely to break in turn. These slabs should not be extracted without keeping all the information on the condition of the batch.
<b>Wear resistance</b>	x	x	This durability characteristic depends on the type of stone, the intensity and type of traffic, the presence of abrasive particles and the maintenance conditions. If there is a test standard which allows this characteristic to be evaluated with precision (EN 14157 - Capon test), it can also be used for reclaimed slabs, by relying on the way in which they have withstood the demands of their first use. In general, granites and basalts are suitable for intense stress and are more resistant to wear than sandstones and limestones.



## Natural stone flooring slab

Characteristics	Indoor	Outdoor	Comments
<b>Susceptibility to staining</b>	x	x	<p>To assess this characteristic, we differentiate between internal staining caused by the reaction of certain constituents of the stone (metallic minerals or organic materials present in the stone), from accidental staining caused by contact with a potentially staining product for stone.</p> <p>Internal staining is above all a concern for the aesthetics of the material and it is therefore appropriate for the specifier to define the acceptable characteristics with regard to the intended use.</p> <p>The sensitivity to staining is also directly related to the porosity value of the stone. The higher the porosity, the more easily the stone absorbs liquids (and therefore pollution) and the more sensitive it is to staining. A porosity of less than 4% is generally satisfactory in order to limit the risks of soiling. It is also possible to visually identify the degree of soiling of the reclaimed slabs by observing the visible face of the unprocessed (sawn) elements. Specific surface treatments can also be recommended to improve this performance.</p>
<b>Reaction to fire</b>	x		<p>In accordance with Commission Decision 96/603/EC, natural stones are considered to belong to class A1 of reaction to fire (see EN 12 058 for exceptions). However, be careful with the use of filler sealants, which can affect this performance.</p>

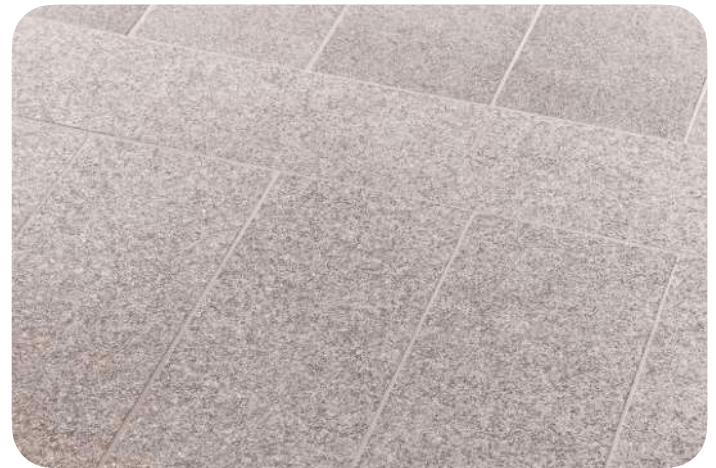

Reuse of Italian flamed granite slabs. Zonnige Kempen, Westerlo, (BE). © Rotor



Reuse of granite and Hainaut stone slabs of various sizes and shapes, recovered from the City of Paris warehouse. Square de la biodiversité, Paris (FR)  
© Perrine Henault, [Atelier NOUS](#)



## Natural stone flooring slab

### Availability

The professional market for reclaimed slabs is fairly developed. However, the size of the batches varies greatly from one offer to another, from a few dozen to several hundred square meters. It is recommended to check with professionals early enough in the event of a large order (several hundred square meters).

### Indicative prices (Excl. tax):

A non-exhaustive sampling of the reclamation market in North West Europe (Belgium, France, Great Britain and the Netherlands) made it possible to extract some indicative prices. These vary depending on the format, the size and type of stone, as well as the degree of sorting and cleaning requested.

- Sandstone slab = 50-150 €/m<sup>2</sup>
- Blue stone slab = 100-150 €/m<sup>2</sup>
- Slate slab = 50-200 €/m<sup>2</sup>
- White limestone slab = 120 - 300 €/m<sup>2</sup>
- Fragments of broken slab = 10-30 €/m<sup>2</sup>

### Find specialised businesses



[salvoweb.com](http://salvoweb.com)

[opalis.eu](http://opalis.eu)

### Embodied carbon (Cradle to gate - production A1-A3)

	kg CO <sub>2</sub> eq./m <sup>2</sup>	kg CO <sub>2</sub> eq./kg
OEKOBAUDAT (DE) database - Thinkstep individual data - Granite slabs *	31,8	0,6
OEKOBAUDAT (DE) database - Thinkstep individual data - Marble slabs *	16,3	0,3
OEKOBAUDAT (DE) database - Thinkstep individual data - Limestone slabs *	14,9	0,3

\* Indicative value for a façade cladding of 1 m<sup>2</sup>, 2 cm thick and with a basis weight of 52 kg/m<sup>2</sup>.

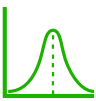

According to the sources and types of stone, reusing 100 m<sup>2</sup> of reclaimed natural stone flooring slabs prevents the production of ~ 1490 to ~ 3180 kg of CO<sub>2</sub> equivalent related to the manufacture of new slabs (production phase only). This corresponds to the amount of emissions caused by a small diesel car travelling a distance of ~ 9000 to ~ 19000 km.



Reuse of polished Belgian blue stone slabs. Vignette House, Auderghem (BE). Archi: Karbon' architecture & Urbanism © Giulia Frigerio

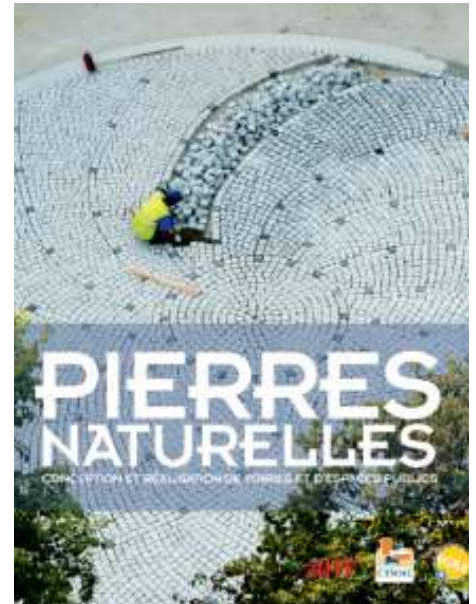

Pierres naturelles - Conception et réalisation de voiries et d'espaces (2019) (FRE), RGRA, 440 p., ISBN : 978-2-913414-52-5



**Disclaimer**

This sheet is intended for designers, specifiers and other members of construction project teams wishing to reuse this building material or product. It is part of a collection of sheets aimed at bringing together the available information to date that is likely to facilitate the reuse of building materials and products.

This sheet has been produced by Rotor vzw/asbl within the framework of the Interreg FCRBE project - Facilitating the Circulation of Reclaimed Building Elements, supported by the entire project partnership. Sources of information include the experience of reclamation dealers and involved project partners, lessons learned from exemplary projects, available technical documentation, etc.

The sheets have been produced between 2019 and 2021. As the reclamation sector is evolving, some information, notably regarding pricing and availability, may change over the time. When the text refers to European standards, it is up to the project team to refer, if necessary, to their national implementations and local specificities.

It is important to note that the information presented here is not exhaustive or intended to replace the expertise of professionals. Specific questions are always project related and should be treated as such.

The complete collection of sheets (including the introductory sheet) is freely available from different reference websites (a.o. [opalis.eu](http://opalis.eu), [nweurope.eu/fcrbe](http://nweurope.eu/fcrbe), [futureuse.co.uk](http://futureuse.co.uk)).

Non-exhaustive directories of dealers in reclaimed building materials are available on [www.opalis.eu](http://www.opalis.eu) and [www.salvoweb.com](http://www.salvoweb.com).

---

Interreg FCRBE partnership: Bellastock (FR), the Belgian Building Research Institute / BBRI (BE), Brussels Environment (BE), the Scientific and Technical Center of Building / CSTB (FR), Confederation of Construction (BE), Rotor (BE), Salvo (UK) and University of Brighton (UK).

The information contained in this document does not necessarily reflect the position of all the FCRBE project partners nor that of the funding authorities.

Unless explicitly stated otherwise, the content of these sheets is credited in the Creative Commons Attribution NonCommercial – Share Alike format (CCBY-NC-SA).



Unless explicitly stated, the images used in this document belong to © Rotor vzw/asbl or © Opalis. Any other image has been the subject of a systematic request for authorisation from their authors or rightful owners. When this request has not been answered, we assumed that there were no objections to the use of the image. If you feel that this interpretation is unreasonable, please let us know.



**Material description**

The shelves are referred to here as being natural stone panels, relatively thin and slender, and generally arranged on a horizontal plane. They are typically found at the foot of window frames (Figure 1), over certain fireplaces (Figure 2) or as radiator covers.

Like other natural stone materials, the shelves are interesting for reclamation: relatively resistant, they have beautiful finishes and are suitable for various transformations. These elements can be found at certain providers of architectural antiques and old materials, or even in classified ads. The stocks appear to fluctuate quite a lot.

In itself, it is possible to reuse these shelves for other purposes, for wall covering for example (see the sheet dedicated to natural stone wall covering slabs).

Reclaimed shelves have many variations. These relate in particular to the following characteristics:



Marble window shelf



Black marble fireplace shelf



Radiator shelf

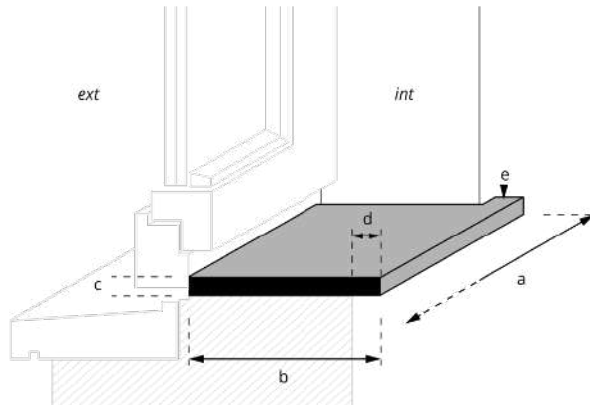

Figure 1. Geometry of stone window shelves

- a. Shelf length
- b. Shelf width
- c. Shelf thickness ~ 2 cm
- d. Overhang
- e. Lug

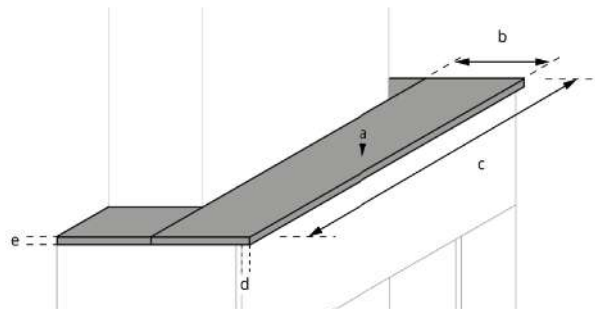

Figure 2. Geometry of stone fireplace shelves

- a. Mantelpiece
- b. Shelf width
- c. Shelf length
- d. Overhang
- e. Shelf thickness ~ 2 cm

→ **Geological nature.** Many types of rocks were used in the manufacture of shelves. Among the most common, we find marble, granite, blue stone or slate, in all their local variations.

→ **Dimensions.** Usually the reclaimed shelves have variable lengths, widths between 10 and 50 cm and fairly thin thicknesses of about 2 to 5 cm. Other dimensions are possible.

→ **Profiles.** Different shelf profiles can meet (see Figure 3), although rectangular formats are the most common. Among these, variations in angles (straight, rounded, lugged) and edges (straight, chamfered, rounded, etc.) are possible.

→ **Fixings.** Different fixing methods exist and are sometimes combined: embedding, interlocking, sealing using mortar or plaster, etc.

- Window shelves can be placed in the space left between the two walls or embedded in the masonry.
- The fireplace shelves are fitted to the fireplace mantel and/or fixed to the support.

In general, they have a slight protrusion (overhang) compared to the thickness of the wall or the fireplace mantel.

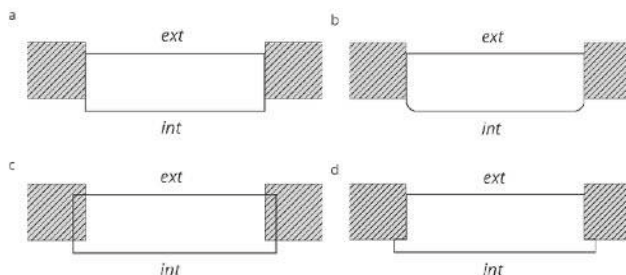

Figure 3. Commonly found window shelf profiles

- a. Rectangular shelf "loose" placed between 2 walls
- b. "Loose" shelf with rounded corners
- c. Shelf built into the masonry
- d. "Loose" shelf with "lugs"



## Natural stone shelf

→ *Appearance*. The diversity of the rocks is reflected in a wide range of colours: black, grey, beige, ochre, brown, pink, red, etc. The variations are almost endless! A specific vocabulary makes it possible to designate the encrustations of the stone (veins, grains, strata, flames, stains, etc.).

→ *Texture and finish*. Smooth finishes (honed or polished stone) are generally used to facilitate maintenance.



Variation in colour and grain of the stone shelves.



Wall covering from window shelves (BE). © Manugryson architecten

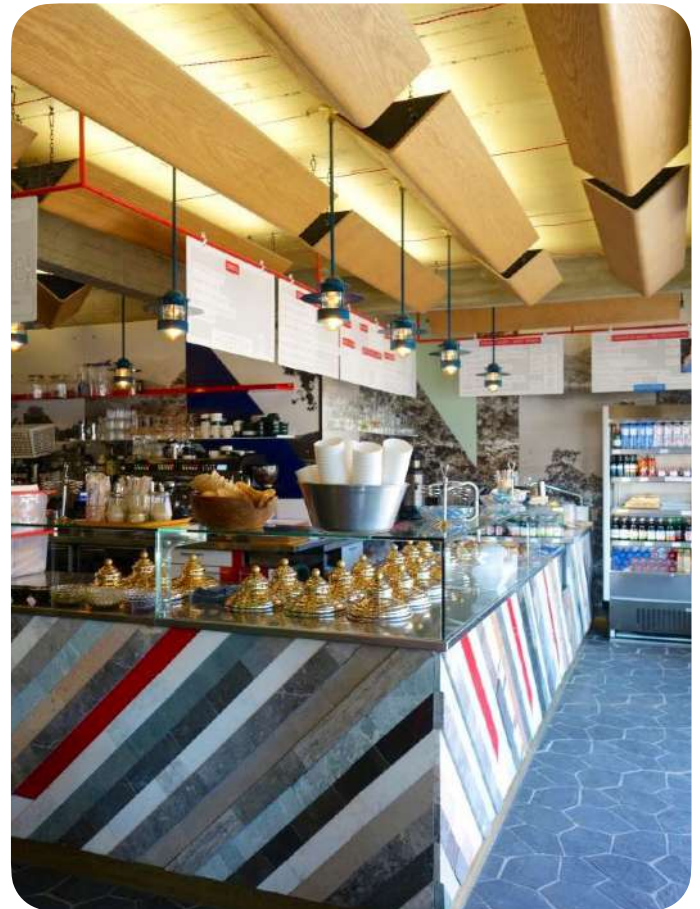

Reuse of window shelves, finishing of the Gaston Glacier counter. Brussels (BE) Interior by Lionel Jadot.





**Material reclamation**

**Shelves in good condition are a good candidate for reuse, either on-site or through the professional channels of material resellers. These professionals are usually able to ensure the smooth running of the following operations:**

→ *Disassembly test* (or expert opinion). A disassembly test makes it possible to ensure the feasibility and profitability of a removal. An “expert eye” generally makes it possible to estimate the interest of a batch based on plans, photos, historical documents or by an on-site visit. The focal points for shelves will be among others:

- the general condition of the batch and the laying method: condition of the stone, formats and dimensions, nature of the laying bed, characteristics of the joints, hanging and embedding mode, window frame fixing, etc.
- commercial interest, depending on the type of stone, period, style, quantity, etc.
- logistics arrangements: especially in terms of deadline, working time, handling, transport, etc.

→ *Removal*. The careful dismantling of shelves must ensure the safety of the workers and the integrity of the recovered elements. The risk of deterioration is high since the elements are thin and generally bonded and/or embedded. The rate of loss strongly depends on the type of rock, the original conditions of use, the type of installation (see *Figure 3*), the thickness of the slabs and the care taken in dismantling:

- if the shelves are laid “loose”, the expected recovery rate is around 75%;
- if the window shelves are inserted under the frame or under the cheeks of the window openings, the recovery rate is of the order of 50%.

The removal of a **window shelf** is done as follows:

- Cut the sealant between the window and the shelf using a cutter.
- Free the recessed ends: demolish the ceiling installation, the small masonry elements and any metal profiles.
- Use a crowbar to unseal the shelf from its horizontal support, taking care not to lift it too much so as not to break it.
- Slide the shelf into the horizontal position to extract it. This operation can be tricky depending on how deep the shelf is under the frame, the rigidity of the frame, the type of stone, etc. In addition, it is easier to recover the shelf if you do not want to preserve the other elements. Otherwise, it is advisable to first recover the frame before proceeding with disassembly.

The careful disassembly process is similar in the case of **fireplace shelves**. The recessed edges are released before proceeding with the lever loosening. The other stone cladding elements, constituting the mantelpiece, can also be recovered. Usually in marble, the plates are interlocked or fixed with copper staples and bonded to the substrate with plaster. It is advisable to dismantle the assembly respecting the interlocking direction, generally starting from the top.

**Radiator shelves** are often held in place by metal fittings and are easily retrieved.



*Release of shelf ends*



*Release of shelf ends*



*Removed elements*

**Dangerous substances**

*Some shelves may have been in contact with dangerous substances such as asbestos window sealants or other asbestos elements. In this case, removal should only be considered after the asbestos removal work.*



*Black marble fireplace*



*Dismantling the mantelpiece*



*Removed elements*



## Natural stone shelf

→ **Cleaning and sorting.** The shelves will be sorted by quality, colour, size and degree of cleaning. Cleaning with a brush and water may be considered to remove traces of plaster or fixing mortar as well as scraping off any sealant residue using a suitable blade, taking care not to scratch the surface. There are products to repair small cracks and breaks (mineral mortar, stone grafts, etc.). These can be considered for damaged shelves.

→ **Operations.** Most of the time, stone shelves can be reused as they are after a rough cleaning. In certain cases, additional operations on the material can be considered before its installation. For example :

- **Sawing:** the shelves can be sawn to make their dimensions consistent and facilitate their installation.
- **Cleaning and finishing:** the visible face of some more porous stones may be stained or have changed colour during use due to atmospheric pollution or the growth of mosses. Their restoration to original condition is not always possible. It depends on the depth of encrustation, which varies according to the type of pollution and the type of stone. It is advisable to contact a professional to know the compatible products and the appropriate treatment methods. Several techniques are possible: water polishing (different pressures and temperatures), use of chemicals (oxalic acid, polishing chemicals, polishers), mechanical cleaning (sanding, polishing, sand-blasting, projection of fine particles, micro-sanding , etc.) or even, in very specific cases, use of laser, latex or poultices.

The choice of a suitable cleaning technique will depend essentially on the following aspects: nature and hardness of the stone, fineness of its grain and other surface aspects, presence of alterations, type and degree of soiling, desired result.

→ **Storage and packaging.** The shelves are generally packaged and strapped to a pallet horizontally. Ideally, they are separated by wedging elements in order to limit the risk of damage. The wedges/separation wood must not be treated, be very dry and not contain tannins which could stain the stones. Metal straps should be avoided as there is a risk of staining the stone (rust). Ideally, the shelves are stored indoors because outdoor conditions can mar the surface appearance of some polished natural stones and compromise their reuse. The packaging must take into account the large mass of the elements. Appropriate means of transport and lifting are also required.

Reclaimed natural stone shelves are generally sold by batch or by piece. Most suppliers are able to provide indications on their main characteristics (type of rock, nominal dimensions and tolerances, finish, intended applications) and, in certain cases, their origin.



Cutting stone elements



Pallet packaging



Vertical storage



## Applications and installation

**Reclaimed shelves can be reused in their original function or reused for other purposes. The thinness of the elements makes it possible to apply them as wall covering, as decorative wall lights or even as a worktop.**

The majority of the points of attention related to the installation of reclaimed stone shelves are similar to those linked to new shelves - in particular, and in a non-exhaustive way: type and dimensions of the elements, type of laying bed, type of grouting, finish, softening of edges, etc.

It is up to the designers to rely on the regulations in force, the rules of practice and the national and European standards relating to natural stone products. Furthermore, adequate installation requirements must be specified to cover the wide variety of possible applications of reclaimed shelves.

In general, finding a batch with very specific characteristics can be complicated. It is often preferable to identify one or several batches of raw reclaimed shelves and to consider additional treatment and processing operations. The expertise of professionals can be invaluable in this regard.

The following characteristics can be described and specified when drafting the technical requirements related to the delivery of a batch of reclaimed shelves:

→ **Format.** The identified batch must correspond to the constraints of the desired dimensions. Shelves with defects such as broken corners may be used provided that a rectangle corresponding to the surface of the desired shelf can fit into the intact part. Depending on the case, it is also possible to provide for the possibility of covering a significant length in several pieces. This makes it possible to value intact fragments of smaller size.

→ **Nature of the stone.** The choice must correspond to the intended use, in particular in terms of resistance to acids, absorption (especially for kitchen worktops). It is possible to combine the types of stones but the installation can be more complicated.

→ **Hue.** By nature, natural stones have a wide variety of colours and appearances. Depending on usage requirements (for example, in the context of heritage renovation), it is possible to specify this characteristic by referring to a general hue or to a specific colour.

→ **Condition.** In addition to traces of mortar, plaster, paint and mastic residues, reclaimed shelves may show minor alterations such as signs of surface wear, chips, scratches, light cracks, stains, etc. These deteriorations can influence the technical and aesthetic performance of the shelves, as well as their re-installation, but do not constitute a major obstacle to reclamation (see § "Characteristics and fitness for use"). Where appropriate, certain surface treatments, or even cutting, can make it possible to correct these alterations. It is up to the designer/specifier to define the degree of imperfection tolerated, according to the defined use and the installation conditions, by specifying the degree of acceptable alterations (for example: surface scratching tolerated on the visible face, broken corners and edges tolerated on non-visible parts, etc.). However, the batch must not contain any elements showing cracks or major damage compromising its solidity on the useful part.

→ **Texture et finish.** Depending on the requirements (functional and aesthetic) and the type of rock, the appearance of edges, corners (e.g. chamfered, rounded, etc.) and the surface (e.g. polished, honed, rough, etc.) should be specified. Window shelves are usually polished or softened at the outset.

→ **Quantity.** Some suppliers may include surplus when the product is delivered if they are not able to guarantee the absolute uniformity of the characteristics mentioned above. This surplus can also be applied in the case of an on-site salvage scenario because some shelves will probably be damaged during disassembly.

Most professional suppliers are able to ensure that delivered batches meet these requirements. A control test procedure based on a contractual sample and sampling upon receipt can be set up.

Most of the reclaimed building materials are sold as is. The conditions of sale may however contain special guarantees specific to the material. Some suppliers are able to indicate the origin of the material and/or provide documentation on the product purchased (for more information, see the *Introductory sheet*).



Sealant and cutting for housing the shelf  
© Frédéric Uyttenhove



Scratches on the shelf surface



Shelf cracking in its centre

### Design tip!

To increase the chances of meeting the offer available on the reclamation market, the designer/specifier can choose to combine different batches of stone (formats, type of stone, original use, etc.) and distribute them in an organised manner in the building. For example, plan a uniform batch of shelves per space or per floor.

The designer/specifier can also play on a patchwork principle, in particular for the use of shelves as wall cladding. Different batches can be grouped together and cut into different sizes. This flexibility in the supply and in the choice of layout makes it possible to cover much larger areas.





**Characteristics and fitness for use**

There is no harmonised standard specific to stone shelves, but several standards and test methods make it possible to determine the properties relating to natural stones (EN 12407 - Petrographic examination, EN 1936 - Determination of real density and apparent density, and of total and open porosity, EN 12371 - Determination of frost resistance, etc.). Although they relate to new materials, these documents can be useful in determining the relevant characteristics (depending on the project) related to the reclamation of shelves.

For a different use of shelves as wall cladding, please refer to the characteristics and fitness for use described in the sheet dedicated to natural stone wall cladding slabs.

<b>Characteristics</b>	<b>Comments</b>
<b>Geological origin and petrographic description</b>	The reclaimed shelves come from works that may have been made from batches of multiple origins. If it is possible to visually characterise the type of rock present, it is however more difficult to affirm with certainty that their geological origin is identical, unless there are records that allow it to be attested (for example: a certificate of origin, archival documents, etc.). This is all the more true for the batches made up of elements of various origins.
<b>Bulk density and open porosity</b>	<p>These characteristics are specific to each stone. The density [kg/m<sup>3</sup>] gives an indication of the degree of compactness of the stone. In general, the more compact a rock, the less porous it is.</p> <p>The open porosity of a stone [% by volume] corresponds to the proportion of pores connected to each other and accessible to water. This characteristic influences in particular the degree of resistance to stains and soiling. It does not directly affect its freezing (it is rather its capacity to return the absorbed water that matters at this level).</p> <p>This information can be estimated based on general technical documentation relating to natural stones. If necessary, these characteristics can be measured more precisely by an identity test as defined by the test EN 1936.</p>
<b>Geometric characteristics</b>	These characteristics can be found out by taking simple measurements. They are closely linked to the degree of sorting and cleaning of the reclaimed slabs as well as to the transformation operations undertaken on the material. In the case of shelves intended to be re-machined or re-cut, it is advisable to define with the supplier the dimensional tolerances applicable to each of the dimensions (width, thickness, length, etc.) the type of stone and the functionality of the works. The requirements in terms of flatness and straightness should also be detailed.
<b>Flexural strength</b>	The flexural strength R <sub>f</sub> [MPa] is a mechanical characteristic which provides information on the capacity to resist bending forces in use. It varies according to the type of stone and is generally determined by means of bending tests as per standard EN 12372. This characteristic can be checked in the event of a large overhang of the shelves.
<b>Thermal deformation</b>	Natural stone is subject to dimensional variations under the effect of temperature. This deformation is expressed in [mm/mK] by the coefficient of thermal expansion. In the case of shelves subject to large temperature variations (shelves above a radiator, a fireplace, etc.), it may be relevant to determine its extent (EN 14581: 2005). For certain marbles and, to a lesser extent for certain granites, the anisotropic thermal expansion of the stone can cause granular decohesion leading to significant deformation of the shelves.
<b>Resistance to impact</b>	The impact resistance of a hard body depends on the characteristics of the stone but also on its installation system and its substrate. The test described in standard EN 14158: 2004 consists in dropping a steel ball on the element installed in its actual conditions of use. For reclaimed shelves, we can also rely on the condition of the shelves still installed. If many shelves subjected to similar stresses are broken or deteriorated, it can be assumed that even intact shelves are liable to break in turn. These shelves alone should not be extracted without keeping all the information on the condition of the batch.
<b>Reaction to fire</b>	In accordance with Commission Decision 96/603/EC, natural stones are considered to belong to class A1 of reaction to fire (see EN 12 058 for exceptions). However, be careful with the use of filler sealants, which can affect this performance.



Characteristics	Comments
<b>Susceptibility to staining</b>	<p>To assess this characteristic, we differentiate between internal staining caused by the reaction of certain constituents of the stone (metallic minerals or organic materials present in the stone), from accidental staining caused by contact with a staining product.</p> <p>Internal staining is first and foremost an aesthetic concern for the material and it is therefore appropriate for the project developer to define the acceptable characteristics with regard to the intended use.</p> <p>The sensitivity to staining is also directly related to the porosity value of the stone. The higher the porosity, the more easily the stone absorbs liquids and pollution, the more sensitive it is to staining. A porosity of less than 4% is generally satisfactory in order to limit the risks of soiling. It is also possible to visually identify the degree of soiling of the reclaimed slabs by observing the visible face of the unprocessed (sawn) elements. Where appropriate, there are surface treatments to improve this performance by slowing the infiltration of greasy substances into the stone's pores.</p>

### Availability

Some vendors of architectural antiques or stone items may have these types of items in stock. There are also shelf models on the material resale sites between individuals but generally in small quantities (<10 pieces).

### Indicative prices (Excl. tax):

A non-exhaustive sampling of the reclamation market in North West Europe (Belgium, France, Great Britain and the Netherlands) made it possible to extract some indicative prices. The price of the shelves varies greatly from one offer to another, it depends on the availability of the format, the type of stone, as well as the degree of sorting and cleaning required.

- Window shelves in natural stone ~ 40 -110 €/m<sup>2</sup>
- Cutting services: ~ 40 €/h

### Find specialised businesses



[salvoweb.com](http://salvoweb.com)

[opalis.eu](http://opalis.eu)

### Embodied carbon (Cradle to gate - production A1-A3)

	kg CO <sub>2</sub> eq./m <sup>2</sup>	kg CO <sub>2</sub> eq./kg
OEKOBAUDAT (DE) database - Thinkstep individual data - Granite slabs *	31,80	0,6
OEKOBAUDAT (DE) database - Thinkstep individual data - Marble slabs *	16,3	0,3
OEKOBAUDAT (DE) database - Thinkstep individual data - Limestone slabs *	14,9	0,3

\* Indicative value for a façade cladding of 1 m<sup>2</sup>, 2 cm thick and with a basis weight of 52 kg/m<sup>2</sup>.

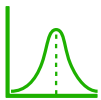

According to the sources and types of stone, reusing 100 m<sup>2</sup> of reclaimed natural stone shelving prevents the production of ~1490 to ~3180 kg of CO<sub>2</sub> equivalent related to the manufacture of new shelving (production phase only). This corresponds to the emissions caused by a small diesel car during a trip of ~ 9 000 to ~ 19 000 km.



# EQUIPMENT



- Toilet bowl
- Suspended urinal
- Washbasins (and slop sinks) for individual and collective use
- Cast iron radiators
- Sheet steel, stainless steel and aluminium radiators

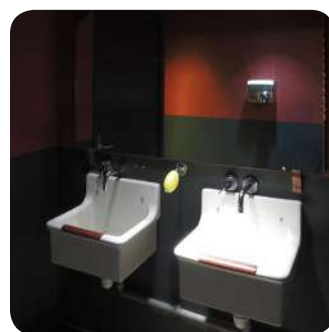



**Disclaimer**

This sheet is intended for designers, specifiers and other members of construction project teams wishing to reuse this building material or product. It is part of a collection of sheets aimed at bringing together the available information to date that is likely to facilitate the reuse of building materials and products.

This sheet has been produced by Rotor vzw/asbl within the framework of the Interreg FCRBE project - Facilitating the Circulation of Reclaimed Building Elements, supported by the entire project partnership. Sources of information include the experience of reclamation dealers and involved project partners, lessons learned from exemplary projects, available technical documentation, etc.

The sheets have been produced between 2019 and 2021. As the reclamation sector is evolving, some information, notably regarding pricing and availability, may change over the time. When the text refers to European standards, it is up to the project team to refer, if necessary, to their national implementations and local specificities.

It is important to note that the information presented here is not exhaustive or intended to replace the expertise of professionals. Specific questions are always project related and should be treated as such.

The complete collection of sheets (including the introductory sheet) is freely available from different reference websites (a.o. [opalis.eu](http://opalis.eu), [nweurope.eu/fcrbe](http://nweurope.eu/fcrbe), [futureuse.co.uk](http://futureuse.co.uk)).

Non-exhaustive directories of dealers in reclaimed building materials are available on [www.opalis.eu](http://www.opalis.eu) and [www.salvoweb.com](http://www.salvoweb.com).

---

Interreg FCRBE partnership: Bellastock (FR), the Belgian Building Research Institute / BBRI (BE), Brussels Environment (BE), the Scientific and Technical Center of Building / CSTB (FR), Confederation of Construction (BE), Rotor (BE), Salvo (UK) and University of Brighton (UK).

The information contained in this document does not necessarily reflect the position of all the FCRBE project partners nor that of the funding authorities.

Unless explicitly stated otherwise, the content of these sheets is credited in the Creative Commons Attribution NonCommercial – Share Alike format (CCBY-NC-SA).



Unless explicitly stated, the images used in this document belong to © Rotor vzw/asbl or © Opalis. Any other image has been the subject of a systematic request for authorisation from their authors or rightful owners. When this request has not been answered, we assumed that there were no objections to the use of the image. If you feel that this interpretation is unreasonable, please let us know.



## Toilet bowl

### Product description

**The fairly trivial nature of their use and their ubiquity in the built-up environment should not obscure the inherent complexity of flush toilet systems. They come in many variations, with respective specificities, which must be taken into account when considering their reclamation. The most common models are:**

→ *floor-standing bowls* with adjoining or separate cistern: the constituent elements are accessible, which simplifies any repairs. They are usually mechanically fixed to the floor and a seal provides hygienic closure. Depending on the case, the cistern is in glazed sanitary ceramic (glaze on the outside and/or inside) or in synthetic material. Older models can also be made of cast iron or enamelled sheet metal.

→ *suspended bowls*: attached to a vertical support frame, generally camouflaged in a load-bearing wall (surface-mounted) or a partition wall (universal or self-supporting system). A control plate is used to activate the flushing mechanism. Cleaning the floor is easier.

Flush toilets present a high degree of technicality. Their general good functioning depends on the good functioning of all their parts. This implies paying attention to the good condition of each part and each mechanical device (in particular the filling and emptying systems but also the various gaskets, the flange, etc.). If necessary, some parts can be repaired or must be replaced with new parts.

Most reclaimed toilet bowls have a *rim* (folded over at the top) integrated into the ceramic, rarely glazed on the inside, and provided with perforations around the entire perimeter of the bowl. Some contemporary bowls have rimless rinsing technology, which is more hygienic, which improves cleanability and limits scaling.

Toilets are only a small part of a large system of pipelines and infrastructure providing water supply and wastewater management. This implies special attention to the connections and joints between all the elements in order to ensure the correct functioning of the assembly. For toilets, this particularly affects drain sleeves and supply taps, but also the issue of emptying volumes. This involves correctly anticipating the connections and possibly planning the use of new plumbing parts.

The installation of toilets is governed by national and European standards relating, among other things, to emptying volumes, the dimensions of the water connection and drainage, water consumption, installation procedures. However, these have changed little over the past 20 years. Therefore, it can be assumed that toilet systems installed less than 20 years ago will broadly meet current requirements. In all cases, it is necessary to ensure this and, if necessary, to provide for the necessary adaptations.

Material deposits and the visibly worn character of a toilet also influence the appraisal of future users. This equipment refers in a particularly sensitive way to the concepts that users have on hygiene and personal comfort. Fortunately, cleaning processes often make it possible to give this sanitary equipment a second life.

More broadly, reclaimed toilets have great advantages! The maintenance possibilities and durability of ceramic elements explain their durability and their presence on the reclamation market.

This sheet proposes addressing these issues, focusing on recent toilet systems (late 20th - early 21st century) including glazed sanitary ceramic or vitreous china bowls (or, occasionally, stainless steel or synthetic materials).



*Floor-standing toilet with adjoining cistern*



*Floor standing toilet with separate cistern*



*Suspended toilet*



**Product reclamation**

**Often easily removable, toilet bowls are good candidates for reuse, either on-site or through the professional channels of material resellers. These companies rarely just specialise in sanitary equipment, but integrate them into a wider range of products.**

→ *Potential assessment*: An “expert eye” generally makes it possible to estimate the potential for reclamation during an on-site visit or based on photos and technical information relating to the model, manufacturer, quantities, dimensions, etc. The points for consideration are among others:

- general condition: are the devices damaged (cracks, splits, fissures, scratches, etc.)? *A cracked device must not be reclaimed.* Is the equipment clogged (limescale, mould)? What is the cistern condition and capacity?
- condition of accessories: is the flushing mechanism functional? Is it cleanable/replaceable? If it is a suspended toilet, can the support frame be salvaged or replaced? What is the condition of the toilet seat, seals, etc.?
- Commercial interest, depending on model, quantity, resale potential, ease of maintenance, etc.;
- logistical arrangements, including deadlines, handling, organisation of transport, etc.

→ *Removal*. careful dismantling should aim to ensure the integrity of the installation, the equipment and its accessories whose reclamation is being considered. If the installation is still supplied with water, it is advisable to carry out a pre-cleaning. It is then necessary to cut off the power supply (shut-off valves or general supply) before proceeding with disassembly. If they are recovered, the functional accessories (cisterns, seats, support frames, etc.) must be correctly dismantled and listed. The seats can be held in place and secured with adhesive tape to prevent them from moving during transport. It is advisable to document the fixing principle of specific elements in order to facilitate their subsequent installation. Once dismantled, the bowls and cisterns will be properly emptied, sorted by qualities, colours and dimensions and packaged in such a way as to avoid knocks and breakage.

→ *Storage*. it is advisable to place the bowls so that their installation face rests on a flexible support, to avoid spillover from the pallets, and to provide dividers, strapping and possibly a packaging film. Once cleaned and ready to be used, it is preferable to store the elements away from water and dust.

*Checking the condition of the glaze*

*It is possible to test the condition of the glaze layer using an alcohol marker: if it is easily erased, the glaze is still in good condition, otherwise the glaze has probably become 'porous'.*

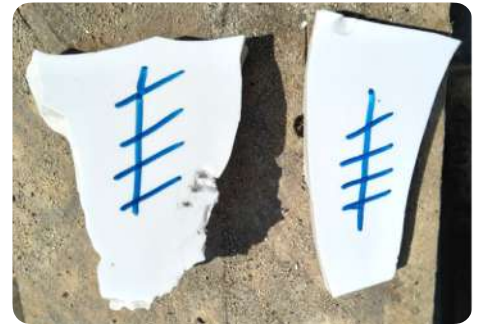

*'Porous' glaze (left) vs glaze in good condition (right)*



*Removal of toilet bowls for reclamation*







## Toilet bowl

→ **Treatments, maintenance and cleaning.** During use, toilets can undergo various forms of deterioration. One of the most common is the formation of material deposits which become embedded more or less deeply in the bowl and in the various parts with which these materials come into contact. This is particularly the case with scale, present in mains water and which, when it accumulates in large quantities, can lead to malfunctions.

→ Recent reclaimed toilet bowls are generally sold without any treatment other than surface cleaning with soapy water or even bleach. A descaler or vinegar are also sometimes used to remove the most visible scale.

→ Some professionals offer deep cleaning and disinfection of ceramic equipment (mainly suspended bowls), in order to remove tough deposits (limescale, mortar, paint, putty, etc.). After removing the metal and synthetic accessories, the devices are soaked in a specific acid solution, before being pressure washed and then rinsed. Because of its additional cost, this process is especially interesting for mid-range and top-of-the-range bowls, with a rim.

→ If superficial blows affect the glaze layer, it is possible to carry out spot repairs using a specific product. Ready-to-use kits are readily available on the market.

→ In all cases, it is advisable not to use abrasive products or metal objects to remove dirt, as this may damage the surface layer.



*Dirty suspended bowls*



*Scaling of the rim and obstruction of the flushing orifice holes*



*Scaling of the flushing mechanism*

→ **Transport and delivery.** the necessary precautions must be taken during transport and delivery in order to limit knocks and scratches (interlayer protection, corner protectors, strapping of pallets, etc.).

It is advisable to involve specialised professionals to ensure the smooth running of these operations.

### → Professional cleaning process



*Phase 1: soaking the elements in a specific acid bath*



*Phase 2: Pressure rinsing*



*Phase 3: Packaging*



### Applications and installation

**In principle, the recycling of reclaimed toilet bowls is no different from that of new toilets. It must meet the same use requirements, in particular - depending on the case - with regard to the properties and condition of the support (floor or wall), the installation height, use by people with reduced mobility, products and techniques for laying and grouting, connections and plumbing, waterproofing, taps, wastewater disposal, etc. In all cases, reference should be made to the European and national standards relating to the product (i.e. EN 997 and EN 14055), and to the rules of practice in force (or implementation standards).**

To facilitate the integration of reclaimed elements, the specifier takes care to formulate his expectations with regard to the following characteristics.

→ *Types and dimensions* of equipment. For example, the *drain* outlet of the bowl can be horizontal (rear or side) or vertical. Leaving some latitude on the dimensions generally makes it easier to find a lot on the reclamation market.

→ *Condition and degree of wear accepted*. It is important that the bowls do not have any major cracks or breaks that could damage their sealing. Depending on the case, on the other hand, traces of surface wear, light traces of limescale, minor stains are acceptable.

→ *Flushing volume*. Some contexts require specific performance in this regard. The current standard is to provide a general volume of 6 litres and a reduced flushing system of 3 litres. In general, it is interesting to seek to reduce the consumption of water in the toilets. In some cases, it is possible to replace the flushing mechanism or even the entire cistern of older equipment, which no longer meets these requirements. There are professional devices equivalent to the low-tech principle of the brick or the full bottle placed in the tank. It is however a question of ensuring the feasibility and the appropriateness of such an operation - in particular by taking into account the diameter and the slope of the downstream pipes. Where applicable, this involves describing precisely the operations expected in the specifications.

→ *Accessories*. Clearly specify in the specifications all the elements which, if applicable, must be provided by the company to replace or adapt existing toilet systems. Among the parts likely to be delivered as new, we can mention: seat, cistern, cistern cover, support frame, control plate, flushing mechanism, float valve, bell and bell basin, pull or push button, gasket seals (cistern, bell, drain, etc.), flush elbow, supply valve, etc. For each accessory, it is a question of ensuring compatibility with the existing system. This step is facilitated when the technical documentation is available. Some accessories are sometimes available from professional reclamation dealers. For the more recent models, most professional sanitary ware dealers are able to offer compatible accessories. As an example, some manufacturers of new toilets recommend the replacement of the toilet seat, the flushing mechanism and the float valve every 5 years, and the replacement of the seals after 10 years.

Most of the reclaimed building products are sold as is. The conditions of sale may however contain special guarantees specific to the product. Some suppliers are able to indicate the origin of the product and/or provide documentation on the product purchased (for more information, see the introductory sheet). Generally, it is also possible to find the manufacturer's technical documentation using the make and model number if the equipment is recent enough.



*Crackling or crazing* is the phenomenon responsible for the appearance of a set of hairline cracks in the glaze. These can lead to the penetration of liquids inside the fissure, causing the appearance of lasting stains and causing the development of pathogens. It is therefore advisable to discard equipment with this defect.

#### *Design tip!*

*To increase the chances of meeting the offer available on the reclamation market, the specifier can choose to accept several different batches and distribute them in an organised manner in the building. For example, plan for a uniform batch per floor.*





**Characteristics and fitness for use**

A large number of harmonised European standards and national standards establish performance requirements relating to the various constituent parts of a toilet system (bowl, cistern, flushing valves, support frame, etc.). We focus here on recent toilet bowls and cisterns (~ 20 years), drawing inspiration from the characteristics established by the harmonised European standards EN 997 ( WC bowls and bowls with adjoining cistern with integrated siphon ) and EN 14055 ( Flush cisterns for toilets and urinals ). Although itemised for new materials, their content may prove useful in considering the reclamation of toilet systems.

Several performances associated with reclaimed toilets can be assessed while still installed (before dismantling). This situation is rare, and any adaptations (for example: replacing a 6 or 9 litre cistern with a low water consumption model or modifying the flushing mechanism) can greatly affect the performance of the equipment.

To meet the standards of use, it is recommended to opt for recent reclaimed sanitary equipment (less than 20 years old), and for which no major adaptation is to be considered. In fact, the regulations applying to sanitary facilities have changed little in recent years. For example, sanitary facilities in office buildings often meet these criteria. It is therefore easier to find technical documentation and thus validate their performance.

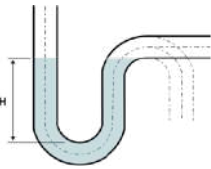
Please note the existence of specific standards dedicated to flush valves (EN 14124, EN 12541, EN 1509). Support frames for suspended toilets are not subject to harmonised standards. In general, the reclamation of these accessories is rather rare and should be considered based on the advice of a professional sanitary ware fitter.

Characteristics	Comments
<b>Cistern capacity and flush volume</b>	<p>The cistern capacity and the flush volume determine the amount of water released during operation. To reduce water consumption, the standards on toilet facilities evolved in the late 20 th century. The capacity of the tank has been reduced (max 9 litres) and flush-saving systems have appeared (3.5 to 6 litres in full flush and 2 to 4 litres in reduced flush). These modifications were accompanied by technological developments in the design of bowls and flushing mechanisms.</p> <p>In the absence of documentation, it is possible to approximate these volumes for toilets through experimenting with volumes.</p> <p>If necessary, it is possible to provide for the replacement of cisterns and flushing mechanisms, or even the switch to direct flush (without cistern) of an older toilet system. This operation must, however, take into account the following parameters: flushing flow rate, flushing efficiency, compatibility of the elements, overflow flow rate, inlet flow rate and pressure, slope and dimensions of the discharge pipes, shape and design of the bowl , national and regional regulations depending on the drainage network in place, etc.</p>
<b>Height of the water seal</b>	<p>The water seal is a hydraulic plug which remains in the siphon after rinsing in order to prevent the rise of odours coming from the drainage pipes. The height of the water seal must not be less than 50 mm. This characteristic can be evaluated under conditions of use.</p> <div style="display: flex; justify-content: space-around; align-items: center;">   </div>
<b>Functional characteristic - flushing efficiency</b>	<p>Flushing must be effective on the interior walls of the bowl. A visual inspection when installed makes it possible to assess this performance. For bowls with a rim, it should be ensured that the holes have not been blocked by scale. If necessary, specific cleaning is then recommended.</p> <p>Flushing must not cause any splashing to the outside of the bowl. It must allow the evacuation of liquid and solid residues without overflowing out of the bowl.</p> <p>The good quality of the flushing can be ensured by testing with particles of sand, paper or coloured liquids in a working bowl (as described in the EN 997 standard).</p>
<b>Functional characteristic - water absorption</b>	<p>Reclaimed sanitary ceramic toilet bowls must not absorb water. The presence of cracks, chips or signs of crazing in parts of the glaze that are in contact with water negatively influence this performance.</p> <p>This characteristic can be assessed by visual inspection of the functional surfaces of the bowls, using an appropriate light source. Some imperfections can be repaired.</p> <p>Experience shows that stainless steel bowls generally meet these requirements.</p>





Characteristics	Comments
<b>Functional characteristic - load resistance</b>	<p>This characteristic mainly concerns suspended equipment. It is possible to test it when installed by applying a static load to it (e.a. load of 150 to 400 kg for 1 hour). The bowl and cover must not crack, collapse or show any permanent deformation.</p> <p>Experience shows that sanitary ceramic free-standing toilet bowls which show no defect after their first use can be presumed to meet this requirement.</p>
<b>Sealing</b>	<p>The seal concerns the connections, the fixings and the drain valve (bell). A detailed visual inspection of the installed equipment makes it possible to assess this performance. If necessary, the replacement of certain faulty parts is possible.</p>
<b>Valve reliability</b>	<p>The float valve must supply the cistern when it is empty and shut off when the nominal volume is reached. Special specifications are applicable to the flush valve (inlet pressure, non-return valve, watertightness, inlet flow, materials, operating endurance, etc.). These parameters are difficult to check on reclaimed equipment.</p> <p>The main consequence of a failure of the float valve is to waste water (continuous flushing). This can be detected with the naked eye, by the ear (a seized mechanism emits a whistle) or by monitoring consumption. Most common failures can be corrected by cleaning the system or replacing failed parts (especially gaskets).</p>
<b>Seat</b>	<p>For bowls that no longer have their original seat and cover, or if these are too damaged, it is advisable to replace this part with a compatible model, possibly fitted with a slow closing system.</p> 
<b>Acoustic performance</b>	<p>The support frames may have polystyrene panels to limit the noise created through flushing. The design and installation of the equipment, valves and piping also influence the sound level of the installation.</p>
<b>Cleanability - chemical resistance</b>	<p>The surface of sanitary equipment must be resistant to common chemicals and cleaning products. Experience shows that bowls made of sanitary ceramic and stainless steel meet this requirement. Note that bleach (and chlorine products in general) is not recommended for cleaning stainless steel equipment.</p>



Chiro Itterbeek (BE) © Rotor



Bureaux de VLA-architecture (BE) © Sophie Boone



**Availability**

Ceramic toilets are a very common product in the reclamation market. However, availability depends on the quantities required. As an example:

Frequent	Batch of 1 piece
Occasionnal	Batch of 2 to 20 identical pieces
Rare	Batch of > 20 identical pieces

**Find specialised businesses**



[salvoweb.com](http://salvoweb.com)

[opalis.eu](http://opalis.eu)

**Indicative prices (Excl. tax)**

Random sampling of the reclamation market in Western Europe (Belgium, France, Great Britain and the Netherlands) made it possible to extract some indicative prices. These vary depending on the models, materials and original manufacturer. Prices for private customers.

→ *Supply price:*

- Standing toilet + cistern: 15 to 150 € / item
- Suspended toilet + support frame: 100-130 €/unit

→ *Removal cost:* around 35-50 €/unit

→ *Specific cleaning service:* 10-20 €/unit

However, the replacement of missing or defective parts should also be budgeted for.

Even taking into account these operations specific to reclamation logic, toilet equipment is generally competitive with new products, in particular for mid-range and high-end models.

**Dangerous substances and precautions**

To our knowledge, no hazardous material is likely to be present in reclaimed toilet equipment.

**Embodied carbon (Cradle to gate - production A1-A3)**

	kg CO <sub>2</sub> eq./PU
INIES database (FR) – Generic data *	173
AFISB (French Association of Bathroom Industries) - Collective declaration **	79.2
AFISB (French Association of Bathroom Industries) - Collective declaration ***	55.1

\*Indicative value for PU (Product Unit) = standard range ceramic (vitreous porcelain) toilet pack (bowl and cistern) with a reference lifespan of 20 years. Mechanism and seat included.

\*\* Indicative value for PU (Product Unit) = standard range ceramic (vitreous porcelain) toilet pack (bowl and cistern) with a reference lifespan of 20 years. Drain pipe, shut-off valve, mechanism, float valve, seat, gaskets and fixing screws included.

\*\*\* Indicative value for PU (Product Unit) = standard range suspended toilet (without support frame) in ceramic (vitrified porcelain) for a reference lifetime of 20 years. Drain pipe, shut-off valve, mechanism, float valve, seat, gaskets and fixing screws included.



According to the sources, reusing a standard range toilet bowl prevents the equivalent production of ~ 55 to ~ 174 kg of CO<sub>2</sub> related to the manufacture of new equipment (production phase only). By way of comparison, this corresponds to the emissions caused by a small diesel car during a trip of ~ 330 to ~ 1040 km.

**Disclaimer**

This sheet is intended for designers, specifiers and other members of construction project teams wishing to reuse this building material or product. It is part of a collection of sheets aimed at bringing together the available information to date that is likely to facilitate the reuse of building materials and products.

This sheet has been produced by Rotor vzw/asbl within the framework of the Interreg FCRBE project - Facilitating the Circulation of Reclaimed Building Elements, supported by the entire project partnership. Sources of information include the experience of reclamation dealers and involved project partners, lessons learned from exemplary projects, available technical documentation, etc.

The sheets have been produced between 2019 and 2021. As the reclamation sector is evolving, some information, notably regarding pricing and availability, may change over the time. When the text refers to European standards, it is up to the project team to refer, if necessary, to their national implementations and local specificities.

It is important to note that the information presented here is not exhaustive or intended to replace the expertise of professionals. Specific questions are always project related and should be treated as such.

The complete collection of sheets (including the introductory sheet) is freely available from different reference websites (a.o. [opalis.eu](http://opalis.eu), [nweurope.eu/fcrbe](http://nweurope.eu/fcrbe), [futureuse.co.uk](http://futureuse.co.uk)).

Non-exhaustive directories of dealers in reclaimed building materials are available on [www.opalis.eu](http://www.opalis.eu) and [www.salvoweb.com](http://www.salvoweb.com).

---

Interreg FCRBE partnership: Bellastock (FR), the Belgian Building Research Institute / BBRI (BE), Brussels Environment (BE), the Scientific and Technical Center of Building / CSTB (FR), Confederation of Construction (BE), Rotor (BE), Salvo (UK) and University of Brighton (UK).

The information contained in this document does not necessarily reflect the position of all the FCRBE project partners nor that of the funding authorities.

Unless explicitly stated otherwise, the content of these sheets is credited in the Creative Commons Attribution NonCommercial – Share Alike format (CCBY-NC-SA).



Unless explicitly stated, the images used in this document belong to © Rotor vzw/asbl or © Opalis. Any other image has been the subject of a systematic request for authorisation from their authors or rightful owners. When this request has not been answered, we assumed that there were no objections to the use of the image. If you feel that this interpretation is unreasonable, please let us know.





**Product description**

**Urinals are frequently found in sanitary facilities in public buildings (more rarely in homes). Compared to traditional toilet cubicles, they allow space saving and faster use, as well as some water saving. The most common models are enamelled sanitary ceramics, vitrified porcelain, stainless steel or synthetic materials.**

Urinals come in many shapes and models. This sheet focuses mainly on suspended urinals of relatively recent origin (from the middle of the 20th century). It does not explicitly address older types of urinals, such as older urinal stalls, also available in the antique materials market. The sheet also does not cover very recent models of urinals, such as urinals without water or with a cartridge system, which, to our knowledge, are still infrequent on the reclamation market.

We can categorise the types of urinals covered by this sheet according to their rinsing methods:

- **Vacuum-flush urinals.** The bowl is surrounded by a rim which ensures complete rinsing. A specific siphon ensures drainage. These models generally have a higher water consumption (0.5 l/s) and pipes with a larger diameter.
- **Flushing urinals.** The bowl is partially rinsed using a diffuser specific to each model. The drain is equipped with a classic siphon. The water consumption is generally lower (0.15 l/s) and the supply and discharge pipes are of a narrower diameter.

In addition to the toilet bowl, the proper functioning of a urinal also depends on all its accessories: the water supply (direct flow or with a tank), the supply device (visible, integrated or recessed, mechanical or automatic, synchronised or not with other urinals, etc.), the outlet grid or plug (independent or not of the bowl), the siphon (visible or built-in) or the supply and drainage piping. Depending on their condition, these parts can be reused (possibly after cleaning or repair). If necessary, they can be replaced.

Deposits of material and the visibly worn character of a urinal also have an influence on the appreciation by future users. Fortunately, cleaning procedures often make it possible to give this equipment a second life.

More broadly, urinals have great advantages when reused. The maintenance possibilities and the durability of ceramic elements explain their stable presence on the reclamation market. In addition, the installation of urinals is governed by national and European standards relating, among other things, to the dimensions of the water connection and drainage, water consumption and installation procedures. However, these have changed little over the past 20 years. Therefore, it can be assumed that urinal systems installed less than 20 years ago will broadly meet current requirements. Older equipment can also meet them. In all cases, it is necessary to ensure this and, if necessary, to provide for the necessary adaptations.

The evolution of uses could however impact the demand for this equipment in the near future since increasingly more public buildings are now opting for gender-neutral toilets.



*Suspended urinal with siphon-action, with rim, visible top feed and integrated waste.*



*Vacuum-flush suspended urinal without rim.*



*Suspended flushing urinal, diffuser and metal plug, visible supply and outlet. © [backacia.com](http://backacia.com)*



*Urinal stall*



*Collective installations can be supplemented with urinal separators, which are also suitable for reuse.*



## Product reclamation

**Generally easy to dismantle, urinals are good candidates for reclamation, either on site or through professional channels of product resellers.**

The potential for reuse depends mainly on the model, the quantities and the general condition of the lot. Sanitaryware coming from public facilities (school, offices, etc.) can prove to be interesting since they offer the possibility of constituting large batches of identical equipment.

→ **Potential assessment.** An "expert eye" generally makes it possible to estimate the potential for reclamation during an on-site visit or based on photos and technical information relating to the model, manufacturer, quantities, dimensions, etc. The focal points are among others:

- general condition: are the devices damaged (hairline fractures, fissures, cracks, scratches, etc.)? *A cracked device must not be reused.* Is the equipment clogged (limescale, mould)?
- condition of the accessories: does the rinsing device work? Is it cleanable or replaceable? What condition are the gaskets, siphon, etc. in?
- commercial interest, depending on the brand, model, quantity or even resale potential.
- logistical arrangements, in particular deadlines, handling and organisation of transport.

→ **Removal.** Careful disassembly should be aimed at ensuring the integrity of the fixture, equipment and accessories being considered for reclamation. If the fixture is still supplied with water, it is advisable to carry out a pre-cleaning. The water supply should then be shut off before disassembly. Some rinsing devices can be electrically powered (most often by cells or batteries, and sometimes directly through the mains). It is necessary to ensure that they are de-energized before dismantling.

The bowls are separated from the fixing supports and from the supply and drainage devices. There may be a sealant or a layer of sound insulation between the equipment and its support. Built-in flushing devices may prove more complicated when disassembling than exposed models.

If they are recovered, the functional accessories (rinsing and emptying device, support frames, etc.) must be correctly dismantled and listed. The lids can be held in place and secured with adhesive tape to prevent them from moving during transport. It is advisable to document the principle of fixing specific elements in order to facilitate their subsequent installation. Once dismantled, the urinals will be properly emptied, sorted by quality, colour and size and packaged in such a way as to avoid knocks and breakage.

Newer siphons (plastic or alloy) could theoretically be reclaimed after thorough cleaning. Alternatively, they can be replaced with compatible parts.

→ **Storage.** It is advisable to arrange the urinals so that their installation face rests on a flexible support, to avoid spillover from the pallets, and to provide dividers, strapping and possibly a wrapping film. Once cleaned and ready to be put back into operation, the elements should preferably be stored away from water and dust.

### Technical surveys

*If no technical documentation is available for the equipment, it may be useful to note certain indications before or during removal in order to facilitate re-installation: diameter of the supply and drainage pipes, flow rate and flush volume (sometimes noted on the equipment), reference numbers, etc.*



Potential assessment.



Removal of urinals



Storage of urinals



→ *Treatments, maintenance and cleaning.* Recent reclaimed urinals are generally sold without any treatment other than superficial cleaning with soapy water or even bleach (prohibited on stainless steel urinals). A descaler or vinegar is sometimes used to remove the most visible scale.

→ Some professionals offer deep cleaning and disinfection of ceramic equipment in order to remove tough deposits (limescale, mortar, paint, putty, etc.). After removing the metal and synthetic accessories, the devices are soaked in a specific acid solution before being pressure washed and then rinsed. Because of its additional cost, this process is especially interesting for mid-range and high-end urinals.

→ If superficial knocks affect the enamel layer, it is possible to carry out spot repairs using a specific product. These repairs will however remain visible. Ready-to-use kits are readily available on the market.

→ In all cases, it is advisable not to use abrasive products or metal objects to remove dirt, as this risks damaging the surface layer.

→ *Transport and delivery.* Necessary precautions must be taken during transport and delivery in order to limit knocks and scratches (dividers, corner protectors, strapping of pallets, etc.).

It is advisable to involve specialised professionals to ensure the smooth running of these operations.

**Checking the condition of the glaze**

*It is possible to test the condition of the glaze layer using an alcohol marker: if it is easily erased, the glaze is still in good condition, otherwise the glaze has probably become "porous".*



*"Porous" glaze vs glaze in good condition*



*Traces of scale on the rim, before cleaning*



*Dirty drainage device*



*Traces of scale on the rim, after cleaning*



*Partially cleaned drainage device*





### Applications and installation

**In principle, the re-use of reclaimed urinals does not differ in any way from that of new urinals. It must meet the same requirements of use, in particular - depending on the case - with regard to the properties and condition of the support (floor or wall), the installation height, the installation and grouting products and techniques, connections and plumbing, flushing volume, flushing trigger system, waterproofing, taps, wastewater disposal, accessibility for people with reduced mobility or children, the frequency of use, water consumption, specific maintenance measures, safety against vandalism, sound insulation, etc. In all cases, reference should be made to the European and national standards relating to the product (in particular EN 13407), to the rules of practice in force and to the installation standards.**

To facilitate the integration of reclaimed elements, the specifier takes care to formulate his expectations with regard to the following characteristics.

→ *Types and dimensions* of equipment. For example, flushing device (visible, integrated or recessed), with or without rim, etc. Leaving some latitude on the dimensions generally makes it easier to find a batch on the reclaimed market.

→ *Condition and degree of wear accepted*. It is important that urinals do not have any major cracks or breaks that could damage their seal. Depending on the case, however, it is possible to accept traces of surface wear, light traces of limescale or minor stains.

→ *Flushing volume*. Some contexts require specific performance in this regard. It will be necessary to verify that the flushing volumes of the urinals are reasonable and comply with the environmental standards in force. The current standard is to provide a maximum flushing volume of 5 litres of water per use. In fact, this quantity varies significantly from one system to another and some low-flow urinals allow only one litre of water to be used per flush. The rinsing volume must ensure good cleaning while preventing clogging of the sewer system (see specific standards). In some cases, it is possible to replace the flushing mechanism of older equipment which no longer meets these requirements. It is however a question of ensuring the feasibility and the appropriateness of such an op-

eration - in particular by taking into account the diameter and the slope of the downstream pipes. Where applicable, this involves precisely describing the expected operations in the specifications.

→ *Accessories*. Clearly specify in the specifications all the elements which, if applicable, must be provided by the company to replace or adapt existing toilet systems. Among the parts likely to be delivered as new, there are: support frame, control fittings, flushing mechanism, connection sleeve, air barrier or siphon, push button, seals, lid, etc. For each accessory, compatibility with the existing system must be ensured. This step is facilitated when the technical documentation is available. Certain accessories are sometimes available from professional reclamation dealers. For the most recent models, professional plumbing suppliers are usually able to offer compatible accessories.

Most of the reclaimed building products are sold as is. The conditions of sale may however contain specific guarantees specific to the product. Some suppliers are able to indicate the origin of the product and/or provide documentation on the purchased product (*for more information, see the Introduction Sheet*). When the equipment is recent enough, it is usually possible to find the manufacturer's technical documentation using the make and model number.

#### *Design tip!*

*To increase the chances of meeting the offer available on the reclamation market, the specifier can choose to accept several different lots and distribute them in an organised manner throughout the building. For example, provide a homogeneous batch per sanitary fixture block.*



*Crackling or crazing is the phenomenon responsible for the appearance of a set of hairline cracks in the glaze. These can lead to the penetration of liquids inside the fissure, causing the appearance of lasting stains and causing the development of pathogens. It is therefore advisable to discard equipment with this defect.*



Chiro Itterbeek (BE) © Rotor



**Characteristics and fitness for use**

A large number of harmonised European standards and national standards establish performance requirements relating to the various constituent parts of urinal systems (toilet bowl, flushing valves, emptying devices, support frame, etc.). Here we focus on **recent (~ 20 years) suspended urinals**, drawing on the characteristics established by the harmonised European standard EN 13407 (*Wall urinals in glazed sanitary ceramic or stainless steel*). Although itemised for new products, its content may prove useful in considering the reclamation of urinal systems.

Characteristics	Comments
<b>Dimensional characteristics</b>	In the case of recent equipment (~ 20 years), it can be assumed that, in most cases, the connection dimensions comply with standard EN 80 ( <i>Wall urinals - Connection dimensions</i> ).
<b>Flushing characteristic - Headroom</b>	<p>Urinals are generally defined according to their operating mode (siphon action or flushing, with or without a rim, with or without a specific siphon). Reference should be made to the original technical documents or to the technical information noted during removal in order to ensure the compatibility of all the components.</p> <p><i>Example 1:</i> depending on the model, flushing urinals generally require a flushing volume of between 0.5 and 5 L for a flow rate of <math>\leq 0.2</math> l/s. The inlet and outlet pipes can be smaller in diameter - but must take into account the risk of scaling. For increased efficiency and a similar flushing volume, siphon urinals require a flow rate of approximately 0.5 l/s and larger diameter pipes.</p> <p><i>Example 2:</i> the water seal is a hydraulic plug which remains in the siphon after rinsing in order to prevent the rise of odours from the pipes. The height of the water seal must not be less than 50 mm for siphon urinals and 75 mm for flushing urinals. If necessary, the siphon can be replaced.</p> <p>In all cases, wall-mounted urinals must operate with flushing and draining devices similar to those specified by the manufacturer. Most professional sanitaryware dealers are able to verify the suitability of equipment.</p>
<b>Flushing characteristic - Bowl flushing</b>	<p>Flushing should be effective on the interior walls of the urinal bowl. A visual inspection under installation conditions makes it possible to assess this performance (using fine sawdust for example). Note that flushing urinals generally flush over just a part of the surface (depending on the orientation and the level of fouling of the diffuser) while urinals with siphon action with rim must normally ensure the bowl is completely flushed (higher water consumption).</p> <p>Flushing must not cause any splashing to the outside of the bowl. It must allow the evacuation of residues (smaller in diameter than the drain holes) without overflowing out of the bowl. The good quality of the flushing can be ensured by testing with small plastic beads or coloured liquids in a working bowl.</p> <p>Furthermore, it can be assumed that if the flushing of the bowl of a reclaimed urinal was not satisfactory during its period of use, the bowl would show visible signs of wear. A visual inspection then makes it possible to judge this performance.</p>
<b>Water absorption</b>	<p>Reclaimed sanitary ceramic urinals must not absorb water. The presence of cracks, chips, sharp internal angles or signs of crazing in areas of the glaze that are in contact with water, negatively influence this performance.</p> <p>This characteristic can be assessed by visual inspection of the functional surfaces of the bowls, using an appropriate light source. Some imperfections can be repaired. Water absorption can also be determined by the test method described in EN 13407+A1 for glazed ceramic urinals.</p> <p>Experience shows that stainless steel urinals meet these requirements.</p>
<b>Chemical resistance</b>	The surface of urinals must be resistant to common chemicals and cleaning products. Experience shows that bowls made of sanitary ceramic and stainless steel meet this requirement. Note that bleach (and chlorine products in general) is not recommended for cleaning stainless steel equipment.



Characteristics	Comments
<b>Load resistance</b>	This characteristic determines the solidity of suspended urinals during use. This installation condition can be tested by fitting the urinal to a smooth vertical surface and applying a static load to it (for example: 100 kg load in the middle of the rim for 1 hour). The urinal should not crack, come loose from the wall or show any permanent deformation. Note that this performance is dependent on the properties of the support and the fasteners used.
<b>Reliability of the flushing device (tap)</b>	Particular specifications are applicable to the flush valve (inlet pressure, hydraulic characteristics, watertightness, inlet flow, materials, operating endurance, electrical and acoustic characteristics, etc.). These parameters can be difficult to check on reclaimed equipment.  The main consequences of a valve failure are wasted water (flush that flows or is triggered unexpectedly) and poor flushing efficiency (flow or volume too low). These failures can, depending on the case, be partially assessed on the equipment in operation (before removal, for example). If necessary, the taps can be replaced.
<b>Hazardous substances</b>	The equipment must be free from hazardous substances. To our knowledge, no hazardous material is likely to be present in reclaimed urinal equipment, except in the cells and batteries of automatic flushing devices.

**Availability**

Urinals are a very common product in the reclamation market. However, availability depends on the quantities required. As an example:

Frequent	Batch of 1 piece
Occasional	Batch of 2 to 20 identical pieces
Rare	Batch of > 20 identical pieces

**Indicative prices (Excl. tax)**

Random sampling of the reclamation market in Western Europe (Belgium, France, Great Britain and the Netherlands) made it possible to extract some indicative prices. These vary depending on the models, materials and original manufacturer. Some prices:

- Supply: 15 to 150 € /item
- Urinal separator: 40 to 150 € /item
- Removal cost: around 35 to 50 € /item
- Specific cleaning service: 10 to 20 € /item

However, the replacement of missing or defective parts should also be budgeted for.

Even taking into account these operations specific to reclamation logic, urinal equipment is generally competitive with new products, in particular for mid-range and high-end models.

**Find specialised businesses**



[salvoweb.com](http://salvoweb.com)

[opalis.eu](http://opalis.eu)

**Embodied carbon (Cradle to gate - production A1-A3)**

	kg CO <sub>2</sub> eq./PU
INIES database (FR) – Generic data *	50,1
Geberit - Individual declaration **	42,6

\*Indicative value for PU (Product Unit) = standard range ceramic urinal (vitreous porcelain) with a reference lifespan of 20 years. Push button, drain, siphon and gaskets included.

\*\* Indicative value for PU (Product Unit) = standard range ceramic urinal (vitreous porcelain) with a reference lifespan of 20- 25 years. Push button, drain, siphon and seals excluded.

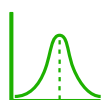

According to the sources, reusing a standard range suspended urinal prevents the equivalent production of ~ 42,6 to ~ 50,1 kg of CO<sub>2</sub> related to the manufacture of new equipment (production phase only). By way of comparison, this corresponds to the emissions caused by a small diesel car during a trip of ~ 250 to ~ 300 km.



**Disclaimer**

This sheet is intended for designers, specifiers and other members of construction project teams wishing to reuse this building material or product. It is part of a collection of sheets aimed at bringing together the available information to date that is likely to facilitate the reuse of building materials and products.

This sheet has been produced by Rotor vzw/asbl within the framework of the Interreg FCRBE project - Facilitating the Circulation of Reclaimed Building Elements, supported by the entire project partnership. Sources of information include the experience of reclamation dealers and involved project partners, lessons learned from exemplary projects, available technical documentation, etc.

The sheets have been produced between 2019 and 2021. As the reclamation sector is evolving, some information, notably regarding pricing and availability, may change over the time. When the text refers to European standards, it is up to the project team to refer, if necessary, to their national implementations and local specificities.

It is important to note that the information presented here is not exhaustive or intended to replace the expertise of professionals. Specific questions are always project related and should be treated as such.

The complete collection of sheets (including the introductory sheet) is freely available from different reference websites (a.o. [opalis.eu](http://opalis.eu), [nweurope.eu/fcrbe](http://nweurope.eu/fcrbe), [futureuse.co.uk](http://futureuse.co.uk)).

Non-exhaustive directories of dealers in reclaimed building materials are available on [www.opalis.eu](http://www.opalis.eu) and [www.salvoweb.com](http://www.salvoweb.com).

---

Interreg FCRBE partnership: Bellastock (FR), the Belgian Building Research Institute / BBRI (BE), Brussels Environment (BE), the Scientific and Technical Center of Building / CSTB (FR), Confederation of Construction (BE), Rotor (BE), Salvo (UK) and University of Brighton (UK).

The information contained in this document does not necessarily reflect the position of all the FCRBE project partners nor that of the funding authorities.

Unless explicitly stated otherwise, the content of these sheets is credited in the Creative Commons Attribution NonCommercial – Share Alike format (CCBY-NC-SA).



Unless explicitly stated, the images used in this document belong to © Rotor vzw/asbl or © Opalis. Any other image has been the subject of a systematic request for authorisation from their authors or rightful owners. When this request has not been answered, we assumed that there were no objections to the use of the image. If you feel that this interpretation is unreasonable, please let us know.



**Product description**

**The use of basins for personal care and hygiene has been demonstrated in many cultures over time. However, it is the progressive development of running water and sewerage infrastructures in major cities during the 19<sup>th</sup> century which marked the emergence of modern washbasins. Closely connected to these networks, they now occupy a fixed place in buildings.**

In the late 19<sup>th</sup> century to the early 20<sup>th</sup> century, washbasins are readily covered with a wide variety of patterns. Many manufacturers then offered to customise standard models by offering a wide range of decorative patterns. This taste for ornamentation gradually gave way to models with more refined lines and appearance in the first half of the 20<sup>th</sup> century.

Today we continue to find a very wide variety of washbasins, characterized by:

- Their *material*: sanitary ceramics (vitrified porcelain or glazed stoneware), sheet steel, enamelled cast iron, stainless steel or even synthetic materials (acrylic, resins, etc.).
- Their *fastening system*: suspended, on a column, placed or built into a piece of furniture or a worktop.
- Their *uses*: domestic or community, one or more tanks.
- Their *shapes, appearance* and *colours*.
- Their *connections* to the plumbing: presence or absence of an overflow, presence or absence of one or more holes for the taps, dimensions of the drain, manual (plug) or mechanical (pop-up) closure, etc.

This sheet focuses on recent washbasins from domestic and public buildings. Far from being the only models available on the reclamation market (think of antique washbasins, for example), they are still quite common there. Their relative ease of maintenance and durability make them good candidates for reuse. Added to this is the fact that European standards for sanitary fittings have changed little over the past 20 years, making it easier to integrate them into new installations.

By extension, the general principles described in this sheet can also be applied to the reclamation of hand washbasins (small washbasins often intended for WCs), slop sinks (intended for collecting waste or cleaning water) and bidets (intended for washing the genitals while sitting). This sheet does not cover the taps which, depending on the case, can be kept as is, restored or replaced. In general, plumbing components age badly, which is why reclaimed sanitary fixtures are often installed with new plumbing and fittings.



*Suspended washbasin: fixed by dowels, suspension brackets or side mounts*



*Double bowl domestic washbasin*



*Community stainless steel washbasin*



*Slop sinks*



*Washbasin on column : resting on a profiled central support*



*installed or built-in : in a vanity unit or on a counter-top (built-in from above or below)*



## Product reclamation

Generally easy to dismantle, washbasins can be reclaimed on site or recovered by professional resellers. The interest of resellers in these items will strongly depend on the model, the quantities and the general condition of the lot in question. Large batches of identical parts, such as can be found in public facilities (schools, offices, etc.), are generally appreciated. That said, smaller batches of characteristic pieces can also spark the interest of professionals.

→ *Evaluation of potential.* An "expert eye" generally makes it possible to estimate the potential for keeping and reclaiming during an on-site visit or based on photos and technical information relating to the manufacturer, the model, the dimensions. The focal points will be among others:

- general condition: are the devices damaged (cracks, fissures)? Is the seal compromised? Is the equipment clogged (limescale, mould)? Is the coating layer in good condition?
- the condition of the accessories (drain, column, fixing brackets, seals, etc.) and, if necessary, the possibilities of replacement.
- Commercial interest depending on model, quantity, the potential for keeping or re-sale, ease of cleaning and maintenance.
- logistics arrangements (deadline, working time, handling, transport, etc.).

→ *Removal.* Careful dismantling should aim to ensure the integrity of the installation, the equipment and its accessories. The water supply should be cut off beforehand. Functional accessories and specific mounting brackets must be properly listed. It is advisable to document the fixing principle in order to facilitate refitting. The washbasins will be sorted by qualities, colours and dimensions. They are packaged in such a way as to avoid bumps and breakage. For example: storage on the side and on a flexible support, avoid support points on non-dismantled taps and use interlayer protections.



Removal of washbasins for reclamation

→ *Storage.* The items are best stored away from water and dust.

→ *Treatments/maintenance/cleaning.* in general, used washbasins are sold without any treatment other than surface cleaning with a weak acid (for example: vinegar) for traces of limescale and classic degreasing products. Any traces of putty and mortar are removed. It is advisable not to use abrasive products or metal objects to remove dirt, as this may damage the surface layer.

Some professionals offer deep cleaning and disinfection of ceramic equipment, in order to remove tough deposits (such as limescale, mortar, paint, putty). After removing the metal accessories, the devices are soaked in an acid solution before being pressure washed and rinsed.

If superficial blows affect the glaze layer, it is possible to carry out spot repairs. Ready-to-use kits are readily available on the market.

→ *Transport and delivery.* the necessary precautions must be taken during transport and delivery in order to limit knocks and scratches (interlayer protection, corner protectors, strapping of pallets, etc.).

It is advisable to involve specialised professionals to ensure the smooth running of these operations.



Reclamation supplier showroom



Slop sink before and after thorough cleaning



Removal of adhesive remains

### Checking the condition of the glaze

It is possible to test the condition of the glaze layer using an alcohol marker: if it is easily erased, the glaze is still in good condition, otherwise the glaze has probably become "porous".



"Porous" glaze vs glaze in good condition





### Applications and installation

**The reuse of reclaimed washbasins is no different from that of new washbasins. It raises the same points for attention, in particular: properties and condition of the wall support, installation height, adaptability to people with reduced mobility (PRM), installation and grouting products and techniques, connections and plumbing, gaskets, valves, installation deadlines, costs, specific maintenance, etc.**

In all cases, reference should be made to the European and national standards relating to the product (EN 14296 and EN 14688) and to the rules of practice in force (or implementation standards). To facilitate installation, the designer/specifier will take care to use washbasins having the following characteristics.

→ *Types and dimensions.* It must correspond to the expressed needs. Leaving some latitude on the dimensions generally makes it easier to find a batch on the reclamation market.

→ *Condition.* Reclaimed washbasins must not have any major cracks or breaks likely to damage the watertightness of the bowl. Slight alterations such as signs of surface wear, traces of scale or stains, however, do not affect the watertightness of the bowl.

→ *Accessories.* in the event of worn or defective parts, it is necessary to ensure the compatibility of the reclaimed washbasins with the taps and spare parts (new or used), namely: plug, mechanical trap, pop-up mechanism, specific fixing means, connections, shut-off valves and rosettes, external overflows, drain and strainer or even drain fittings with siphon. Having the technical documentation of the original part can facilitate this work. Most professional sanitary ware dealers are able to offer compatible accessories.

Caution is advisable in the event of change of installation method. For example, most wall-mounted washbasins have not been glazed on the back side and are therefore not suitable for use as a top-mounted washbasin.

Most of the reclaimed building products are sold as is. The conditions of sale may however contain special guarantees specific to the material. Some suppliers are able to indicate the origin of the product and/or provide documentation on the product purchased (for more information, see the introductory sheet). For recent equipment, it is generally possible to find the original technical documentation using the make and model.



#### Design tip!

*Changes to the tap system are possible but must be precisely described to the operators. For example, it is feasible to switch from a system with separate inlet to a mixing valve system. It is then necessary to provide hole covers to block the unused fixing locations.*



Washbasins reuse. Private project (BE)  
© Sophie Boone



Washbasins reuse. Chiro Itterbeek (BE) © Rotor



Reuse of slop sinks, Bar Mono Le Terrain Vague, Paris (FR) © FAIRE AVEC architecture



**Characteristics an fitness for use**

The harmonised European standard EN 14688 EN 14296 establishes the relevant characteristics (depending on the context) in order to determine the fitness for use of washbasins for domestic and community use. Although detailed for new products, these characteristics may prove useful in considering the specific case of reclaimed washbasins.

Characteristics	Comments
<b>Load resistance</b>	This characteristic determines the solidity of suspended or column equipment during use “according to the manufacturer’s instructions”. In the case of reclaimed washbasins, it is possible to test this performance under installation conditions (in the absence of instructions from the supplier, refer to the expertise of a plumber!) by applying a static load (for example: 2 bags of 50 kg placed on top of the standard-sized washbasins for 1 hour). The washbasins must not crack, collapse or exhibit a permanent deformation that would prevent the drainage of water. For bidets, a load resistance of 400 kg (~ 4 kN) for 1 hour should be considered.
<b>Water drainage</b>	The bottom of the bowl of the equipment must have a shape suitable for draining water without stagnation when the plughole is open. This can be checked by pouring water into the basin of the sinks in use. This feature could also be applicable to the rim of the washbasin (for example at the level of the integrated soap dishes).
<b>Resistance to temperature variations</b>	Sanitary appliances must withstand thermal shock (change in water temperature). Experience has shown that washbasins made of sanitary ceramic, stainless steel, enamelled steel and glass meet this requirement.
<b>Chemical resistance</b>	The surface of sanitary equipment must be resistant to common chemicals and cleaning products. Experience has shown that washbasins made of sanitary ceramic, stainless steel, enamelled steel and glass meet this requirement. Note that the use of bleach (and chlorinated products in general) is particularly not recommended for stainless steel equipment.
<b>Abrasion and scratch resistance</b>	This characteristic is mainly applicable to equipment made from synthetic materials (e.g. acrylic). In the case of reclamation, we can estimate that equipment which has already been used AND which does not have any abrasion/scratch (AND which one plans to re-use under similar conditions of use) has in a way shown its ability to withstand these stresses. This deduction can be assessed following a visual or detailed examination.
<b>Suitability for cleaning</b>	This characteristic is mainly related to the surface appearance, to the shape and to the properties of the material constituting the equipment. In general, shapes with sharp edges are less easy to clean. Likewise, porous materials (certain stones, cement) are more prone to deposits. Finally, wear defects such as chips in the glaze can also complicate cleaning. Careful visual inspection of surfaces can already give a valuable indication of cleanability. If necessary, some small imperfections can be repaired.
<b>Overflow protection</b>	The presence of an overflow must allow water to drain, without overflowing, when the main drain is closed. The capacity of the overflow therefore depends on the inlet rate. This capacity can be checked when in use. In the absence of an overflow, it is recommended to ensure that the discharge device remains open at all times.

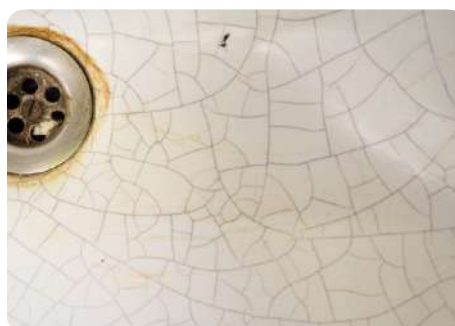

*Crackling or crazing is the phenomenon responsible for the appearance of a set of hairline cracks in the glaze. These can lead to the penetration of liquids inside the fissure, causing the appearance of lasting stains and causing the development of pathogens. It is therefore advisable to discard equipment with this defect.*



**Embodied carbon (Cradle to gate - production A1-A3)**

	kg CO <sub>2</sub> eq./PU	kg CO <sub>2</sub> eq./kg
INIES database (FR) – Generic data- glazed ceramic *	104,0	-
INIES database (FR) - AFISB collective data - white porcelain **	62,0	2,1
INIES database (FR) – Generic data- enamelled steel ***	68,8	-
INIES database (FR) – Generic data- synthetic material ****	54,6	-

\* Indicative value for PU (Product Unit) = Standard range washbasin in glazed ceramic for a reference life of 20 years. Taps and drainage products are not included.

\*\* Indicative value for PU (Product Unit) = Standard range pedestal washbasin 50 to 70 cm wide, in porcelain (~ 30 kg) for a reference lifespan of 20 years. The taps are not included.

\*\*\* Indicative value for PU (Product Unit) = Built-in enamelled steel washbasin for a reference lifespan of 20 years. The taps are not included.

\*\*\*\* Indicative value for PU (Product Unit) = Built-in acrylic washbasin (8 kg) for a reference life of 20 years. The taps are not included.

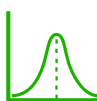

According to the sources, reusing a standard range washbasin prevents the equivalent production of ~ 55 to ~ 104 kg of CO<sub>2</sub> related to the manufacture of new washbasins (production phase only). This corresponds to a journey of ~ 328 to ~ 624 km in a small diesel car.

**Availability**

Ceramic washbasins are a very common product in the reclamation market. However, availability depends on the quantities required. As an example:

Frequent	Batch of 1 piece
Occasional	Batch of 2 to 10 identical pieces
Rare	Batch of > 10 identical pieces

To increase the chances of meeting the offer available on the reclamation market, the designer/specifier can choose to split large surfaces into smaller quantity batches (for example, by providing different models in each room).

**Indicative prices (Excl. tax)**

Random sampling of the reclamation market in Western Europe (Belgium, France, Great Britain and the Netherlands) made it possible to extract some indicative prices. These vary depending on the models, materials and original manufacturer. Designer washbasins, pedestal washbasins with clean lines from the 1950s, colourful hand basins from the 1970s are very popular.

Some prices:

- Cost of supplies: 20 to 200 €/item for standard range models
- Removal cost: around 40-50 €/item
- Cleaning service: 10-20 €/item

At these prices, it is sometimes advisable to provide for a supplement for the replacement of the seals, the taps or certain accessories as well as for cleaning or descaling.



Illustrated manual for removing washbasins and taps: <https://reuse.brussels/nl/lavabos-et-robinetterie/> (In French)

**Find specialised businesses**



[salvoweb.com](http://salvoweb.com)

[opalis.eu](http://opalis.eu)



**Disclaimer**

This sheet is intended for designers, specifiers and other members of construction project teams wishing to reuse this building material or product. It is part of a collection of sheets aimed at bringing together the available information to date that is likely to facilitate the reuse of building materials and products.

This sheet has been produced by Rotor vzw/asbl within the framework of the Interreg FCRBE project - Facilitating the Circulation of Reclaimed Building Elements, supported by the entire project partnership. Sources of information include the experience of reclamation dealers and involved project partners, lessons learned from exemplary projects, available technical documentation, etc.

The sheets have been produced between 2019 and 2021. As the reclamation sector is evolving, some information, notably regarding pricing and availability, may change over the time. When the text refers to European standards, it is up to the project team to refer, if necessary, to their national implementations and local specificities.

It is important to note that the information presented here is not exhaustive or intended to replace the expertise of professionals. Specific questions are always project related and should be treated as such.

The complete collection of sheets (including the introductory sheet) is freely available from different reference websites (a.o. [opalis.eu](http://opalis.eu), [nweurope.eu/fcrbe](http://nweurope.eu/fcrbe), [futureuse.co.uk](http://futureuse.co.uk)).

Non-exhaustive directories of dealers in reclaimed building materials are available on [www.opalis.eu](http://www.opalis.eu) and [www.salvoweb.com](http://www.salvoweb.com).

---

Interreg FCRBE partnership: Bellastock (FR), the Belgian Building Research Institute / BBRI (BE), Brussels Environment (BE), the Scientific and Technical Center of Building / CSTB (FR), Confederation of Construction (BE), Rotor (BE), Salvo (UK) and University of Brighton (UK).

The information contained in this document does not necessarily reflect the position of all the FCRBE project partners nor that of the funding authorities.

Unless explicitly stated otherwise, the content of these sheets is credited in the Creative Commons Attribution NonCommercial – Share Alike format (CCBY-NC-SA).



Unless explicitly stated, the images used in this document belong to © Rotor vzw/asbl or © Opalis. Any other image has been the subject of a systematic request for authorisation from their authors or rightful owners. When this request has not been answered, we assumed that there were no objections to the use of the image. If you feel that this interpretation is unreasonable, please let us know.



**Product description**

Cast iron radiators appeared on the market in the second half of the 19th century. Between 1910 and 1970 cast iron hot water central heating radiators were produced on a large scale, before pressed steel radiators started to take over in the 1960s. Cast iron radiators are still frequently found in private homes, schools, hospitals or administrative buildings of these periods. Column radiators, panel radiators or hospital radiators are among the most common types available on the market. Each type comes with a large variety of styles and dimensions.

As a general principle, hot water circulates in the columns and gives out heat by radiation and convection (in a proportion that depends on their type, finish and colour). The sections vary in size depending on the model. The individual elements are connected by threaded connectors which are best dismantled for thorough cleaning and restoration. Heat output is modified by adjusting the number of sections. This requires skills, experience, tools and pressure testing equipment.

Cast iron radiators adapt well to new heat production systems (low temperature boiler, heat pump, etc.). Although heavy and fragile, they have been enjoying a resurgence in popularity since the 1970s, especially for the pleasant heat they give off and their energy savings. Their cost is relatively high. Warranties are offered by some dealers.

→ **Types:** there are a fairly wide variety of types, from 1 to 9 columns, flowery, smooth, screen, round, corner models, plate warmers, etc. The dimensional characteristics of the individual elements are in the order of H [34 to 105] cm × W [7–22] cm × D [5–6.5] cm. The individual elements weigh from 3 to 13 kg and give a heat output of 35 to 240 W depending on the type of boiler, operating temperature water, room temperature, outside air temperature, the colour and finish of the radiator.

→ **Colours:** it is common to find refurbished cast iron radiators that are coated with an anti-rust primer (raw finish, matte anthracite grey). The type and colour of the paint influence the proportion between radiant and convected heat. Matt finishes black or dark colours give the most radiant heat output,

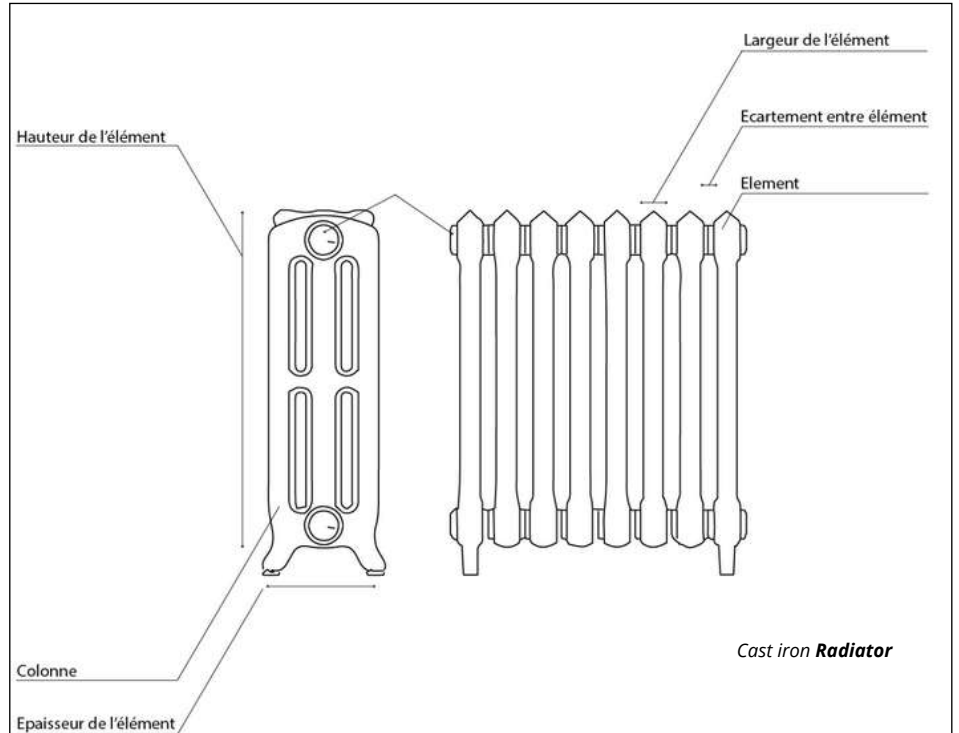

Graphic representation of a cast iron radiator © ROTOR et SIXIEME CONTINENT

while light-coloured and metallic finishes give out the least radiant heat (rendering a radiator into a convected air heater). The use of low VOC eco-friendly paints should be preferred over polyurethane paints, to avoid contaminating old radiators.

→ **Accessories:** specialist dealers are generally able to supply new valves, reducers and adaptors for modern plumbing sizes, cast iron feet for footless radiators and wall mounting brackets.

*Did you know?*

*It is now possible to electrify old cast iron radiators by adding an insulated electrical resistance.*



Column radiators - 'Classic' style



Column radiators - 'Flowery' style



Panel radiators



**Product reclamation**

Cast iron radiators are readily found; their recovery is relatively easy, and represents a great opportunity for reuse. Specialised operators can assist you with a complete overhaul and upgrading of radiators in the event of reuse on site. These same operators are also likely to buy and/or sell batches of reclaimed cast iron radiators while ensuring the smooth running of the following operations:

→ *Dismantling test* (or expert opinion): in practice, it makes it possible to ensure the feasibility and profitability of a removal. An 'expert eye' generally makes it possible to estimate the interest of a batch based on photos or existing technical information (manufacturer, model, dimensions, power, etc.), or through an on-site visit. The focal points will be among others:

- *general condition of the batch: are the appliances badly damaged? Rust spots or water under the radiator can indicate a leak or betray a radiator that has frozen.;*
- *commercial interest (depending on model, quantity, possible repairs, resale potential, etc.);*
- *logistics arrangements (deadline, working time, difficulty in handling, transport, etc.).*

→ *Reclamation*: careful dismantling should aim to ensure the integrity of the appliance and its accessories. After having drained the installation, it is recommended to first remove the valve and the mounting brackets. The radiators will be sorted by models, qualities and dimensions. The specific mounting brackets will be retained. The heavy weight of some cast iron radiators will require special lifting arrangements. Most of the specialised operators do not carry out the removal themselves and only carry out a ground floor collection/delivery, to the front door.

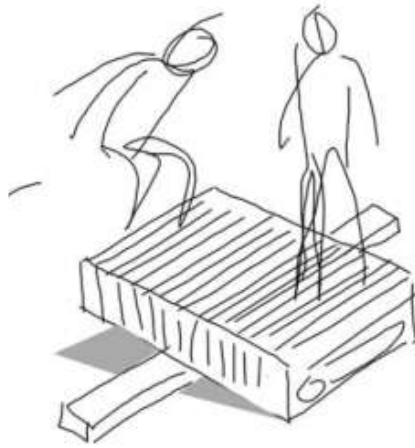

© ROTOR et SIXIEME CONTINENT

→ *Storage*: Since cast iron is less prone to corrosion than steel, and radiators will undergo a complete overhaul, they will usually be drained of their water, stored horizontally and temporarily stacked outside. However, prolonged storage outdoors can complicate the subsequent dismantling of the elements and heavy stacking can cause microcracks due to the heavy weight of the radiators. After overhaul, cast iron radiators will be stored vertically, without stacking, protected from frost and bad weather.



© LIONEL BILLIET

*Although it is technically possible to recompose cast iron radiators from individual sections, it is not advisable to break them into several fragments when removing them. Although this method is sometimes recommended to limit handling loads, it is always preferable to refer to the advice of the professional who will take care of their restoration.*

*If necessary, a precise cut can be considered to separate the elements.*

*The presence of lead paint on old cast iron radiators is common. In this case, a thorough overhaul of the radiators and their stripping is highly recommended.*



Selective removal



Storage before revision



Storage after revision (preferably vertically)





→ **Treatments:** Specialist operators usually subject used cast iron radiators to a thorough overhaul. Several methods for this exist. Most of the time, radiators will undergo the following treatments:

- chemical stripping to remove the old paint (sometimes toxic!);
- sludge removal to eliminate the sludge present inside the columns and guarantee optimum thermal performance;
- high pressure cleaning;
- sodablasting/sandblasting suitable for removing rust residues without drilling the elements;
- (resizing if necessary – by adding or removing elements – to meet the need for thermal power);
- (replacement of nipple seals if necessary);
- (tapping and replacement of outlet plugs if necessary);
- anti-rust primer;
- polyurethane finish paint according to RAL colour chart (powder coating is not advised);
- leakage check by pressurising from 4 to 8 bars.

→ **Transport and delivery:** cast iron is very fragile and is not that resistant to knocks. The necessary precautions must therefore be taken during transport and delivery in order to limit knocks and scratches (interlayer protection, corner protectors, transport in vertical position, strapping of pallets, etc.). The heavy weight of some radiators should be taken into account. Painted radiators sometimes come with a touch-up pen.

It is advisable to involve specialised professionals to ensure the smooth running of these operations.



Chemical pickling



Replacement of outlet plugs © LIONEL BILLIET



Pressurisation test © DECAPFONTE



High-pressure cleaning



Painting



Delivery of the revised radiators. © LIONEL BILLIET



### Applications and installation

**As a general rule, the choice of heating appliances must take into account the expected stresses (see § 'characteristics and fitness for use') and factors such as aesthetics, thermal comfort, etc. In all cases, reference should be made to the European and national standards relating to the product (EN 442-1) and to the rules of practice in force (or implementation standards).**

The design of a heating system based on reclaimed cast iron radiators differs little from a design using new elements. Thanks to their modularity, it is possible to completely reconfigure most of the classic radiators. Resizing rare models is very difficult, if not impossible. It is also possible to order a 'bespoke' reclaimed cast iron radiator. Most specialist dealers can assist you in the design and choice of radiators.

→ **Power required:** this data determines the heat requirement of the rooms to be heated. This is determined by the climatic zone in which the building is located, the type and volume of the rooms, the general insulation of the building, the operating mode of the heat production, etc.

→ **Nominal power of a radiator:** this parameter determines the capacity of a radiator to emit heat. It is determined by the type of radiator (model, dimensions, number of elements) and by the operating mode of the heat production. This information is available from dealers for the most common models. In the event that the manufacturer is not known or that the calculation conditions are modified (for example in the case of an operating mode at low temperature), it is possible to obtain this information from charts available on the Internet (I.e. <http://radiateur-fonte.com>, <https://www.radiastyl.fr>).

→ **Sizing of the radiators:** this calculation takes into account the required power, the nominal power of the radiators and their size, the available space, etc.

The reuse of reclaimed cast iron radiators is no different from that of new radiators. They lend themselves to the same variety of installation methods (wall mounting bracket, support feet). They raise the same points for consideration, in particular: thermal power, connection possibilities, sealing of the radiator and connections, conformity and compatibility of accessories (thermostatic valves, bleed screws, plugs), aesthetics, safety (rounded corners), heat reflecting surface behind the radiator, weight of radiators, etc. To facilitate installation, the designer/specifier will ensure that radiators meeting the following characteristics are used.

→ **Types and dimensions:** they must correspond to the needs expressed by the designer/specifier in order to obtain the desired thermal power.

→ **Condition:** reclaimed cast iron radiators that have undergone an overhaul must be airtight, free from rust and compatible with the desired connection system.

→ **Quantity:** to increase the chances of meeting the offer available on the reclaimed market, the designer/specifier can choose to split the batch with different models.

→ **Accessories:** outlet plugs, nipple washers, valves, taps, bleed screws and fixing systems can be replaced and brought up to standard. Most of these accessories are available in new (contemporary or reissue) or reclaimed versions from professional resellers.

Most of the reclaimed building product are sold as is. In the particular case of cast iron radiators, a **warranty up to 20 years** may accompany, depending on the service provider. Some suppliers are also able to indicate the origin of the product and/or provide documentation on the product purchased (for more information, see the **introduction sheet**).



Caserne de Reuilly, Paris Habitat - In situ reuse of 85 cast iron radiators. © ROTOR and SIXIEME CONTINENT



New valves - old style reissue



Dealer's showroom



**Characteristics and fitness for use**

The harmonised European standard EN 442 establishes the relevant characteristics (depending on the context) to be observed in order to determine the fitness for use of radiators and convectors. Although detailed for new products produced from 2002 onwards, these characteristics may prove useful in considering the specific case of reclaimed cast iron radiators.

Characteristics	Comments
<b>Reaction to fire</b>	The reaction to fire of a cast iron radiator depends primarily on the thickness of the surface coating. The thickness of the paint layer applied by spray gun by professional dealers is less than 1 mm (surface density < 1 kg/m <sup>2</sup> ); reclaimed cast iron radiators can therefore be considered to be non-combustible materials and belong to the European reaction to fire class A1 without prior testing.
<b>Release of hazardous substances</b>	The presence of lead paint on old cast iron radiators is common. In this case, a thorough overhaul of the radiators and their stripping is highly recommended. The paints used for reconditioning radiators must comply with the standards in force (in particular VOC).
<b>Sealing and pressure resistance</b>	The radiator must be able to withstand a pressure 1.69 times the maximum operating pressure. Reclaimed cast iron radiators are generally sold after passing a seal test (4 to 8 bar). A 5 to 20 year waterproof warranty is generally offered by resellers.
<b>Surface temperature</b>	/
<b>Thermal power and characteristic curve</b>	<p>The exact thermal output of a used cast iron radiator cannot be calculated according to the tests described in standard EN 442-2. It is determined by the type of radiator (model, dimensions, number of elements) and by the operating mode of the heat production. This information is available from dealers for the most common models. In the event that the manufacturer is not known or that the calculation conditions are modified (for example in the case of an operating mode at low temperature), it is possible to obtain this information from charts available on the Internet.</p> <p>The presence of corrosion sludge or lime deposits inside radiators is frequent and can be responsible for a decrease in thermal performance. It is therefore recommended to remove sludge from the radiators before re-installation. This operation is carried out by specialised operators.</p>
<b>Corrosion resistance</b>	For new products, this characteristic is tested by verifying the absence of surface corrosion after 100 hours of exposure to humidity. This characteristic is therefore closely linked to the correct application of an anti-rust primer to stripped radiators.
<b>Resistance to small impacts</b>	This characteristic concerns the coating layer. Correct application of two-component polyurethane spray paints is recommended. Powder coating is prohibited because it would damage the nipple seals.
<b>Superficial defects</b>	The radiator must be free from burrs that could cause injury. Specialised operators check and correct these faults.

It is advisable to carefully examine the conditions under which cast iron radiators are serviced (this information can be requested from specialist operators).





**Availability**

Cast iron radiators are a very common product in the reclamation market. However, availability depends on the quantities required. As an indication, for classic cast iron radiators (1920-1970), we can find batches of compatible radiators (identical modular system) in the following quantities:

Frequent	Batch of 1 to 10 pieces
Occasional	Batch of 11 to 20 pieces
Rare	Batch of > 20 pieces

Older, highly decorated radiators are often rare items. Note that at some specialist dealers, radiators are only renovated once sold.

**Embodied carbon or Global Warming Potential**

It is relatively difficult to estimate the ecological impact of reusing cast iron radiators since there is to our knowledge no data on this subject. However, the following elements can provide food for thought:

→ In view of their success, cast iron radiators on the reclamation market in Europe are likely to have travelled great distances. Reclamation suppliers source from large areas and some popular models sometimes come from the United States.

→ The impact of radiator renovation operations is not negligible and must be taken into account (painting, stripping, etc.).

→ The replacement of cast iron radiators with new, lighter sheet steel radiators is subject to debate. Cast iron radiators have a slow rise in temperature and good thermal inertia, unlike common sheet metal radiators. In general, the energy consumption of radiators is highly dependent on the overall insulation of the building and the desired thermal comfort.

→ The impact of the production of new or recycled cast iron is not negligible.

**Indicative prices (excl. tax)**

A non-exhaustive sample of the Western European reclaim market (Belgium, France, UK, and the Netherlands) has allowed us to extract some indicative prices.

The prices observed vary greatly depending on the models, dimensions, total radiator power, finish and suppliers. Prices are generally given per modular element. To find out the indicative price of a radiator, simply multiply by the number of elements that make it up.

*Supply price* (painting included, excluding antiques):

→ Flowery/smooth models: €70-110/element

→ Classic models: €15-35/element

→ Curtain models: €20-25/element

*Renovation price* (painting included):

→ Flowery/smooth models: €20-45/element

→ Classic models: €10-30/element

*Valves* (new, reissue): €60-150/kit

*Fixing brackets* (feet or wall): €10-15/piece

**Tip!**

*To increase the chances of meeting the supply available on the reuse market, the designer/specifier may choose to split the large areas into smaller batches (e.g. with different models in each room).*

**Hazardous substances and precautions**

*Lead:* a lead diagnostic may be necessary or mandatory (i.e. in France) to detect the presence of old lead paints on cast iron radiators. In this case, it is strongly recommended to strip and/or repaint the radiators through a specialised dealer.

**Find specialised businesses**



[salvoweb.com](http://salvoweb.com)

[opalis.eu](http://opalis.eu)

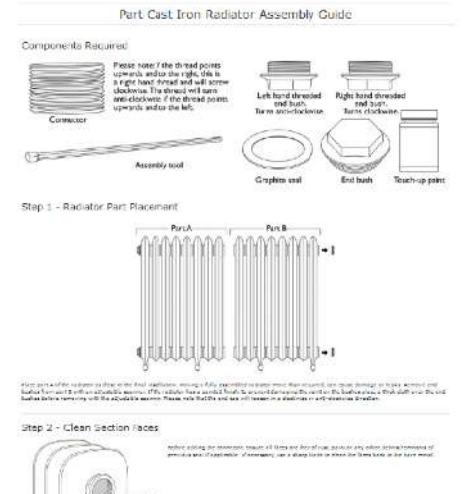

An illustrated manual for assembling a cast iron radiator <https://www.carron.uk.net/radiators/part-radiator-assembly-guide/>

Nombre de colonnes	Hauteur avec pied cm	Hauteur sans pied cm	Épaisseur élément cm	Longueur élément cm	Poids élément kg	Puissance watt ▲ 150°C
2	41,5	36,5	6,8	5,5	2	37
	61,5	56,5			2,9	49
	76,5	71,5			3,2	57
	91,5	86,5			3,9	69
	105,5	100,5			4,8	81
4	35	29,5	14,6	6	2,9	44
	45	40			4	62
	65	60			5,4	88
	80	75			6,4	110
	95	90			7,8	128
6	107	102	22.3	6	9	145
	35	29,5			4,1	64
	45	40			5,6	91
	65	60			7,8	127
	80	75			9,5	159
	95	90			11,5	191
	107	102			14,7	220

Example of a power table: <http://radiateurfonte.com>, <https://www.radiastyl.fr>

**Disclaimer**

This sheet is intended for designers, specifiers and other members of construction project teams wishing to reuse this building material or product. It is part of a collection of sheets aimed at bringing together the available information to date that is likely to facilitate the reuse of building materials and products.

This sheet has been produced by Rotor vzw/asbl within the framework of the Interreg FCRBE project - Facilitating the Circulation of Reclaimed Building Elements, supported by the entire project partnership. Sources of information include the experience of reclamation dealers and involved project partners, lessons learned from exemplary projects, available technical documentation, etc.

The sheets have been produced between 2019 and 2021. As the reclamation sector is evolving, some information, notably regarding pricing and availability, may change over the time. When the text refers to European standards, it is up to the project team to refer, if necessary, to their national implementations and local specificities.

It is important to note that the information presented here is not exhaustive or intended to replace the expertise of professionals. Specific questions are always project related and should be treated as such.

The complete collection of sheets (including the introductory sheet) is freely available from different reference websites (a.o. [opalis.eu](http://opalis.eu), [nweurope.eu/fcrbe](http://nweurope.eu/fcrbe), [futureuse.co.uk](http://futureuse.co.uk)).

Non-exhaustive directories of dealers in reclaimed building materials are available on [www.opalis.eu](http://www.opalis.eu) and [www.salvoweb.com](http://www.salvoweb.com).

---

Interreg FCRBE partnership: Bellastock (FR), the Belgian Building Research Institute / BBRI (BE), Brussels Environment (BE), the Scientific and Technical Center of Building / CSTB (FR), Confederation of Construction (BE), Rotor (BE), Salvo (UK) and University of Brighton (UK).

The information contained in this document does not necessarily reflect the position of all the FCRBE project partners nor that of the funding authorities.

Unless explicitly stated otherwise, the content of these sheets is credited in the Creative Commons Attribution NonCommercial – Share Alike format (CCBY-NC-SA).



Unless explicitly stated, the images used in this document belong to © Rotor vzw/asbl or © Opalis. Any other image has been the subject of a systematic request for authorisation from their authors or rightful owners. When this request has not been answered, we assumed that there were no objections to the use of the image. If you feel that this interpretation is unreasonable, please let us know.



**Product description**

**Sheet metal radiators and convector heaters are very common heating elements in central heating installations. These are devices in which hot water circulates and which return the heat through convection and/or radiation. They have a lower thermal inertia than cast iron radiators.**

The first models of radiators, in cast iron, were gradually replaced, from the 1970s, by models made from sheet steel. More recently, devices made out of aluminium (lighter, faster temperature rise) and stainless steel (good corrosion resistance) have appeared on the market.

Sheet steel radiators come in a wide variety of shapes: section radiators, panel radiators, 'designer' radiators, baseboard heaters, towel radiators, vertical tube radiators, etc. The reuse of cast iron radiators differs from sheet metal appliances and is covered by the Cast iron radiators sheet.

The most common and cheapest heaters are panel radiators, both on the new and reclaimed market. They consist of one to three plates in which water circulates vertically (radiant heat), possibly reinforced by convection slats (convection heat). Depending on the number of panels and the number of convector elements, panel radiators are classified into several types (Figure 1). Decorative elements (front panel, side panels, upper grille) can complete the equipment.

The replacement of a heating appliance is more often linked to the replacement of the heating production system or to an aesthetic choice than to a malfunction of the appliances. Sheet metal radiators are most often used in single-family homes and medium-sized administrative buildings.

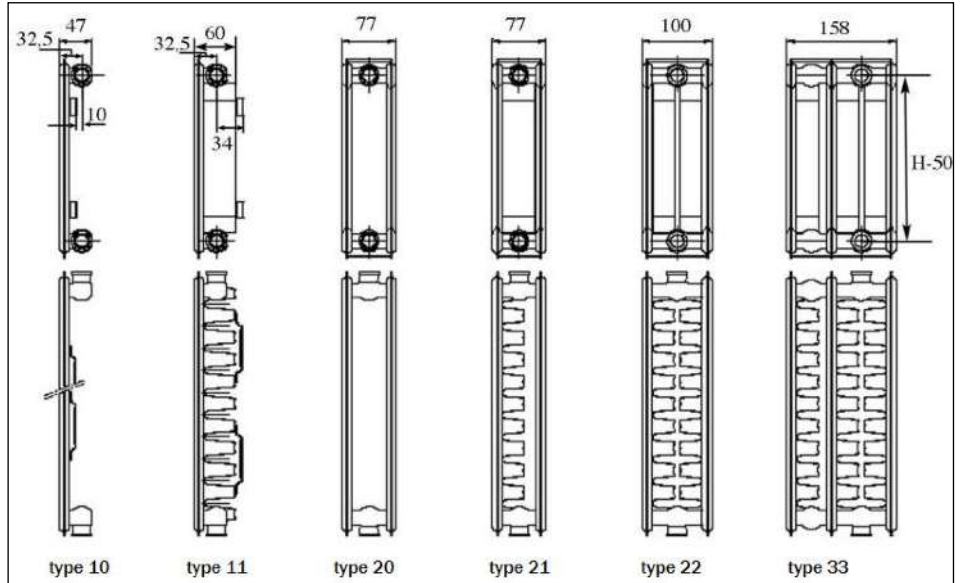

Figure 1: Types of panel radiators







## Sheet steel, stainless steel, and aluminium radiators

### Product reclamation

**If the appliances do not find a new use directly on site, they can be sent to professional reclaimed channels. However, there are only a few operators capable of salvaging batches of sheet metal radiators/convectors. Their interest will depend essentially on the model, the quantities and the general condition of the batch.**

→ **Dismantling test** (or expert opinion): in practice it makes it possible to ensure the feasibility and profitability of a removal. An 'expert eye' generally makes it possible to estimate the interest of a batch based on photos or existing technical information (manufacturer, model, dimensions, power, etc.), or through an on-site visit. The focal points will be among others:

- *general condition of the batch: are the appliances damaged? Dirty? Is the coating layer in good condition? Rust spots or water under the radiator can indicate a leak and spherical welds can betray a radiator that has frozen.*
- *Condition of the accessories: is the thermostatic valve working correctly? Condition of thermostatic valve stem and gland? Condition of the trim elements and the upper grille? Condition of the fixing bracket? Compatibility with new accessories?*
- *Commercial interest (depending on model, quantity, resale potential, ease of maintenance, etc.);*
- *Logistic arrangements (deadline, working time, handling, transport, etc.).*

→ **Dismantling**: careful dismantling should aim to ensure the integrity of the installation, the appliance and its accessories. After having drained the installation, it is recommended to first remove the thermostatic valve and the mounting brackets. Radiators that have had frozen water, or have cracks, traces of rust or deformation at the welds, are likely to be leaky and must be set aside. The radiators will be sorted by qualities, colours and dimensions. The specific mounting brackets will be retained.

→ **Storage**: the radiators should preferably be stored in a vertical position on a flexible support (wood) to avoid scratches and knocks. They will be filled with water (+ caps) to limit internal oxidation and stored in a dry place, protected from frost and protected from dust.

→ **Treatments**: in general, used sheet steel radiators are sold without any treatment other than surface cleaning. Unlike cast iron radiators, used sheet steel radiators very rarely benefit from a leak test and pressure resistance.

→ **Transport and delivery**: the necessary precautions must be taken during transport and delivery in order to limit knocks and scratches (interlayer protection, corner protectors, strapping of pallets, etc.).

It is advisable to involve specialised professionals to ensure the smooth running of these operations.



*Certain sheet steel radiator models can be confused with cast iron radiators.*





**Applications and installation**

As a general rule, the choice of heating appliances must take into account the expected stresses (see § 'characteristics and fitness for use') and factors such as aesthetics, thermal comfort, etc. In all cases, reference should be made to the European and national standards relating to the product (EN 442-1) and to the rules of practice in force (or implementation standards).

The design of a heating system based on reclaimed radiators differs from the design with new elements. Instead of ordering radiators that deliver the exact power required, you have to deal with appliances available on the reclamation market. The design must therefore be flexible with regard to the size and possible number of radiators.

→ **Power required:** this data determines the heat requirement of the rooms to be heated. This is determined by the climatic zone in which the building is located, the type and volume of the rooms, the general insulation of the building, the operating mode of the heat production, etc.

→ **Nominal power of a radiator:** this parameter determines the capacity of a radiator to emit heat. It is ascertained by the type of radiator (material, dimensions, number of panels and fins, level of contamination, etc.) and by the operating mode of the heat production. This information is sometimes available from the original manufacturer. In the event that the manufacturer is not known or that the calculation conditions are modified (for example in the case of an operating mode at low temperature), it is possible to obtain this information from charts available on the Internet or by calling a professional.

→ **Sizing of the radiators:** this calculation takes into account the required power, the nominal power of the radiators and their size, the available space, etc. In the absence of a thermal performance test, it is advisable to increase the dimensions of reclaimed radiators by 10%.



The reuse of reclaimed sheet radiators is no different from that of new radiators. They lend themselves to the same variety of installation methods (wall bracket, support feet). They raise the same points of attention, in particular: thermal power, connection possibilities, sealing of the radiator and connections, conformity of the accessories (thermostatic valves, bleed screws, plugs), aesthetics, safety (rounded corners), heat reflecting surface behind the radiator, etc. To facilitate installation, the designer/specifier will ensure that radiators meeting the following characteristics are used.

→ **Types and dimensions:** they must correspond to the needs expressed by the designer/specifier in order to obtain the desired thermal power.

→ **Condition:** reclaimed sheet steel radiators must not have cracks or alterations at the welds but may present alterations such as traces of superficial wear, stains, defective accessories, etc. Specialised workshops are able to carry out stripping and repainting.

*The presence of corrosion sludge or lime deposits inside radiators is frequent and is sometimes responsible for a decrease in thermal performance. It is therefore recommended to properly clean the inside of a used radiator before putting it back into operation (chemical or mechanical sludge removal/descaling).*

→ **Quantity:** to increase the chances of meeting the offer available on the reclaimed market, the designer/specifier can choose to split the batch with different models.

→ **Accessories:** connection parts, washers, valves, thermostatic valves, drain valves and fixing systems may be specific. If they need to be replaced, ensure the compatibility of the appliances with new accessories. Some accessories are sometimes available from professional dealers.

Most of the reclaimed building materials are sold as is. The conditions of sale may however contain special guarantees specific to the material. Some suppliers are able to indicate the origin of the material and/or provide documentation on the product purchased (for more information, see the introductory sheet).



Illustrated manual for dismantling a radiator (in French): <https://reuse.brussels/nl/radiateurs-et-vannes-thermostatiques/>



**Characteristics and fitness for use**

The harmonised European standard EN 442 establishes the relevant characteristics (depending on the context) to be observed in order to determine the fitness for use of radiators and convector heaters. Although detailed for new materials produced from 2002 onwards, these characteristics may prove useful in considering the specific case of reclaimed radiators.

Characteristics	Comments
<b>Reaction to fire</b>	The reaction to fire of a sheet metal radiator depends primarily on the thickness of the surface coating. The original paint coat generally complies with the standards in force (thickness < 1 mm and surface density 1 kg/m <sup>2</sup> ). In the absence of proven additional paint coats, reclaimed radiators can be classified as non-combustible and belong to the European reaction to fire class A1 without prior testing.
<b>Emission of hazardous substances</b>	A lead diagnosis may be necessary to detect the presence of old lead paints on radiators (before 1990). In this case, it is strongly recommended to strip and paint the radiators. Specialised workshops are able to provide this service.
<b>Sealing and pressure resistance</b>	The radiator must be able to withstand a pressure 1.69 times the maximum operating pressure. Unlike cast iron radiators, used sheet metal radiators are very rarely pressure tested. It is therefore advisable to visually inspect the radiators to detect the possible risks of leaks. Information on storage conditions and the risk of freezing before removal is relevant in this regard (to be requested from the supplier or to be noted on site).
<b>Surface temperature</b>	/
<b>Thermal power and characteristic curve</b>	<p>The exact thermal power of a used radiator cannot be calculated according to the tests described in standard EN 442-2. It is ascertained by the type of radiator (material, dimensions, number of panels and fins, level of contamination, etc.) and by the operating mode of the heat production. This information is sometimes available from the original manufacturer. In the event that the manufacturer is not known or that the calculation conditions are modified (for example in the case of an operating mode at low temperature), it is possible to obtain this information from charts available on the Internet.</p> <p>The presence of corrosion sludge or lime deposits inside radiators is frequent and is sometimes responsible for a decrease in thermal performance. It is therefore recommended to properly clean the inside of a used radiator before putting it back into operation (chemical or mechanical sludge removal/descaling). It is also advisable to increase the dimensions of reclaimed radiators by 10% when calculating the sizing of radiators.</p>
<b>Corrosion resistance</b>	For new products, this characteristic is tested by verifying the absence of surface corrosion after 100 hours of exposure to humidity. This characteristic is therefore closely linked to the degree of sorting of reclaimed sheet metal radiators. A visual or detailed examination is often sufficient to estimate it.
<b>Resistance to small impacts</b>	/





**Embodied carbon (Cradle to gate – production A1-A3)**

	kg CO <sub>2</sub> eq./FU
INIES database (FR) – Generic data *	197
UNICLIMA – Collective declaration **	98.3

\* Indicative value for FU (Functional Unit) = 1000 W hot water radiator for a reference life of 50 years.

\*\* Indicative value for FU (Functional Unit) = 1000 W hot water radiator for a reference life of 50 years. Steel radiator consisting of type 21 or 22 tubes or panels. Surface treatment and finish coating with anti-corrosion epoxy paint. Mass: 31.74 kg.



Considering a required thermal power of 10 kW for an average home of 100 m<sup>2</sup>, reusing 10 sheet radiators of 1000 W can prevent the production of ~ 983 to ~ 1 970 kg of CO<sub>2</sub> eq. related to the manufacture of new radiators (production phase only). This corresponds to a journey of ~ 5 900 to ~ 11 800 km in a small diesel car.

**Availability**

Sheet metal radiators are an uncommon product on the reclamation market. Their availability depends on the quantities required. As an example:

Frequent	Batch of 1 piece
Occasional	Batch of 2 to 5 identical pieces
Rare	Batch of > 5 identical pieces

**Tip!**

To increase the chances of meeting the supply available on the reuse market, the designer/specifier may choose to split the large areas into smaller batches (e.g. with different models in each room).

**Indicative prices (excl. tax)**

The prices observed vary greatly depending on the model and the original manufacturer. Designer radiators, in aluminium or stainless steel are the most popular. Panel radiator models that are easy to maintain (removable faces and grilles) are generally more expensive.

- Standard panel radiators: €40 to €150/unit
- Designer radiators: €150 to €200 /unit

At these prices, it is sometimes necessary to provide for a supplement for the replacement of washers or certain accessories, stripping and repainting, sludge removal/descaling, etc.

**Hazardous substances and precautions**

**Lead:** a lead diagnosis may be necessary to detect the presence of old lead paints on radiators (before 1990). In this case, it is strongly recommended to strip and paint the radiators. Specialised workshops are able to provide this service.

**Find specialised businesses**



salvoweb.com

[salvoweb.com](http://salvoweb.com)



opalis.eu

[opalis.eu](http://opalis.eu)





# CEMENT CONCRETE PRODUCTS



- *Introduction to the reuse of cement concrete products*
- Concrete rubble
- Concrete pavers and slabs
- Concrete shear wall



**Disclaimer**

This sheet is intended for designers, specifiers and other members of construction project teams wishing to reuse this building material or product. It is part of a collection of sheets aimed at bringing together the available information to date that is likely to facilitate the reuse of building materials and products.

This sheet has been produced by Bellastock within the framework of the Interreg FCRBE project - Facilitating the Circulation of Reclaimed Building Elements, supported by the entire project partnership. Sources of information include the experience of reclamation dealers and involved project partners, lessons learned from exemplary projects, available technical documentation, etc.

The sheets have been produced between 2019 and 2021. As the reclamation sector is evolving, some information, notably regarding pricing and availability, may change over the time. When the text refers to European standards, it is up to the project team to refer, if necessary, to their national implementations and local specificities.

It is important to note that the information presented here is not exhaustive or intended to replace the expertise of professionals. Specific questions are always project related and should be treated as such.

The complete collection of sheets (including the introductory sheet) is freely available from different reference websites (a.o. [opalis.eu](http://opalis.eu), [nweurope.eu/fcrbe](http://nweurope.eu/fcrbe), [futureuse.co.uk](http://futureuse.co.uk)).

Non-exhaustive directories of dealers in reclaimed building materials are available on [www.opalis.eu](http://www.opalis.eu) and [www.salvoweb.com](http://www.salvoweb.com).

---

Interreg FCRBE partnership: Bellastock (FR), the Belgian Building Research Institute / BBRI (BE), Brussels Environment (BE), the Scientific and Technical Center of Building / CSTB (FR), Confederation of Construction (BE), Rotor (BE), Salvo (UK) and University of Brighton (UK).

The information contained in this document does not necessarily reflect the position of all the FCRBE project partners nor that of the funding authorities.

Unless explicitly stated otherwise, the content of these sheets is credited in the Creative Commons Attribution NonCommercial – Share Alike format (CCBY-NC-SA).



Unless explicitly stated, the images used in this document belong to © Bellastock. Any other image has been the subject of a systematic request for authorisation from their authors or rightful owners. When this request has not been answered, we assumed that there were no objections to the use of the image. If you feel that this interpretation is unreasonable, please let us know.

**Iconography**

Figure 1 : BENOIT J, SAUREL G, BILLET M, BOUGRAIN F, LAURENCEAU S, ADEME, BELLASTOCK, CSTB, *REPAR#2 Le réemploi passerelle entre architecture et industrie*, mars 2018, p108.





## Introduction

This set of sheets ("*1.90. Concrete pavers and slabs resulting from the transformation of concrete construction elements*", "*2.91. Concrete shear wall*" and "*2.92. Concrete rubble resulting from the transformation of concrete construction elements*") aims to present several possibilities for the reuse of cement concrete elements.

This sheet introduces the basic precepts. It endeavours to describe the material in general. It then identifies the main families of elements with potential for reuse. The other sheets study in more detail the ways of re-using specific elements.

In general, this set of sheets covers the constituent elements of the structure and the building's envelope.

## Material description

Cement concrete (called "concrete" in the rest of the documents) is a composite material, obtained by mixing:

- *sand*
- *gravel*
- *cement* (composed of limestone and crushed clay, fired at a very high temperature and then crushed)
- *water*

The proportions are variable depending on the intended use. Adjuvants can be added to its formulation to give it specific properties (e.g. setting or hardening accelerator or retarder, modification of workability, etc.).

Concrete has good compressive strength but not tensile strength. To overcome this, it is often coupled with steel. We then talk of reinforced concrete.

Today, second only to water, concrete is the most consumed material, with three tonnes per year used for every person in the world<sup>1</sup>.

Concrete as we know it and use it today is the result of experiments and technological developments that have mainly taken place over the last century. The intense period of reconstruction that followed the Second World War was decisive for the concrete industry: countless inventions and construction methods arose. These developments were supported by countries, which aimed to

achieve efficiency gains and savings. In France, this is the time when the "large complexes" were built, giving pride of place to concrete poured in place or prefabricated. During this period, those involved in construction specialised in concrete masonry. More recently, high-performance concretes have appeared incorporating new components such as fibres in their formulation.

Behind a single term there are a multitude of concrete types and applications. However, it is possible to establish a few broad categories:

→ *According to the concrete types*

- **Reinforced concrete** is the most common form in which the steel/concrete combination is found. This is a concrete which includes steel reinforcements, the arrangement, sections, distribution, anchors, and adhesion of which differ according to the forces to be taken up.
- **Fibre-reinforced concrete** (or fibre concrete) is concrete in which fibres have been incorporated (stainless steel, polypropylene, spun glass, carbon, etc.) which make it possible to create a mesh that increases the cohesion and resistance capacities of the concrete.
- **Prestressed concrete** is concrete to which a permanent compressive force is applied before it is put into service, so that it is not subjected to tensile forces once in service. This compressive force is obtained by the tensioning of reinforcements, after the pouring of the concrete (post-stress) or before the pouring (pre-tension).

→ *According to the installation techniques*

- **Precast concrete:** these are components produced outside their final location (in the factory, in the workshop, near the construction work or on a prefabrication area) then assembled on site. The elements are linked by a keying and concreting system which ensures the consistency and stability of the whole. Many prefabrication processes have emerged. The regular use of prefabricated concrete elements became widespread after World War II, in a context of large-scale reconstruction. Prefabrication is still used today, but in a more targeted way (façade panel, structural elements, etc.).

- **Concrete poured-in-place:** concrete cast in formwork by gravity. Depending on the size and context of the site, concrete can be produced in a concrete batching plant at the foot of the site or on a dedicated site. There is standard reusable formwork and custom formwork in the case of a complex shape. Depending on the position of the building element cast in place and its structural role, it will be more or less scrapped.

Today, concrete is not a material that can be found on the reclamation market. Some suppliers of reclaimed materials offer manufactured concrete pavers, slabs or roofing tiles, but not elements from the actual structure of the buildings. To date, steps to reuse concrete elements have therefore been carried out on the initiative of sponsors and designers. Nevertheless, the recovery and dealer networks of concrete elements are likely to develop in the future.

At this stage, several experiments have already demonstrated the possibility of re-using concrete elements from demolished buildings, for the same use or for other applications (see sheets "*1.90. Concrete pavers and slabs resulting from the transformation of concrete construction elements*", "*2.91. Concrete shear wall*" and "*2.92. Concrete rubble resulting from the transformation of concrete construction elements*"). These different experiences highlight a range of possible reuse solutions, which are all alternatives to recycling (i.e. crushing concrete into aggregate).

<sup>1</sup> Gagg (2014), *Cement and concrete as an engineering material: An historic appraisal and case study analysis*, *Engineering Failure Analysis*, Volume 40, p. 114-140.



**Do not confuse!**

**Concrete reuse and recycling**

Once purged of its reinforcements and any coating, concrete is an inert material. On a good number of sites, the demolishers expose the concrete frames which are then demolished. The resulting rubble is crushed to make recycled aggregates. Depending on their quality and grain size, they can be used in road or backfill applications. Some aggregates can be incorporated into the production of new concrete - but only to a limited extent.

All of these approaches correspond to recycling practices. Reuse, unlike crushing, involves reuse of a building element while preserving its formal integrity, technical and architectural qualities as much as possible.

**Identification of concrete elements that can be reused in construction (typological description of constituents)**

The reuse of concrete is an ambiguous notion, which is why we rather speak of the reuse of concrete elements. A good knowledge of construction methods is necessary to determine the feasibility of reuse and target possible future uses.

In practice (see figure 1), the majority of the most commonly used elements in concrete constructions can be reused:

→ **Posts**: elongated, vertical load-bearing elements. They mainly take up the compressive forces transmitted vertically from the upper floors to the ground through the foundations. The most common sections are square, rectangular, circular, or I-sections.

→ **Beams**: long pieces whose function is to transfer loads (mainly vertical) to supports. They have standard rectangular sections and are reinforced so as to take up bending moments (longitudinal steel bars) and shearing forces (frames).

→ **Walls**: these are vertical structural surface works. They mainly support vertical loads. Due to their great rigidity, walls are also used to take up horizontal stresses (wind, earthquake). A concrete wall is considered as such when its length is at least equal to 4 times its thickness.

→ **Concrete floors**: these are load-bearing horizontal surface elements, mainly subjected to bending. A distinction is made between slabs with unidirectional spans and slabs with bidirectional spans. These floors are found in three main groups: solid slabs,

ribbed slabs and special (mixed) floors. A slab is an element whose smallest dimension in its plane is greater than or equal to 5 times its total thickness. They are usually reinforced with welded mesh.

→ **Facade panels**: flat and relatively thin material of uniform thickness. These elements are used for filling most of the time and have no structural role.

**Tip!**

To understand the possibilities of reusing concrete elements, it may be useful to conduct an investigation into the history of the building from which they originate as well as its historical construction context. The analysis of archival documents, files of works executed and works on the history of construction makes it possible to identify and better understand the construction processes used. In addition to this documentary study, visual observation in the field, possibly supplemented by surveys, is essential in assessing and completing the analysis.

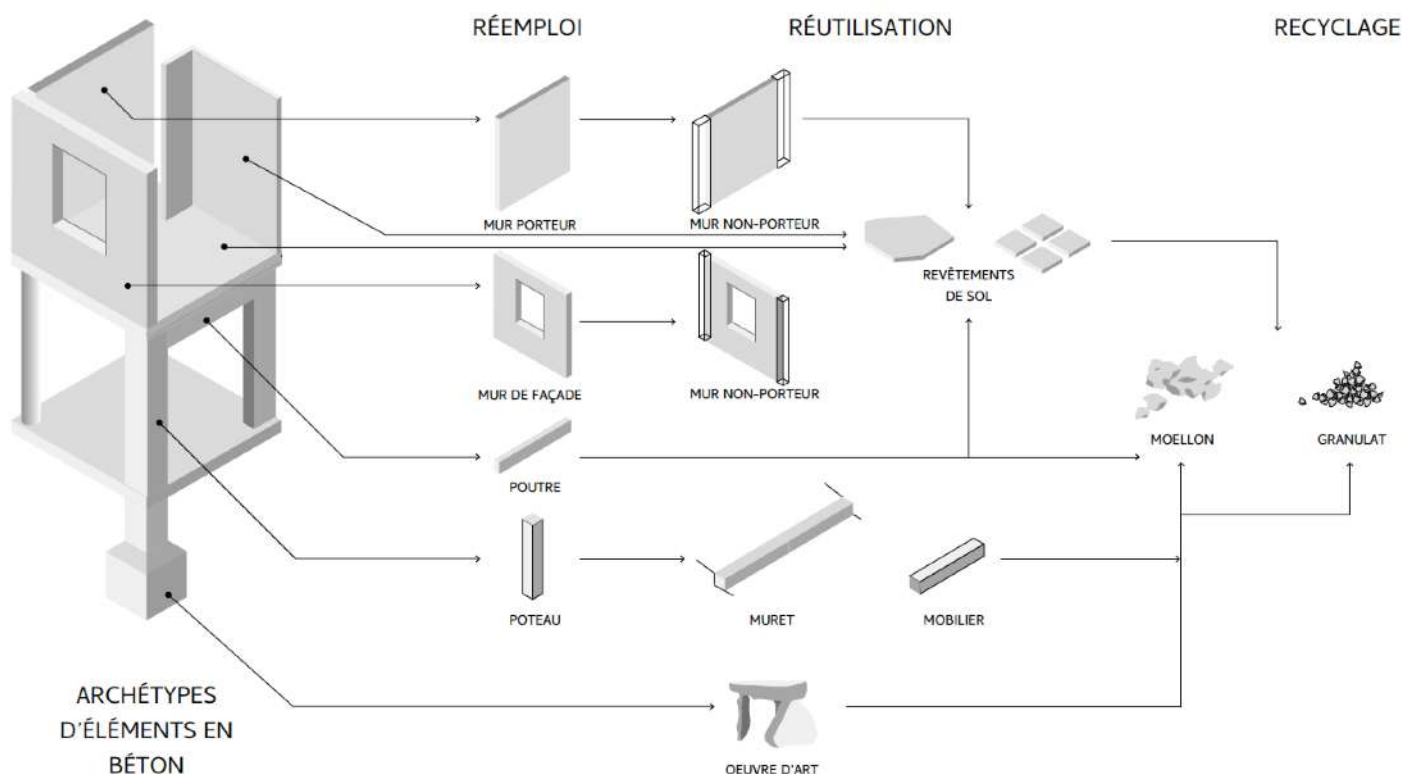

Figure 1: Main re-use and re-purposing possibilities for concrete elements



### Main properties of reclaimed concrete elements

Whatever element one wishes to re-use, and whatever the new expected use, the basic characteristics to be understood to allow the sizing studies of future structures are:

→ *For concrete:*

- The physico-chemical composition.
- The compressive strength class. The tensile strength.
- The exposure class (linked to region, altitude and exposure to bad weather).
- The dimensions.

→ *For steel:*

- Mechanical properties: yield strength, tensile stress, relative elongation of tensile steel and modulus of elasticity.
- The dimensional characteristics: the position of the reinforcements, the diameter of the bars, the nature of the steel and the coating.

All the properties of reclaimed concrete must comply with the requirements applied to new concrete.

The diagnosis and more or less thorough analysis of the properties go towards deciding on the size according to the context of the project and the intended use. Over-sizing or downgrading of materials can be a design strategy to address knowledge gaps about the properties or deterioration of a building element.

Grading of concretes can be done by iteration, for example by carrying out measurements on site to obtain information on the hardness. A visual diagnosis makes it possible to identify the condition of the surfaces. The diagnostic tools and methods used by designers/specifiers working in the contexts of heritage concrete buildings can be called upon as part of a reuse process.

### Calculations and main standards

→ *Design standards:* national regulations and Eurocodes.

→ *Installation standards:* standards and good practice on a national level (e.g.: NIT, DTU, etc.) and the standard EN 13670: Execution of concrete structures.

→ *Product standards:* relating to precast concrete products (structural and non-structural).

→ *Test standards:* in the case of reuse, mainly concerns test standards related to determining the properties of hardened concrete.





### Disclaimer

This sheet is intended for designers, specifiers and other members of construction project teams wishing to reuse this building material or product. It is part of a collection of sheets aimed at bringing together the available information to date that is likely to facilitate the reuse of building materials and products.

This sheet has been produced by Bellastock within the framework of the Interreg FCRBE project - Facilitating the Circulation of Reclaimed Building Elements, supported by the entire project partnership. Sources of information include the experience of reclamation dealers and involved project partners, lessons learned from exemplary projects, available technical documentation, etc.

The sheets have been produced between 2019 and 2021. As the reclamation sector is evolving, some information, notably regarding pricing and availability, may change over the time. When the text refers to European standards, it is up to the project team to refer, if necessary, to their national implementations and local specificities.

It is important to note that the information presented here is not exhaustive or intended to replace the expertise of professionals. Specific questions are always project related and should be treated as such.

The complete collection of sheets (including the introductory sheet) is freely available from different reference websites (a.o. [opalis.eu](http://opalis.eu), [nweurope.eu/fcrbe](http://nweurope.eu/fcrbe), [futureuse.co.uk](http://futureuse.co.uk)).

Non-exhaustive directories of dealers in reclaimed building materials are available on [www.opalis.eu](http://www.opalis.eu) and [www.salvoweb.com](http://www.salvoweb.com).

---

Interreg FCRBE partnership: Bellastock (FR), the Belgian Building Research Institute / BBRI (BE), Brussels Environment (BE), the Scientific and Technical Center of Building / CSTB (FR), Confederation of Construction (BE), Rotor (BE), Salvo (UK) and University of Brighton (UK).

The information contained in this document does not necessarily reflect the position of all the FCRBE project partners nor that of the funding authorities.

Unless explicitly stated otherwise, the content of these sheets is credited in the Creative Commons Attribution NonCommercial – Share Alike format (CCBY-NC-SA).



Unless explicitly stated, the images used in this document belong to © Bellastock. Any other image has been the subject of a systematic request for authorisation from their authors or rightful owners. When this request has not been answered, we assumed that there were no objections to the use of the image. If you feel that this interpretation is unreasonable, please let us know.

### Iconography

Figure 1 : BENOIT J, SAUREL G, BILLET M, BOUGRAIN F, LAURENCEAU S, ADEME, BELLASTOCK, CSTB, *REPAR#2 Reuse as a bridge between architecture and industry*, March 2018, p108.



**Concrete rubble**

(resulting from the transformation of concrete construction elements)

Material description

**Material description**

**This sheet describes a process consisting in reusing certain types of concrete rubble from the demolition of buildings as rubble for the construction of retaining walls, fences, gabions and other landscape applications - works traditionally made of natural stone.**

A priori, all the concrete elements present in a building are likely to provide an adequate resource for producing rubble. The best candidates are concrete rubble resulting from the demolition and prior to the crushing phase and containing no (or very little) reinforcement (in order to limit the risk of injury during handling).

The rubble from walls and slabs produces blocks characterized by two flat faces. They thus have regular and flat laying surfaces. Although columns and beams originally also have flat faces, their demolition generally results in more irregular blocks, the size of which corresponds to the volume between reinforcements (depending on their size and the position of the bars).

Reusing this rubble as blocks differs in several ways from crushing concrete to produce recycled aggregates (which, to this day, remains the most common treatment method for concrete scrap). Indeed, the direct reclamation of blocks does not involve crushing the rubble, which therefore retains relatively large dimensions (where crushing tends to reduce them to a much finer grain size).



Concrete rubble deposit from the demolition of a tower at Clos Saint Lazare in Stains (FR).

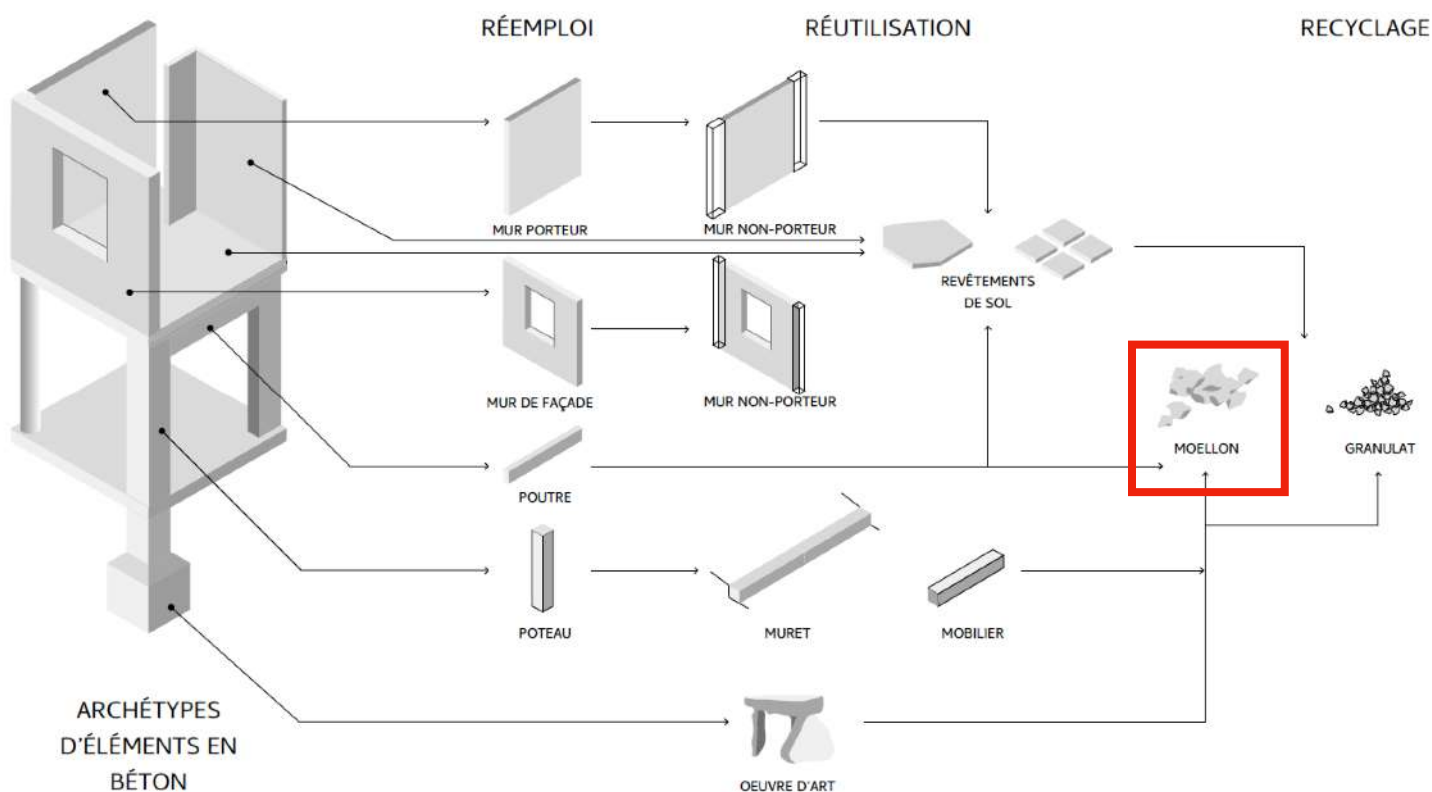

Figure 1: schematic diagram presenting possible reclaim solutions from a typical deposit.



## Material reclamation

**The recovery of concrete rubble on a demolition site takes place between the demolition of the building and the crushing of the rubble. It is based on a succession of stages:**

→ *Diagnosis and preliminary studies.* The prior identification of the construction elements makes it possible to anticipate the possible shapes of the rubble blocks. The assistance and advice of concrete specialists as well as documentation available on the building to be demolished can also provide useful information.

These preliminary studies must also make it possible to assess the feasibility and the advisability of recovering the rubble according to the volume of concrete to be demolished, the site configuration, the quantity of reclaimed materials to be extracted and other contingencies linked to the project. Given the still experimental nature of this type of approach, it is wise to rely on the advice of demolition companies. If necessary, transformation tests can be carried out during the demolition site phase to adapt the proposed technical solution.

→ *Collection.* The collection of rubble can be done in two ways:

- Sorting during the demolition phase, then transformation at the end of the site to obtain the desired rubble.
- Sorting of rubble after or during demolition.

In both cases, the use of suitable screening increases the yield.

→ *Transformation.* The transformation of concrete blocks is generally quite light. It mainly consists of adapting their shape during installation. It can also include actions to control and remove residual reinforcement. For reasons of economy, it is advisable to rule out the elements whose transformation turns out to be too complex. For this, it is recommended, if the organization of the project allows it, to involve the operator responsible for laying the blocks.

→ *Storage.* The storage conditions must be defined with regard to the overall organization of the site, the intended use of the materials and the volume to be stored.

For on-site use with site demolition in progress, we will prefer storage in an isolated merlon, as close as possible to the structure's location. The installation of cells makes it possible to increase the density of the stock and to limit its footprint on the ground.

→ *Transport and delivery.* Concrete fragments can be transported by dumper or dump truck and deposited in elongated piles (merlon) on the new site to facilitate access to materials.

It is advisable to involve specialised professionals to ensure the smooth running of these operations.

## Applications and installation

**Reclaimed concrete blocks are mainly used in landscaped masonry such as walls and garden walls. It is advisable to rely on the technical references relating to the installation of the type of work to be carried out (for example, in France, the Professional Rules: *Installation of landscaped walls, soil retaining structures and stairs No.: CC4-R0*).**

The landscaped walls and low walls are made with blocks stacked one on top of the other. These can be irregular or have one or more flat faces. Concrete blocks must be laid flat. Their length should not exceed a quarter or a fifth of their height.

As with natural stone walls, the laying of concrete blocks can be dry or sealed.

The shape of the reclaimed concrete blocks and their dimensional regularity can influence the bonding choice. Conversely, the expected regularity at the level of the joint can influence the choice of the shape of the blocks.

In any case, it should be ensured that the stone elements are correct on all sides. Concrete blocks should be laid alternately in several rows, so that each vertical joint rests on one block. There should not be more than three joints at a time that intersect one by one on the front and back sides. It is also necessary to avoid that a sharp joint does not cross more than two beds. It should also be ensured that there is at least one kicker block for two facing blocks or that the kicker and facing blocks alternate. The largest blocks should be placed in the corners.

To facilitate laying, the designer will take care to use batches with a certain degree of uniformity in terms of the following characteristics:

→ *Batch composition.* The rubble must have uniform characteristics. This may involve the implementation of a principle of traceability to ensure that all the rubble comes from the same origin.

→ *Dimensions.* The geometry of the elements can be specified in order to facilitate handling (ensure that each block weighs less than 25 kg, for example). Depending on the chosen installation, it may be requested that the blocks have two flat faces. Other requirements may be indicated here if the project provides for a particular treatment of infill, corner or even crown stones.

→ *Condition.* Concrete rubble may have minor alterations such as traces of superficial wear, stains, traces of mould, efflorescence, etc. On the other hand, they cannot have any defect indicating a heterogeneity of the structure, nor visible cracking, chipping, deformation, or tearing.





### Characteristics and fitness for use

The requirements relating to the physical and mechanical characteristics are directly linked to the mechanical strength of concrete blocks over time .

Regarding the mechanical properties of modular concrete elements, the normative requirements come from DTU 20.1 *Building work - masonry works of small elements - Partitions and walls* (French standard).

Characteristics	Comments
<b>Dimensions (length, width), regularity of shape</b>	<p>For the infill rubble:</p> <ul style="list-style-type: none"> <li>→ Concrete rubble must be handled manually (weight &lt; 25 kg)</li> <li>→ No reinforcement must protrude from the edges of the rubble</li> <li>→ The faces must be perpendicular for the layout plan</li> <li>→ The faces must be flat.</li> </ul> <p>For corner and crown blocks:</p> <ul style="list-style-type: none"> <li>→ No reinforcement should protrude from the edges of the stone</li> <li>→ Blocks with straight edges to ensure a keying on the periphery of the wall</li> </ul>
<b>Block thickness</b>	<p>Tolerated variations:</p> <ul style="list-style-type: none"> <li>→ the thickness of the kicking blocks must be equal to approximately one and a half times the height of the bed, and at least equal to 30 cm.</li> <li>→ the thickness of the blocks used for cladding must be approximately equal to the height of the bed.</li> <li>→ joint thickness ≥ 10 cm for a structure made up of block beds.</li> </ul>
<b>Surface quality</b>	Concrete blocks showing defects characteristic of a non-uniform structure or showing visible cracks, chipping, deformation or tearing must be rejected.
<b>Impermeability/Water absorption</b>	Porosity according to EN 1936. Determining resistance to water absorption is not required for the first marking designation defined by standards EN 1338 and EN 1339.
<b>Steel</b>	Concrete rubble should not have visible iron.

However, in the event of specific and demanding applications, parameters related to characteristics such as mechanical resistance, frost resistance or impermeability can be measured and quantified using tests carried out by accredited laboratories.

<b>Embodied carbon (Cradle to gate - production A1-A3)</b>	kg CO <sub>2</sub> eq./m <sup>2</sup>	kg CO <sub>2</sub> eq./kg
INIES database (FR) - Individual Declaration - ALBAMIEL - Natural stone walls 15 to 45 cm thick (v.1.1) *	11,4	0,02
INIES database (FR) - Collective declaration - Association Pierres du Sud - Wall in « Pierre du Midi » (v.1.2) ***	12,2	0,02
INIES database (FR) - Collective declaration - CERIB - Concrete block (laying with thick joints) (v.1.8) ***	30,6	0,14

\* Natural stone wall from 15 to 45 cm. Transport: 1623km.

\*\* Load-bearing wall in solid stone 40 cm thick. Transport: 100km.

\*\*\* Hollow concrete block B40, 20 x 50 x (20 à 25 ht) laid with thick joints (or masonry installation) Distance travelled by the product: 57km

NB: the production steps (A1-A3) of the mortar have been added, when these were not taken into account in the sheet.

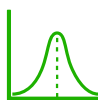

According to these sources, the construction of 100 m<sup>2</sup> of landscaped masonry in reclaimed concrete rubble prevents the production of ~ 300 kg of CO<sub>2</sub> equivalent related to building a wall from new concrete blocks. This corresponds to the emissions caused by a small diesel city car during a trip of ~ 18 350 km.



### Availability

Reclaimed concrete blocks are not a commercial construction product. However, since this material is obtained from the recovery of concrete rubble (which constitutes the main fraction of demolition waste), its potential availability is high. Virtually every demolition operation is likely to produce some. In this regard, it is not impossible that this product complements the ranges of concrete aggregates resulting from the crushing of demolition waste.

### Hazardous substances and precautions

During documentary investigation, certain usage restrictions may be issued, in particular in the following cases:

→ Concrete that has been subjected to chemical attack by soils and natural groundwater (corresponding to the three exposure classes XA1, XA2 and XA3 of standard NF EN 206)

→ Possible presence of plaster residues in the concrete, a priori incompatible with reclaim as a floor covering. In fact, the presence of water during the use of the pavers will very probably lead to the formation of swelling mineral species such as ettringite, which will eventually lead to significant degradation of the pavement or the slab.

→ Possible presence of asbestos on the surface of the concrete wall (fireproof insulation on the façade, joint, interior coating glue, etc.). Prior asbestos removal from the building can make it possible to clean the concrete elements of asbestos residues, a concrete element installed in contact with asbestos should not automatically be disqualified for reclaim at the diagnostic stage.

#### Inspiration!

As part of the « Clos factory project » in the Clos-Saint-Lazare district in Stains (Seine-Saint-Denis, France), two types of installation were tested: dry installation and sealed installation.

For the first version, the concrete rubble wall was installed without sealing mortar, then coffered on 3 of its sides. The company then produced a self-compacting concrete to seal the stones on the invisible part, as well as giving it a coating. This gives a protruding stone effect with a hollow joint.

For the second version, a peripheral formwork was made, and once it was filled with loose rubble, a self-compacting concrete was poured. The faces were then staked until the rubble was visible.

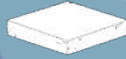

Landscape masonry in concrete rubble resulting from the demolition of a housing building built between 1966 and 1970. The Clos factory is a demonstration site of the potential for reusing concrete elements resulting from demolition. It was fitted out and built from materials resulting from the demolition of buildings as part of the Clos-Saint-Lazare urban renewal project.

**Disclaimer**

This sheet is intended for designers, specifiers and other members of construction project teams wishing to reuse this building material or product. It is part of a collection of sheets aimed at bringing together the available information to date that is likely to facilitate the reuse of building materials and products.

This sheet has been produced by Bellastock within the framework of the Interreg FCRBE project - Facilitating the Circulation of Reclaimed Building Elements, supported by the entire project partnership. Sources of information include the experience of reclamation dealers and involved project partners, lessons learned from exemplary projects, available technical documentation, etc.

The sheets have been produced between 2019 and 2021. As the reclamation sector is evolving, some information, notably regarding pricing and availability, may change over the time. When the text refers to European standards, it is up to the project team to refer, if necessary, to their national implementations and local specificities.

It is important to note that the information presented here is not exhaustive or intended to replace the expertise of professionals. Specific questions are always project related and should be treated as such.

The complete collection of sheets (including the introductory sheet) is freely available from different reference websites (a.o. [opalis.eu](http://opalis.eu), [nweurope.eu/fcrbe](http://nweurope.eu/fcrbe), [futureuse.co.uk](http://futureuse.co.uk)).

Non-exhaustive directories of dealers in reclaimed building materials are available on [www.opalis.eu](http://www.opalis.eu) and [www.salvoweb.com](http://www.salvoweb.com).

---

Interreg FCRBE partnership: Bellastock (FR), the Belgian Building Research Institute / BBRI (BE), Brussels Environment (BE), the Scientific and Technical Center of Building / CSTB (FR), Confederation of Construction (BE), Rotor (BE), Salvo (UK) and University of Brighton (UK).

The information contained in this document does not necessarily reflect the position of all the FCRBE project partners nor that of the funding authorities.

Unless explicitly stated otherwise, the content of these sheets is credited in the Creative Commons Attribution NonCommercial – Share Alike format (CCBY-NC-SA).



Unless explicitly stated, the images used in this document belong to © Bellastock. Any other image has been the subject of a systematic request for authorisation from their authors or rightful owners. When this request has not been answered, we assumed that there were no objections to the use of the image. If you feel that this interpretation is unreasonable, please let us know.

**Iconography**

Figure 1 and Figure 2: BENOIT J, SAUREL G, BILLET M, BOUGRAIN F, LAURENCEAU S, ADEME, BELLASTOCK, CSTB, *REPAR#2 Le réemploi passerelle entre architecture et industrie*, mars 2018, p108.



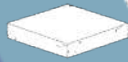

## Material description

The concrete pavers and slabs referred to in this sheet concern modular elements obtained by cutting, cleavage or fragmentation with a mechanical shovel of concrete elements having two flat and parallel faces (slabs, panels, trusses) and used as a paving product. The original elements undergo a transformation and a change of use. They are therefore different from pavers and concrete slabs which were initially produced for this purpose, and whose reuse is also possible (but not discussed here).

Pavers and slabs obtained by transforming concrete construction elements (hereinafter referred to as pavers and slabs) may be suitable for various outdoor applications: landscaping, building surroundings, roads and public spaces.

These are the dimensional aspects that distinguish slabs from pavers:

- any element whose overall length divided by its thickness is greater than 4 and whose length does not exceed one metre is considered to be a "slab".
- any element whose overall length divided by its thickness is less than or equal to 4 and at a distance of 50 mm from any edge is considered to be a "paver". No cross-section has a horizontal dimension less than 50 mm.

In practice, slabs and pavers cut from concrete elements may have irregular contours. They generally have sizes between 20 cm and 40 cm in order to facilitate handling.



Comparison of an irregularly shaped concrete slab resulting from a demolition operation and a new regular slab



At present, pavers and slabs resulting from the transformation of concrete construction elements are not marketed. This is an initiative led by sponsors and designers, most often taking advantage of opportunities present on or near the site.

Different types of concrete construction elements can be salvaged to produce slabs and pavers, in particular:

→ *Interior crosswalls cast in place*. These are structural walls positioned inside the building, perpendicular to the façade plane. These walls are generally 15 to 20 cm thick. Their height most often corresponds to that of a storey, i.e. around 250 cm in a residential building (for more details, see sheet "2.91\_Concrete shear wall").

→ *Prefabricated panels*. There is a wide variety of types of prefabricated panels. While some have significant thicknesses (> 15 cm) and contain a lot of reinforcement, others are thinner (~ 10 cm) and contain less (or no) reinforcement. This is particularly the case with panels used to make interior partitions. The latter are suitable for cutting into slabs and pavers (for more details, see sheet "2.91\_Concrete shear wall").

→ *Compression slabs on a shuttering slab floor system*. This is a floor system made up of a shuttering slab of variable thickness (minimum 5 cm in the case of prestressed materials) on which a compression slab is then cast (approximately 10 cm thick). The dimensions of the shuttering slabs depend on the floor span. On average, they have a width of 2.50 m and a maximum range of 5 m. This system can often be recognized by the smooth underside of the floor and the presence of a joint running perpendicular to the direction of the beams. However, a site visit may not be sufficient to identify this system with certainty. The study of the original documents (in particular the documents of works carried out) can then provide additional information.

Several aspects must be taken into account in order to identify the most suitable source elements, in particular:

→ *Thickness*. This must be sufficient to meet the constraints of installation and use of slabs and paving stones (see § "Applications and installation").

→ *Reinforcement*. The presence of reinforcement in the original elements tends to complicate the process of removing, transforming and reinstalling slabs and pavers. Therefore, it is more interesting to focus on elements with little or no reinforcement (generally the interior walls).

→ *Surface condition*. If necessary, surface treatments may be considered to adapt the properties of the surfaces.

→ *Logistical considerations*, particularly in terms of accessibility, handling and site planning.

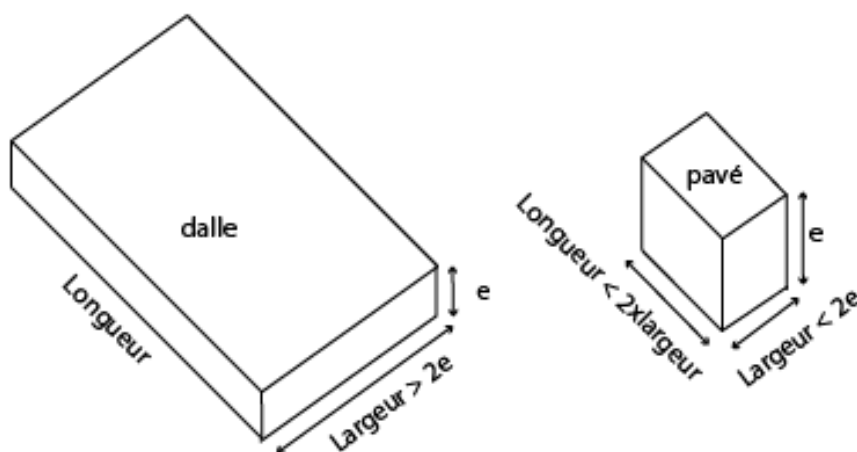
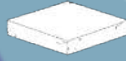

Figure 1: Geometric characteristics of a slab and a paver



## Material reclamation

### Before being reinstalled, slabs and pavers made from concrete construction elements go through several stages:

1. Preliminary studies.
2. Removal of original elements.
3. Transformation of the original elements into slabs or paving stones.
4. Complementary treatments.
5. Storage and transport.

Some of these steps, in particular removal and conversion, involve relatively heavy mechanical means. They require good preparation and excellent coordination with demolition works. The targeted elements must in fact be carefully extracted from the building and then transformed on land. This involves cutting operations on site (in particular for exposing keying steel binding prefabricated elements) and the use of lifting devices (with, if necessary, the installation of anchor points to allow fixing the slings).

In all cases, it is a question of putting in place all the necessary precautions in conjunction with the site safety coordinator.

→ **Preliminary studies.** These make it possible to ensure the feasibility and profitability of removing the targeted elements with a view to transforming them into pavers or slabs. Given the experimental nature of the approach, it makes sense to rely on the advice of experts in the field, demolition and/or concrete cutting companies, as well as on feedback from similar constructive typologies.

→ **Removal.** Removal must above all aim not to damage the elements taken and to avoid any mixing. The degree of care and precision required must be proportional to the requirements relating to the use of the slabs and pavers. While some applications are relatively undemanding and accommodate speedy demolition techniques, others require significant care and specific removal.

Two main methods can be considered:

A. **Advance removal by clipping.** Clipping refers to the demolishing of a building from top to bottom. Each floor is demolished by small machines steered from the cabin or controlled remotely. The materials are generally discharged as they go through the elevator hoppers or through

a chute system. A lifting system is brought to the right of the building in order to transport operators and machines. In this approach, the elements to be recovered are made accessible as the demolition progresses. The operations required for cutting the walls and/or slinging the prefabricated panels must be taken into account in the site planning. Depending on the possibilities, the elements may be pre-cut directly to the required dimensions during their removal, this makes it possible to limit the volumes of materials to be shifted during removal.

B. **Collection upon demolition through picking with a mechanical shovel.** In this approach, the building is demolished more quickly and the elements to be recovered are taken from the rubble. This method has the advantage of not slowing down the demolition but turns out to be much more uncertain as to its results. In all cases, a mechanical sorting strategy for the demolition of the building must be established in consultation with the demolition company in order to guarantee a minimum of results, limit mixing and avoid rendering certain elements unusable.

→ **Transformations.** The production of pavers and slabs from more or less complete concrete elements (walls and whole slabs or fragments thereof) requires at least a treatment of the edges and a calibration to obtain a product in the desired shape and easy to install.

Fragments with very irregular shapes can be placed using an opus incertum apparatus. This makes it possible to limit the transformation operations to the treatment of the edges, which can be carried out in progress when laying the floor covering. When laying, however, the builders will have to make small adjustments between the different pieces. Therefore, this installation requires specific know-how. Compared to other stone-settings, it is relatively time consuming.

Orthogonal pavers and slabs can be obtained by cutting the original elements to the desired dimensions. Cutting can be done using a rail saw or a bridge saw with a rotating table. This last device allows movements on three axes and a greater flow. The implementation of such a device must be studied in detail.

*Note:* The use of a hydraulic cleaver as used for the production of natural stone pavers has not yet been tested for concrete. For large volumes, this solution may be of interest in terms of profitability. The way in which concrete behaves during such an operation remains however an unknown.

→ **Additional treatments.** Depending on the requirements relating to the intended use, pavers and slabs may be subject to additional treatments, in particular:

- **Surface treatment.** There are a multitude of surface treatments for concrete: bush hammering, polishing, shot blasting, etc. In the case of floor coverings, these treatments generally aim to reduce slipping. They can also be motivated by aesthetic reasons (highlighting the grains of concrete, for example) or to improve its durability (resistance to wear and fouling, for example).
- **Treatment of porosity.** To reduce the risk of concrete deterioration (especially caused by freeze/thaw cycles), the application of a pore filler or mineraliser can help make the concrete surface water repellent.

In all cases, the choice of these surface treatments must take into account any original coatings that may still be present on the paving stones and slabs.

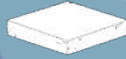

→ *Storage*. The slabs and pavers can be packaged on a pallet. Pay attention to the large mass of these elements. On a pallet, the elements must be held in place by means of a banding device and/or a heat-shrinkable or stretchable film (beware of packaging waste overproduction). The arrangement of the elements on the pallet must comply with the elementary rules of stability and regularity, in particular by not overloading.

The large sized elements can be superimposed on each other by inserting wooden wedges between each element.

Although they are inert by nature, for long periods of storage, it is recommended to protect the slabs and paving stones from bad weather (for example by tarpaulin or covered storage).

→ *Transport and delivery*. All necessary precautions must be taken during transport and delivery to limit falls and shocks (strapped pallets, etc.). Unless specific equipment is used, transport must be carried out flat. However, racks can be used, as wall formwork manufacturers do for on-site transport. The lifting means must be consistent with the dimensions and weight of the parts to be handled. It is advisable to involve specialised professionals to ensure the smooth running of these operations.

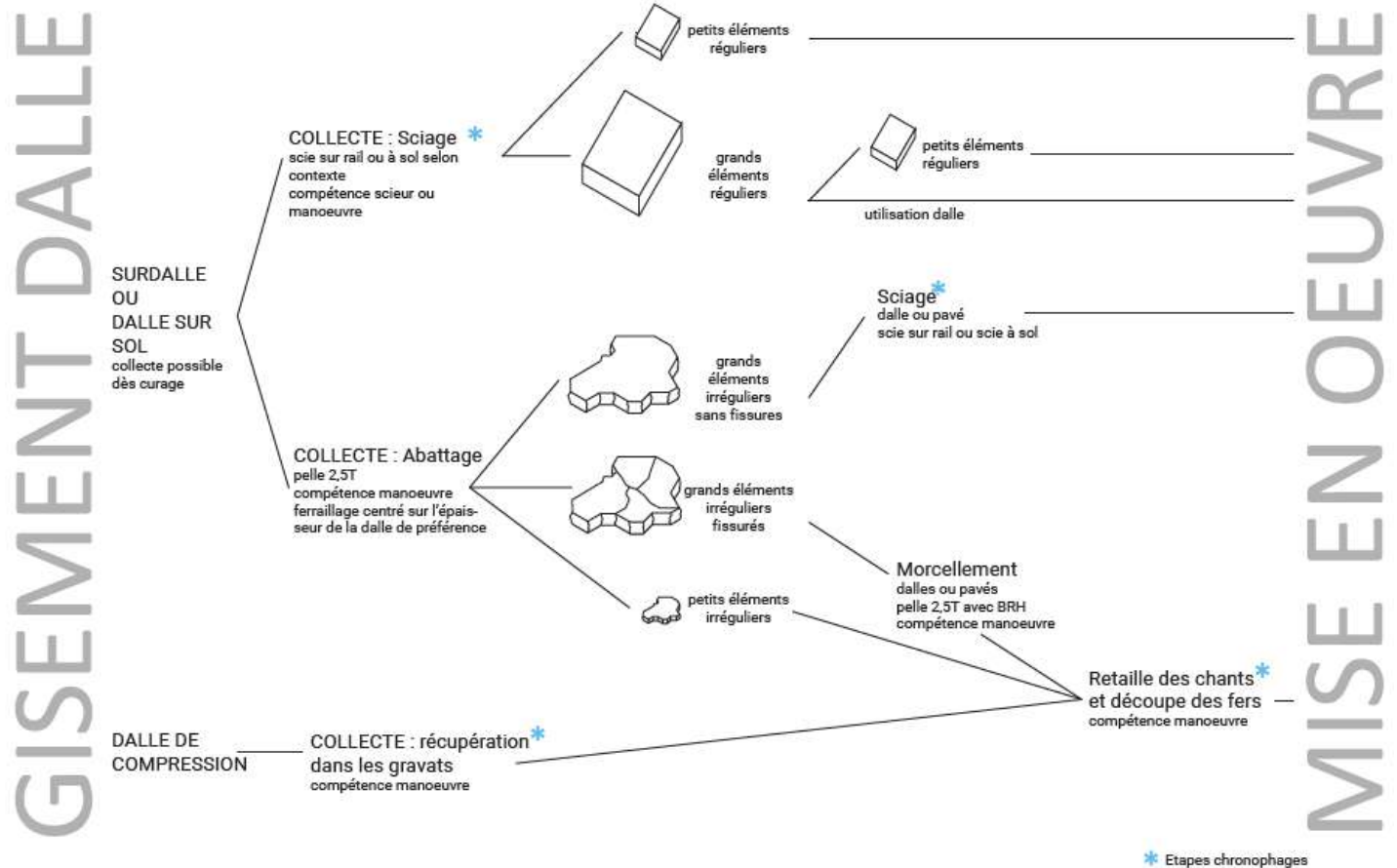
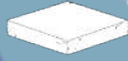

Figure 2. The steps from the concrete elements to the product, recovery of a compression slab. Control of the technical performance of concrete is carried out prior to the recovering operations. The control of the state of the materials is done at each stage of the process.





## Applications and installation

### Pavers or slabs resulting from the cutting of concrete construction elements are mainly used as exterior flooring.

Their installation must respect the same points of attention and the same regulations as their new equivalents, in particular - and non-exhaustively - with regard to slippage, durability, choice of installation methods, preparation of laying sub-structures, slope management, joint thickness, etc. Regulatory aspects are included in the following standards in particular: pavers for roads and public spaces: EN 1338 - Concrete slabs for roads and public spaces: standards of use, including EN 12371 - Natural stone test methods - Determination of frost resistance, EN 14231 - Natural stone test methods - Determination of the slip resistance, EN 1936 - Natural stone test methods - Determination of real density and apparent density, and of total and open porosity, and EN 13242 - Aggregates for unbound and hydraulically bound materials for use in civil engineering work and road construction.

To facilitate laying, the specifier will take care to use batches with a certain degree of uniformity in terms of the following characteristics:

→ **Batch composition.** The origin of the materials must guarantee the uniformity of their characteristics.

→ **Dimensions.** Opt for elements that are easy to handle. As an indication, a 20 to 40 cm diameter size, with two flat parallel faces, for a total mass of less than 25 kg is a good candidate. The use of large size slabs is not impossible but involves specific machinery and installation. Execution studies and dialogue with specialised companies should then be provided for.

#### Design tip!

When the constraints of use allow it, a dry installation is to be preferred to a sealed installation. This indeed offers several advantages: facilitate maintenance, preserve soil permeability and allow possible future reuse of the elements!

The thickness of the elements varies according to the operating loads and the mechanical characteristics of the concrete (which here depend on the materials collected).

Dimensional tolerance: the variation in thickness between the pavers must be < 3 mm.

The joint dimensions between pavers must be between 2 and 4 mm. A specific study should be planned if the thickness of the joints is greater than 4 mm. In general, the dimensions of the elements must be relatively uniform to ensure an acceptable joint width during installation.

→ **Colour.** The colour largely depends on the original concrete (generally in grey tones) and varies according to its quality, date and place of manufacture. Variations may also be due to the stresses during use, to the previously applied treatments, etc. Unless the project expressly requires the use of particular colours (for example, in the context of a heritage renovation), it is recommended to remain relatively open on this characteristic.

→ **Condition.** The reclaimed concrete pavers or slabs may have minor deterioration such as traces of superficial wear, stains, traces of mould, efflorescence, etc. In principle, these do not affect the suitability for use. On the other hand, the elements must not have any defect indicating a diversity in the structure, neither cracking, nor chipping, nor visible deformation or tearing, under penalty of disqualification.

→ **Quantity.** The loss of materials during the slab and paver extraction and production process should be studied in advance, in order to assess the end quantity of materials ready for installation.



The "Opus uncertum" of Clos Saint Lazare in Stains (FR), 2017. The concrete resulting from the demolition of a residential building built in 1959 was reused on site to cover the ground of the outdoor spaces.



### Characteristics and fitness for use

The requirements relating to the physical and mechanical characteristics are directly linked to the mechanical resistance over time of the paving stones and slabs, which largely depend on the qualities of the original concrete from which they are produced. Regarding the mechanical properties of modular concrete elements, the normative requirements (EN 1338 et EN 1339) relate to the following characteristics:

	<b>Use type 1</b> <i>Concrete pavers for garden</i>	<b>Use type 2</b> <i>Concrete pavers for roads and public spaces</i>	<b>Use type 3</b> <i>Concrete slabs for roads and public spaces</i>
<b>Breaking load per unit length (splitting failure test)</b>	X	X	X
<b>Flexural splitting strength</b>		X	
<b>Flexural strength</b>			X

<b>Characteristics</b>	<b>Comments</b>
<b>Dimensions (length, width), regularity of shape</b>	These characteristics are dependent on the cut. The irregularity of the pavers/slabs will influence the thickness of the joints during laying.
<b>Thickness</b>	<ul style="list-style-type: none"> <li>• Paver: minimum thickness of 60 mm for vehicular traffic;</li> <li>• Slab: for light traffic loads no minimum thickness is defined, but the requirements for flexural strength must be met;</li> <li>• The difference between 2 thickness measurements of the same slab &lt; 3mm;</li> <li>• The elements have straight edges, with a tolerance of +/- 1cm.</li> </ul>
<b>Surface quality</b>	Pavers with defects characteristic of non-uniformity of the structure, or with visible cracks, chipping, deformation or tearing must be rejected. Visual examination during demolition and/or checking with a Ferrosan.
<b>Impermeability/Water absorption</b>	Porosity according to EN 1936. Determining resistance to water absorption is not required for the first marking designation defined by standards EN 1338 and EN 1339.
<b>Flexural splitting strength</b>	The thickness of the concrete pavers must be estimated according to the compressive strength of the initial product. It should be noted that the concretes used in the building mainly belong to resistance class C25/30, which gives a resistance to the breaking load through splitting and through sufficient unit length so long as the thickness of the product is greater than 60mm.
<b>Freeze/thaw resistance</b>	<ul style="list-style-type: none"> <li>• No recommendation for use type 1 pavers.</li> <li>• No recommendation for pavers and slabs for use types 2 and 3 unless there are specific conditions such as frequent contact with de-icing salts (according to EN 1338 and EN 1339 standards).</li> </ul>
<b>Abrasion resistance (wear)</b>	The determination of abrasion resistance is not required for the first marking designation defined by EN 1338 and EN 1339.
<b>Slipperiness</b>	Slip resistance should be assessed, particularly if the surface of the pavers has been polished or ground. If not, surface treatments can improve this characteristic.
<b>Steel</b>	<p>Corrosion of any reinforcements in the paving stones resulting from the reclamation of concrete is not desirable. The following precautions should be taken:</p> <ul style="list-style-type: none"> <li>• Remove as many irons as possible when making modular elements;</li> <li>• Make the pavers in such a way that the residual reinforcement is placed horizontally in relation to the laying surface;</li> <li>• Ensure, by visual observation and via a phenolphthalein test that the reinforcement covering is sufficient;</li> <li>• When installing modular elements containing residual reinforcement, a dry installation allowing the development of possible corrosion is preferred, limiting the pressure on the joint and on the concrete.</li> </ul>

In the event of specific and demanding applications (i.e. high exposure to de-icing salts, high traffic class, etc.), characteristics such as mechanical resistance, frost resistance or impermeability can be measured using tests carried out by accredited laboratories.

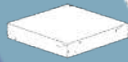

**Availability**

The pavers and slabs resulting from the cutting of concrete construction elements are not marketed products. To date, this is a strategy applicable to the scale of a project, by identifying a source site.

**Indicative prices (Excl. tax)**

The absence of an established commercial channel does not allow us to indicate the selling price of slabs and pavers. The cost of operations must be studied for each project, taking into account factors such as the quantity of materials involved, the complexity of the dismantling, the transformation operations required, the installation constraints, etc.

**Hazardous substances and precautions**

During documentary investigation, certain usage restrictions may be issued, in particular in the following cases:

- Presence of asbestos in coatings applied to concrete or in concrete. The study of the asbestos diagnosis upstream allows to control the presence of asbestos, in case of suspicion it is preferable to establish samples and a complementary asbestos diagnosis. As a general rule, during demolition, asbestos-contaminated surfaces are removed before demolition of the concrete.
- Concrete that has been subjected to chemical attack by soils and natural groundwater (corresponding to the three exposure classes XA1, XA2 and XA3 of standard EN 206).
- Possible presence of plaster residues in the concrete, a priori incompatible with reuse as a floor covering. In fact, the presence of water when using the pavers risks causing the formation of swelling mineral species such as ettringite, which may eventually cause deterioration of the paver or the slab.



*More info!*

*As an indication, the REPAR #2 study carried out in France in 2017 on a tangible case of on-site reclamation of concrete elements as exterior floor coverings (60 m<sup>2</sup>) demonstrated that this approach could lead to savings in the order of 10 €/m<sup>2</sup> excluding VAT. These results must however be interpreted in the light of the specific nature of the case study and of the assumptions taken into account to carry out the calculations.*

*Link (in French) : <https://www.bellastock.com/projets/repar-2/>*

**Embodied carbon (Cradle to gate - production A1-A3)**

	kg CO <sub>2</sub> eq./m <sup>2</sup>	kg CO <sub>2</sub> eq./kg
INIES databank (FR) - Individual declaration - PREFABRICATS LLEILDA SL - Exterior covering: paving stone (v.1.2) *	21.6	0.08
INIES databank (FR) - Collective declaration - SNBPE - Paving on a 0.15 m thick concrete platform, C25/30 XC1 CEM II/A**	49.8	0.14

\* 8 x 10 x 20 cm pavers. Transport distance: 400km

\*\* Transport distance: 18.5km, for a concrete paving 15cm thick. 30 kg of steel/m<sup>2</sup>. NB: the steel production steps (A1-A3) have been added, when these were not taken into account in the sheet



Depending on the sources, reusing 100 m<sup>2</sup> of concrete elements to create reclaimed concrete pavers and slabs prevents the equivalent production of ~ 2160 to ~ 4980 kg of CO<sub>2</sub> equivalent related to the manufacture of new elements (production phase only). According to sources, this corresponds to the emissions of a trip of ~ 12,950 to ~ 29,900 km in a small diesel car.



**Disclaimer**

This sheet is intended for designers, specifiers and other members of construction project teams wishing to reuse this building material or product. It is part of a collection of sheets aimed at bringing together the available information to date that is likely to facilitate the reuse of building materials and products.

This sheet has been produced by Bellastock within the framework of the Interreg FCRBE project - Facilitating the Circulation of Reclaimed Building Elements, supported by the entire project partnership. Sources of information include the experience of reclamation dealers and involved project partners, lessons learned from exemplary projects, available technical documentation, etc.

The sheets have been produced between 2019 and 2021. As the reclamation sector is evolving, some information, notably regarding pricing and availability, may change over the time. When the text refers to European standards, it is up to the project team to refer, if necessary, to their national implementations and local specificities.

It is important to note that the information presented here is not exhaustive or intended to replace the expertise of professionals. Specific questions are always project related and should be treated as such.

The complete collection of sheets (including the introductory sheet) is freely available from different reference websites (a.o. [opalis.eu](http://opalis.eu), [nweurope.eu/fcrbe](http://nweurope.eu/fcrbe), [futureuse.co.uk](http://futureuse.co.uk)).

Non-exhaustive directories of dealers in reclaimed building materials are available on [www.opalis.eu](http://www.opalis.eu) and [www.salvoweb.com](http://www.salvoweb.com).

---

Interreg FCRBE partnership: Bellastock (FR), the Belgian Building Research Institute / BBRI (BE), Brussels Environment (BE), the Scientific and Technical Center of Building / CSTB (FR), Confederation of Construction (BE), Rotor (BE), Salvo (UK) and University of Brighton (UK).

The information contained in this document does not necessarily reflect the position of all the FCRBE project partners nor that of the funding authorities.

Unless explicitly stated otherwise, the content of these sheets is credited in the Creative Commons Attribution NonCommercial – Share Alike format (CCBY-NC-SA).



Unless explicitly stated, the images used in this document belong to © Bellastock. Any other image has been the subject of a systematic request for authorisation from their authors or rightful owners. When this request has not been answered, we assumed that there were no objections to the use of the image. If you feel that this interpretation is unreasonable, please let us know.

**Iconography**

Figures 1 to 8 : Methodological and technical guide for the reuse of concrete in walls, Editor Etienne Prat, CSTB. Dans *REPAR#2 Le réemploi passerelle entre architecture et industrie*, mars 2018, BENOIT J, SAUREL G, BILLET M, BOUGRAIN F, LAURENCEAU S, ADEME, BELLASTOCK, CSTB.



## Concrete shear wall

### Material description

**Concrete walls or shear walls refer to parts of solid and vertical structures, in reinforced concrete, prefabricated or poured directly on site (shuttered concrete).**

Depending on their use, they can be qualified as:

→ *load-bearing* (or self-supporting) walls. They contribute to the stability of the building by supporting mainly vertical loads (e.g. exterior walls, crosswalls, etc.).

→ *non-load bearing walls*. They do not take up other loads than their own weight (e.g. interior partitions, etc.).

We talk of “shear” when the length of the element is equal to at least 4 times its thickness. The thickness varies according to the load to be taken up, with a minimum of 15 cm for walls exposed to bad weather. A thickness of between 10 and 15 cm may nevertheless be permitted on limited surfaces as long as it remains compatible with the constructive provisions for reinforcement.

*Interior* walls, such as crosswalls and walls located on either side of an expansion joint, are not exposed to rain. They differ from *exterior walls*, being impervious to the rain which is generally ensured by a waterproof coating.

In general, the walls recovered for reuse are in the form of rectangular panels up to 3 × 2m.

Shear walls are not very common products in the reclamation market. It is however possible to undertake a specific reclamation process, in the context of a given project and upon the initiative of the sponsors and designers.

Several architectural elements are likely to be reclaimed as concrete shear walls:

→ *the interior crosswalls cast in situ*. These are structural walls positioned inside buildings, perpendicular to the façade. The crosswalls work in compression and are generally lightly reinforced. The reinforcements are located to the right of the openings and at the ends of the walls. The fact that they have not been exposed to the elements facilitates their reclaim.

These walls have a variable thickness between 15 and 20 cm, their height most often corresponds to that of a storey, or about 250 cm in a housing building. The wall surfaces make it possible to produce elements of variable size according to the desired layout and the class of use. The surface thickness ratio must be taken into account.

→ *precast concrete panels*. The regular use of precast concrete elements appeared after the Second World War, in a context of large-scale reconstruction. Since there has been a wide variety of prefabrication processes, there is a wide variety of elements, including within the same building: variety of shapes, different thicknesses depending on the applications, variability of composition (density of the irons and reinforcements, with or without facing, multilayer or not, presence of an insulating layer inserted in the wall etc.).

In general, the greater presence of reinforcement (in particular in panels more than 10 cm thick) makes cutting of prefabricated panels more complicated. Wherever possible, the reclamation of the entire element is preferable. Thinner elements (for example, from interior partitions) are generally less reinforced and are more suitable for cutting.

Regarding the *finishing* of the concrete elements resulting from the reclamation, it is necessary to distinguish the condition of the surfaces after collecting the elements and the desired finishes during the material preparation phase for their reclaim.

The concrete elements are generally collected after cleaning, that is to say after removal of the finishing materials. To simplify, in a context of reusing concrete through recycling, the cleaning has as a particular objective, to remove all the non-inert materials which could degrade the quality of the concrete with a view to an optimal reclaim.

This stage site can therefore have an impact on the condition of the finished surfaces of the concrete.

In addition, the presence of dangerous substances (e.g. asbestos, lead), in most cases leads to the removal of these substances. Depending on their location, this work consists of removing coatings and sanding surfaces. Therefore, asbestos removal work also has an impact on the surface condition of the finished elements.

Thus, depending on the nature of the coatings, the demolition company's strategy, site conditions, the type of concrete finishes may vary. Taking into account the effects of the site makes it possible to refine the strategy for the surface treatment of the materials to be reclaimed.

Regarding the treatment of surfaces after collection and for reuse, the range of finishes is the same as that applicable to dry concrete: bush hammering, polishing, shot blasting, etc.



Prefabricated walls after stripping of interior linings and removal of asbestos from surfaces, before demolition or deconstruction of the building.



**Material reclamation**

**The recovery of concrete shear walls requires heavy mechanical means which can be those of the demolition site. Recovery depends on several factors: site constraints, location of elements in the building and desired result. It requires careful removal studies complementary to conventional demolition studies; the objective being to preserve the integrity of the elements in order to be able to reuse them. Certain steps must be anticipated, in particular if cutting is planned before demolishing the building, or if anchoring points must be installed to allow lifting of the elements to be collected, or even to expose so-called steel "keying" in order to separate prefabricated elements and allow their lifting.**

In all cases, it is a question of putting in place all the necessary precautions in conjunction with the site safety coordinator.

→ *Disassembly test* (or expert opinion). It makes it possible to ensure in practice the technical and economic tenability of the planned removal. Given the experimental nature of the approach, it is wise to rely on the advice of experts and concrete demolition and/or cutting companies, as well as on feedback from similar construction typologies.

→ *Diagnosis*. The diagnostic mission is generally organised in two phases:

1. Research and analysis of existing documents providing information on the structure to be demolished. This phase is completed by an on-site reconnaissance campaign.
2. Carrying out a survey on the elements. In the case of load-bearing walls, it is recommended to increase the number of tests and material identification to increase the reliability of the results.

*Together with the deposit results from the assembly of prefabricated elements, the analysis of the execution documents facilitates the location of keying zones and other connections.*

The objective of the diagnosis within the framework of reclaim of reinforced concrete is to have a representative image of the structure and its condition. For this, it is necessary to investigate the following:

- Visual inspection of the thickness of the reinforced concrete wall;
- Visual inspection of the condition of the reinforced concrete reinforcements and measurements of the diameters of the bars;
- Measurement of the carbonation depth. (i.e. carbonation is a chemical reaction causing natural ageing of concrete);
- Measurement of the reinforcement covering of the reinforced concrete and of their spacings. (i.e. the covering corresponds to the concrete thickness between a reinforcement and the skin of the wall. It ensures protection against corrosion of the reinforcement);
- Concrete compressive strength test;
- Tests of surface cohesion inclination and/or tearing (i.e. The surface cohesion of concrete is the pressure that allows the molecules to hold themselves together. It indicates the resistance to tearing of the surface layer of concrete. It measures the adhesion of repair products on concrete ).

Several criteria guide the choice and make it possible to check the potential of a batch of concrete shear walls for reclaim:

- *Reinforcement*. The density and distribution of the reinforcement can be assessed using existing documentation, a detector tool (ferroscan type) and soundings. Elements with concrete splinters caused by the oxidation of the bars in the concrete should be removed.
- *Thickness*. It is better if it is more than 16 cm, and the thickness difference between the panels is not more than 1 cm.
- *Straightness*. For rectangular prefabricated panels, the distance between parallel edges is preferably equal to a maximum of 1 cm or 5 mm/linear metre of distance between the edges concerned.
- *Integrity*. The elements must not show through cracks or with a thickness greater than 1 mm. They must be free of networks of generalised cracks which could presage a certain weakness.

- *Condition*. It is advisable to check the absence of spalling caused by an accidental impact on the facing or on the edge of the elements.

- *Accessibility*. The location of the elements to be dismantled in the building should be taken into account.

→ *Removal*. Removal methods vary according to the type, quantities and location of the elements to be recovered, as well as to the new use envisaged for the element. The important thing is not to damage the elements and to limit mixing. The removal method varies depending on whether it concerns prefabricated panels or cast-in-place walls. In all cases, we will seek to:

- optimise the relationship between the additional efforts to be made and the desired result.
- recreate the conditions for the installation of prefabricated elements: installation of lifting points (drilling or installation of rings).

To facilitate the careful removal of the panels, the clipping method, which consists of deconstructing the building from the upper level to the lower levels, is the most suitable. It allows placing machines and people in the building to prepare access to the elements to be collected. Additional lifting devices intervene for lifting from the ground to the right of the building.



Example of a concrete wall after nibbling removal  
© Alexis Leclercq





This way, the following method can be considered:

1. Removal of the upper floor holding the wall from the top, in order to free a hold for the wall.
2. Removal of the element by nibbling at the foot of the wall or by tearing off the wall at the top by tilting. The latter method is however to be avoided for load-bearing walls made of reinforced concrete. This practice leads to the plasticisation (i.e. exceeding the yield strength) of the vertical reinforcements at the foot of the wall, making them unsuitable for a new structural use.
3. Cutting. Before removal, it is possible to cut the panels, using a technique suited to the desired end product and handling. The time required for cutting must be included in the work schedule. For the removal of prefabricated walls, a simple stripping of the assemblies is sometimes sufficient without having to resort to cutting.
4. Lay the panels on the level, using a mini-excavator.
5. Resize items to desired final dimensions (Optional. This operation can be carried out later in the workshop).
6. Final collection upon bringing down, by lifting with a mechanical shovel equipped with a sorting basket (i.e. a sorting basket is a gripper consisting of two metal jaws whose contact surface is a straight line, which makes it possible to distribute the pressure exerted on the material and limit shocks).
7. Sling the elements to ensure more careful handling (Figure 1).



Figure 1. Example of a lifting system

At this stage, it is essential that the elements are marked and identifiable. Elements with different characteristics should not be mixed depending on:

- the orientation of the panel during lifting (cross or façade);
- the composition of the reinforcement (steel section);
- the covering (possibility of checking the contours of the panels);
- the carbonation depth (this parameter is likely to change during the storage period).

→ **Transformation operations.** The preparation of the elements depends on the new intended use. The operations carried out must particularly make it possible to ensure the solidity of the component and its durability.

- **Cutting.** Allows a rectangular panel to be obtained from a rough and irregular element. The straightness of the panels can be corrected so as to obtain the desired allowable deviation.
- **Repassivation of steel.** Passivation consists in making the reinforcing steel passive, through the application of a protective film, called passivation. This film protects the steel from corrosion. It is formed by the action of lime released by calcium silicates on iron oxide. Occasionally, it is possible to repassivate the steel if necessary. This requires chiseling away the adjacent concrete, then passivation of the steel and reconstitution of the cover layer. If the need for repassivation is widespread, it is best to discard the element.
- **Repairs.** Repair mortar can be applied to fill any splinters caused through collection or transport.

- **Preparation of the edges** (for a wall acting as a masonry wall). In the case where the shear resistance mode of the element makes use of the mortar junction between the edges of the panels and their support, it is possible to prepare the edges to give a rough appearance to the contours of the wall in order to increase grip. This operation can be done by chiselling.
- **Treatment of porosity.** To reduce the risk of concrete deterioration over time, particularly due to freeze/thaw cycles, it may be necessary to apply a product. This is a pore filler or mineralizer making the concrete water-repellent. These treatments can be carried out in the workshop or during installation.
- **Reinforcement sealing** (for a wall operating like a reinforced concrete wall). Reclamation for use in a reinforced concrete wall may require the sealing of reinforcement around the perimeter of the panel. This possibility must be studied with the manufacturer of the sealing system according to various parameters (thickness of the panels, tensile strength of the concrete, diameter of the reinforcements, etc.). The edges can be roughened by chiselling the periphery to promote shear resistance on the plane in question.
- **Surface treatment.** There are a multitude of surface treatments on concrete: bush hammering, polishing, shot blasting, etc. These operations can be carried out in the workshop or during installation.



Sawing of concrete walls before re-use  
© Alexis Leclercq



Sawing of concrete walls before re-use  
© Alexis Leclercq



## Concrete shear wall

→ **Storage.** Storage away from bad weather and without contact with the ground is recommended. The elements must be protected so as not to undergo premature ageing.

For flat storage, it is recommended to use battens interposed between each element.

For edge storage, rack type equipment will be used to meet the conditions set out above.

→ **Transport and delivery.** All necessary precautions must be taken during transport and delivery to limit falls and shocks (strapped pallets, etc.). Unless appropriate equipment is used, transport must be carried out flat. For on-site transport, racks similar to those used by manufacturers of formwork walls can be used.

The lifting means must be consistent with the items to be handled. Lifting can be done by crane, hydraulic excavator or telescopic handler. In the case of using machines that can move with the load, the material should be chosen on a case-by-case basis depending on the weight and geometry, terrain and lifting height.

The handling can be done by means of lifting devices which can, for example, be coupled with the concrete through chemical seals or expandable bolts. The anchoring must take into account the dynamic effects of handling.

It is advisable to involve specialised professionals to ensure the smooth running of these operations.



*Transport of concrete elements*

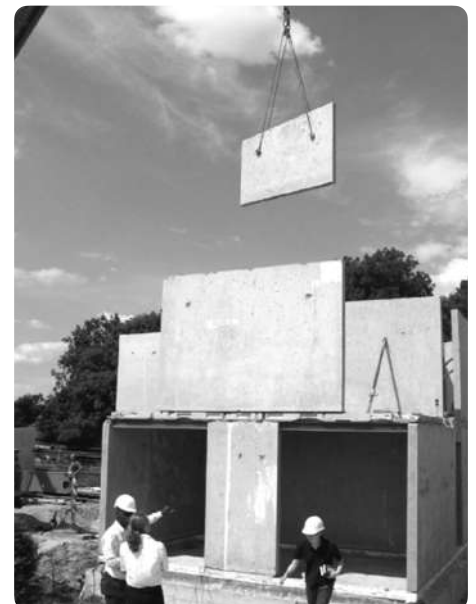

*The "plattenbau houses" Das Recyclete Haus. Built in the early 2000s in Mehrow (Berlin), these houses were constructed from prefabricated concrete slabs from the deconstruction of apartment blocks in East Berlin ("plattenbau"). The prefabricated slabs were removed and reused as floor slabs and load-bearing walls. © Bureau d'architecture Concluz.*



**Applications and installation**

Reference should be made to the ad hoc design standards (e.g. EN 1992), standards relating to new products (e.g. EN 14992 + A1, EN 13369, etc.) as well as the installation standards related to concrete products.

The reuse of reclaimed concrete elements may be suitable for the following applications:

- A. Non-load bearing panels
- B. Load-bearing panels
  - B.1. "Reinforced concrete" type function
  - B.2. "Masonry wall" type function

Before detailing the specifics of each type of application, here are some general principles that are applicable to the different scenarios:

→ **Original technique.** Installation techniques may differ depending on whether the recovered elements come from a cast-in-place wall or a prefabricated wall. This influences in particular the possible presence of reinforcement and of lifting and assembly points.

→ **Safety level.** From the point of view of the solidity of the designed structure, it is advisable to work with a satisfactory level of safety. The preparatory work of the materials must be adapted according to the condition of the elements taken, the scope of the diagnosis carried out, the results obtained during testing and their consistency.

→ **New use.** In the case of heated and inhabited rooms, it is advisable to study the water and air tightness of the wall as well as its sound insulation.

→ **Installation direction.** Several possibilities are to be considered depending on the installation techniques chosen (Figure 2):

- Straight installation: the element is installed in a similar arrangement to that in which it was taken.
- Installation on its edge: the element is tilted 90° from its original position and rests on a cut edge.
- So-called "disoriented" installation (only for "masonry wall" type function): the element is placed in a direction different from that of its original situation.

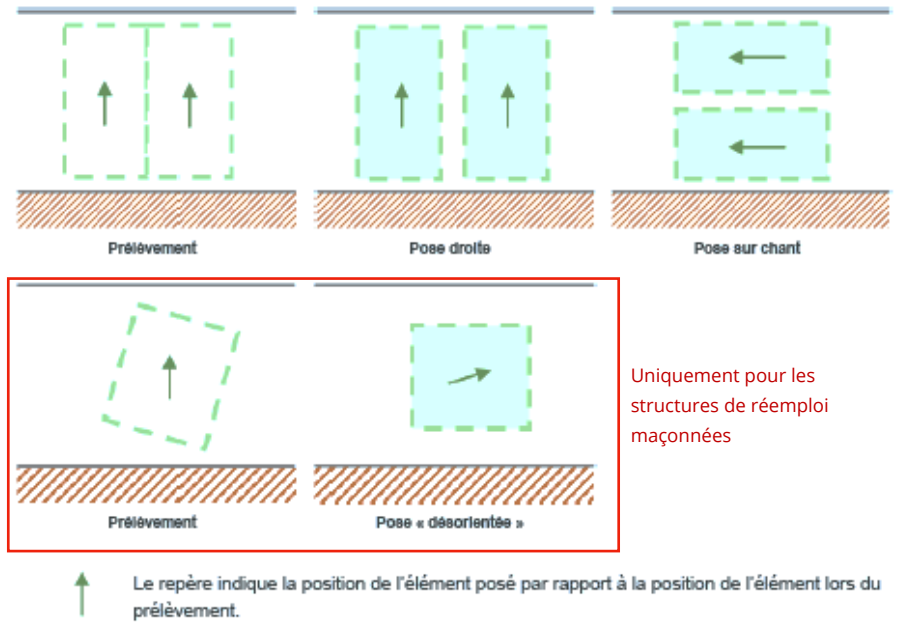

Uniquement pour les structures de réemploi maçonnées

Figure 2. Diagrams showing the different solutions for integrating concrete walls into a structure

To ensure the strength of the project and its sustainability,, the designer will take care to use batches with a certain degree of uniformity in terms of the following characteristics:

→ **Dimensions.** The collected elements are rectangular panels with an area of up to 2 × 3 m. The thickness of the panels must be uniform so as not to create a mismatch and be at least 16 cm. The permissible limits of the thickness difference between the panels must be observed. In the case of reclaimed panels, this limit of deviation between two parallel edges of a panel may be equal to 1 cm, or 0.5 cm/linear metre of distances between the edges considered.

→ **Hue.** Variations in colour and appearance are possible. These variations may be due to the production mode, original exposure, previously applied treatments, etc.

→ **Quantity.** It is advisable to include a surplus provision during the supply, to limit the risk of running out of material in the event that certain panels prove to be unsuitable for installation on the site.

**A. Non-load bearing panels**

In this case, the reclaimed panels must only be able to sustain their own weight. They play a filling role and do not contribute to the general stability of the structure. This implies that the walls are linked to the main framework of the building without however taking into account the stiffness of its structure.

Here are some ground rules for fastening panels to the building frame and to each other.

- **Direct fixing between the panels (Figure 3).** The panels can be installed upright on a flat, dry surface and secured by brackets or on a shrinkage-compensated mortar bed. The fixing between adjoining panels must prevent horizontal displacements (oblong holes). A vertical joint is made between the panels and filled with mortar without shrinkage. The coating layers should be properly reconstituted. It is advisable to limit installation to a maximum of 3 consecutive panels, with a cumulative length of non-load bearing panels of 5 m at most between elements of the primary framework.





• *Fixing by interposed metal clamping profiles (Figure 4).* This solution consists of fitting and bolting panels into vertical metal profiles, in the manner of soldier-pile walls. The recommendations are the same as for the direct fixing system, except that:

- the joint formed between the panels and the metal profiles is a dry joint;
- the non-visible section has previously had a levelling mortar for the reconstitution of the coating layers;
- it is necessary here to provide oblong holes in the vertical metal elements in order to free the horizontal displacements;
- installation is limited to a maximum of 2 consecutive panels.

• *Treatment of corners and ends of walls (Figure 5).* For brackets and angle fixings between panels, oblong holes are provided on the two sides on the inside. The corners and the ends can be processed with square section hollow profiles on which metal plates are welded on the outer faces. This plate is bolted to the panels and provided with oblong holes. The coating of the vertical slices of the panels is reconstituted beforehand with mortar for the protection of the visible reinforcements after cutting. A square or rectangular metal profile and of width equal to the thickness of the panel is arranged at the end of the panel to fix it. Metal plates are welded to the profile and bolted through the non-load bearing panel.

These assembly techniques are particularly suited to steel frames. These ground rules can also be adapted to timber and concrete frames. The important thing is to connect the reclaimed panels so that they are not part of the building's bracing.

### **B.1. Load-bearing walls of the "reinforced concrete" type**

In this approach, it is necessary to ensure the monolithic character of the wall. The behaviour of the new wall will then be comparable to that of a shuttered concrete wall. For this, it is necessary to connect all the elements before keying.

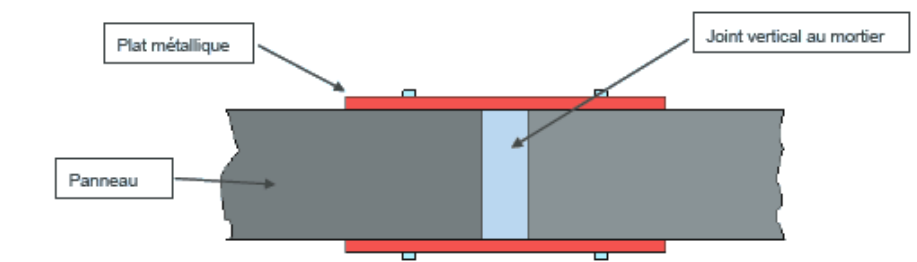

Figure 3. Direct panel to panel fixing solution

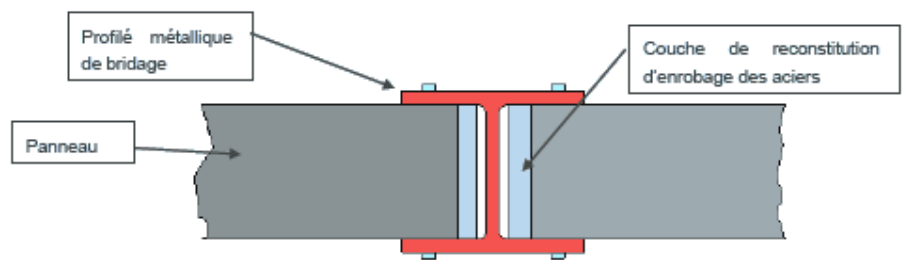

Figure 4. Clamping solution with metal profiles

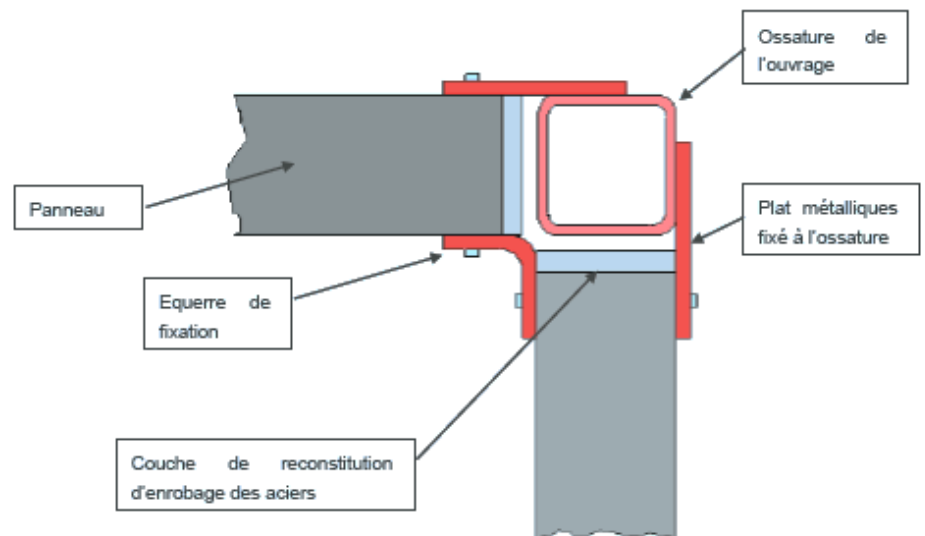

Figure 5. Treatment of corners

Density of the reinforcement in both directions must be known and included in the dimensioning of the structure. Overlapping reinforcements are sealed around the entire perimeter of the panels to ensure the monolithism of the wall and the overlapping of the perimeter reinforcements. Calculations must comply with EN 1992 (Eurocode 2).

When the wall is part of the structure's bracing, the checks include all the joints between panels. The use of irregular panels can make this operation complex. *Figure 6* illustrates a possible fixing solution.

As a common part of the panels collected, it is necessary to ensure that the coating of the reinforcements is satisfactory, even if the reinforcements do not impinge on the performance of the structure.

In this design mode, the contours of the panels are systematically coated and in direct contact with the keying concrete. Concreting with a glazed panel surface will encourage the penetration of water, for which it is necessary to provide for the evacuation of excess water.

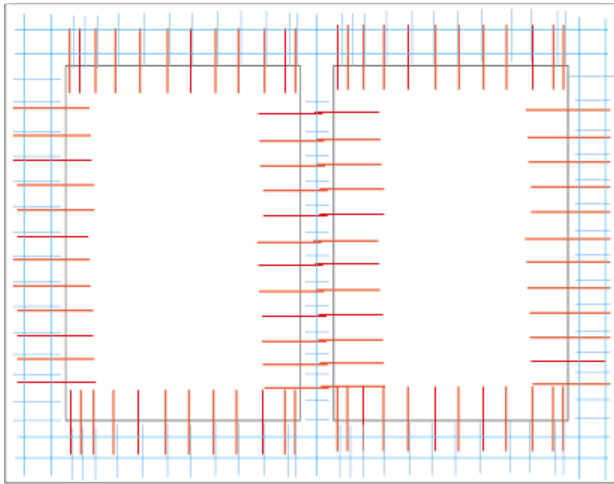

**Legend:**

(In white): re-used panels

(In red): reinforcement sealed on the perimeter of the panels to ensure continuity in the transmission of forces between the reinforcement of the re-used panels and the reinforcement of the perimeter installed.

(In blue): overlapping reinforcement placed on the site, for the creation of a monolithic wall.

Figure 6. Example of the construction of a reinforced concrete wall from reclaimed concrete panels

**B.2. Load-bearing walls of the "masonry wall" type**

In this approach, the reclaimed panels constituting the wall are confined and surrounded by vertical and horizontal wall ties. The wall consists of one or more panels installed so as to allow the creation of a compression link in order to ensure the resistance of the wall to horizontal forces. In the behavioural modelling of reinforced concrete, the compression link is the zone of compressed concrete, generally obliquely to the principal directions of the element.

Non reinforced elements can be used for this type of installation.

The panels are placed on a bed of mortar and propped up before installing all the wall ties. The straightness of the panels must be checked so that they can work with a consistently thick bed of mortar.

It is crucial that the panels adhere correctly to the mortar layer of the wall ties in order to guarantee good resistance to shear stresses (which can be estimated using §6.2.5 of standard EN 1992 - Eurocode 2). However, once cut the panels have edges with a glazed appearance, which are not very conducive to adhesion. From there, two main approaches are possible:

- *Rough edge joint reinforcement (Figure 7).* Once cut, the edges are subject to specific preparatory work, for example by chiselling, in order to ensure a certain roughness (see § Material recovery). In this case, it is possible to estimate the initial shear strength, noted  $f_{vk0}$  from table 3.4 of §3.6.2 of EN 1996 - Eurocode 6.
- *Joint reinforcement with assembly by metal plates (Figure 8).* If the adhesion between the blocks is not proven or without prior qualification tests, connections by means of metal plates can then be considered. This approach is particularly interesting when it is necessary to guarantee a high resistance to shear (e.g. if the wall is part of the bracing or the resistance to seismic action).

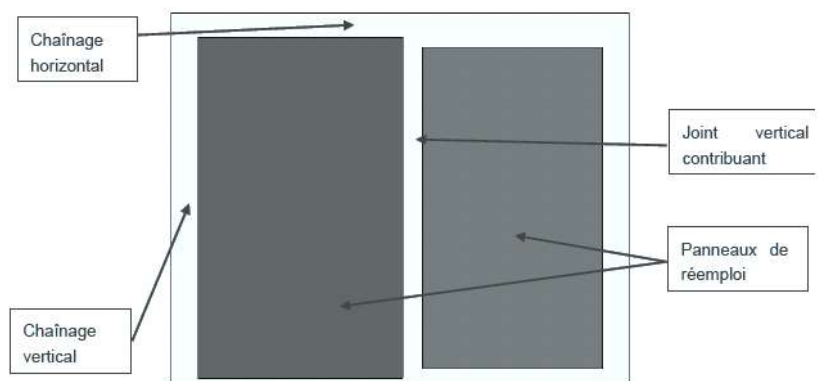

Figure 7. Rough edge joint reinforcement

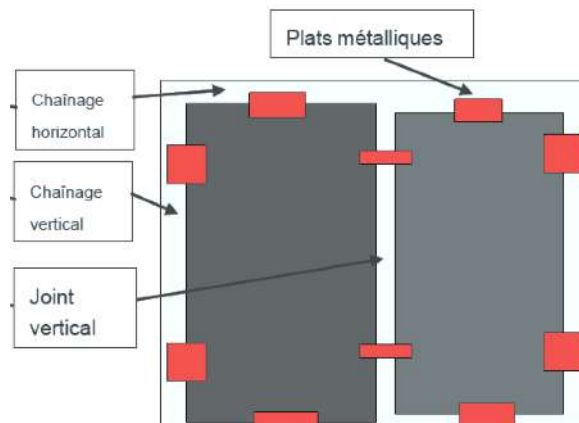

Figure 8. Joint reinforcement with assembly by metal plates

**Characteristics and fitness for use**

The requirements relating to the physical and mechanical characteristics are directly linked to the mechanical strength and durability over time of the reclaimed panels.

Characteristics	Load-bearing	Non load-bearing	Comments
<b>Dimensions (length, width), regularity of shape</b>	x	x	These characteristics are are linked to the cutting.
<b>Geometric requirements</b>	x	x	<ul style="list-style-type: none"> <li>• Length: <math>30\text{ cm} &lt; L &lt; 200\text{ cm}</math></li> <li>• Width: <math>30\text{ cm} &lt; w &lt; 50\text{ cm}</math></li> <li>• Thickness: <math>16 &lt; t &lt; 40\text{ cm}</math> with a variation between elements of 6mm max</li> <li>• Straightness</li> <li>• Parallelism of opposite edges</li> </ul>
<b>Mechanical requirement</b>	x		$2400\text{ kg/m}^3 < \rho < 2500\text{ kg/m}^3$
<b>Surface quality</b>	x	x	Panels with crack openings $> 1\text{ mm}$ , through cracks, or a network of cracks are rejected.
<b>Design and strength</b>			<p>The wall must be able to support its own weight and the loads at the top of the wall.</p> <p>-&gt; <i>Load-bearing panels:</i></p> <ul style="list-style-type: none"> <li>• The initial shear strength <math>f_{vk0}</math> can be estimated from table 3.4 of §3.6.2 of EN 1996 - Eurocode 6;</li> <li>• The length between two supports will be at most equal to half of the bottom length of the wall;</li> <li>• The faces glazed through cutting and revealing reinforcements may be placed on the visible side provided that the visible ironwork is treated</li> </ul> <p>-&gt; <i>Non-load-bearing panels:</i> the structure in which the non-load-bearing panel is integrated cannot rely on the former to justify its stability. It will be necessary to provide a clearance between the panel and the framework, in order to separate that of the framework, so that it does not aid its stiffness. In addition, integration into the structure must make it possible to justify the stability of the reclaimed element, in particular between collected elements and the primary framework.</p>
<b>Sustainability</b>	x	x	<ul style="list-style-type: none"> <li>• If the carbonation depth exceeds the cover depth divided by 2 then a mortar repair is necessary.</li> <li>• If corrosion has already occurred, purging of the adjacent concrete followed by passivation of the steel before reconstitution of the cover layer is necessary. This process cannot be envisaged on a large scale.</li> <li>• It should be ensured that the coating of the reinforcements is sufficient along the joint.</li> <li>• The outlines of the panels and the joints of the panels must be covered with mortar (installation of a hollow joint to make them invisible)</li> </ul>
<b>Waterproofing</b>	x	x	The waterproofing criteria are similar to those of a solid concrete wall. Particular attention should be paid to the waterproofing of the joints.





## Concrete shear wall

Characteristics	Load-bearing	Non load-bearing	Comments
<b>Performance in case of fire</b>	x	x	<ul style="list-style-type: none"> <li>• Incombustible</li> <li>• The resistance (R), waterproofing (E) and insulation (I) criteria are those of a reinforced concrete wall. These checks come under standard EN 1992-1-2 - Eurocode 2.</li> <li>• The resistance can be increased or justified by the application of a plaster-board type top coat.</li> </ul>
<b>Sound reduction</b>	x	x	<ul style="list-style-type: none"> <li>• Similar to that of a regular concrete wall with full joint.</li> <li>• Same regulatory submission and justification by acoustic assessment of the system.</li> </ul>



*Super Local Project. This experimental project carried out in 2017 in the Netherlands implemented a reclaim process of three-dimensional concrete modules extracted from an old housing building, for the construction of individual houses. The modules consist of slabs and walls, which were sawn before being crane-mounted and transported by truck to the nearby reclaim site. Client: HEEMWonen. Architect: SeC Architects. Contractor: Jongen Construction. Research unit: Zuyd University of Applied Sciences, Research group SURD.*



*The pavilion of the Fabrique du Clos in Stains. During the demolition of a housing complex in Stains, some of the concrete elements were reclaimed on the site. The extracted concrete walls were sawn on site and reused as non-load-bearing walls for a bicycle room. The paving of the floors of the outdoor areas was also made from raw concrete blocks. Contracting authority: Seine-Saint-Denis Habitat. Design: Bellastock. Stains (France), 2017 © Alexis Leclercq*



**Find out more!**

According to the REPAR # 2 study carried out in France on a concrete and specific case of the reuse of a concrete shear wall on site for the construction of a small pavilion, the comparison between a reclamation process and two new processes allowed the following conclusions to be drawn on an economic level:

→ the cost of the constructive solution based on re-claim is approximately 7% higher than a constructive solution based on the disposal of old materials and the installation of new solid bricks, and nearly twice as much as in the case of new solid concrete blocks.

These results are mainly linked to the numerous transformation operations of reclaimed materials. The high costs convey the experimental approach and could greatly decrease in a logic of replicability on a larger scale. Several areas for improving the reclamation process have also been identified:

- Optimisation of the material collection process, so as to limit losses during the removal of the elements on the one hand and to avoid panel pre-cutting costs on the other hand;
- Decrease in design costs;
- Reduction in the time spent linked to the use of technical means specific to the experiment (hydraulic crane in the reconstruction phase);
- Reduction of the fixed costs linked to the passivation of exposed iron, by using mortar in the event of non-carbonation of the steel.

By taking these factors into account in an optimized scenario, a 30% reduction in the cost of the reclaimed structure is possible.

Link (In French): <https://www.bellastock.com/projets/repar-2/>



**Availability**

Shear walls are not very common products in the reclamation market. It is however possible to undertake a specific reclamation process, in the context of a given project and upon the initiative of the sponsors and designers. For this reason, the supply of concrete walls is done directly from a demolition operation.

**Indicative prices (Excl. tax)**

The lack of an established channel does not allow precise pricing of reclaimed panels to be defined. In general, the price of a panel will depend on factors inherent to the source site (number of elements to be collected, complexity of the dismantling, planned application, etc.) and to the installation context.

**Hazardous substances and precautions**

During documentary investigation, certain usage restrictions may be issued, in particular in the following cases:

→ Concrete that has been subjected to chemical attack by soils and natural groundwater (corresponding to the three exposure classes XA1, XA2 and XA3 of standard EN 206).

→ Possible presence of asbestos on the surface of the concrete wall (fireproof insulation on the façade, joint, interior coating glue, etc.). Prior asbestos removal from the building can make it possible to clean the concrete elements of asbestos residues, a concrete element having been in contact with asbestos should not automatically be disqualified for reclaim at the diagnostic stage.



According to the sources, reusing 100 m<sup>2</sup> of concrete elements to create reclaimed concrete shear walls prevents the equivalent production of ~ 2030 to ~ 3770 kg of CO<sub>2</sub> equivalent related to the manufacture of new elements (production phase only). According to sources, this corresponds to the emissions of a trip of ~ 12,200 to ~ 22,600 km in a small diesel car.

**Embodied carbon (Cradle to gate - production A1-A3)**

	kg CO <sub>2</sub> eq./m <sup>2</sup>	kg CO <sub>2</sub> eq./kg
INIES database (FR) - Collective declaration - SNBPE & Reinforcements - Concrete (excluding reinforcements) for exterior post, C2530 XC4XF1 CEM IIA (v.1.1) *	20.3	0.06
INIES database (FR) - Collective declaration - SNBPE - Reinforced concrete for cross or interior concrete wall, C20/25 XC1 CEM II / AS. **	32.4	0.08
INIES database (FR) - Collective declaration - SNBPE - Exterior concrete wall 0.16 m thick, C25/30 XC4 / XF1 CEM II / A (v.1.5) **	37.7	0.08

\* Indicative value for concrete shear wall with a steel density of 18.5 kg/m<sup>3</sup>. Average material transport distance: 18km

\*\* Indicative value for concrete wall with a steel density of 50 kg/m<sup>3</sup>. Average material transport distance: 18km. NB: the steel production steps (A1-A3) have been added, when these were not taken into account in the sheet.



